





A CUT ABOVE THE REST

BLUEDIAMOND IMPLANT

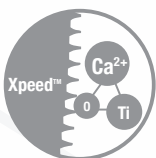
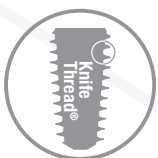

MegaGen never stops developing....
for lifetime smiles





BLUEDIAMOND goes FAR BEYOND
the standard expectations
for dental implants...

CONTENTS

04	Philosophy behind BLUEDIAMOND® implants
05	Characteristics & Advantages
16	Fixture Sizes & Packaging
16	I . Fixture Sizes
19	II . Packaging
20	Cover Screws & Healing Abutments
23	Abutment & Prosthetic Options
23	I . Fixture-level Prosthesis
31	II . Abutment-level Prosthesis
51	III . Overdenture Prosthesis
66	BLUEDIAMOND Kits
66	I . Surgical Kit
75	II . Prosthetic Kit
77	III . Bone Profiler Kit
78	IV . Optional Components
82	Digital Dentistry
82	I . MegaGen Digital Workflow
84	II . R2GATE®
86	III . R2 GUIDE™
88	IV . R2 Surgical Kit
92	V . Anchor Kit
94	VI . Digital Abutment & Prosthetic Options

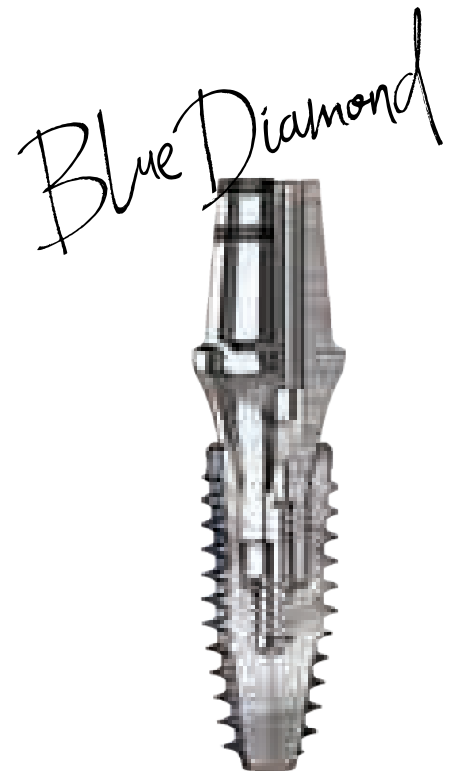

What makes BLUEDIAMOND a cut above the rest?

For clinicians

- Minimally invasive
- Fast & simple
- Predictable & excellent esthetics
- Mechanical, biological & long-term stability

Blue [blu:]:
a masterpiece of
implant technology

For patients

- Painless fast treatment
- Functional & esthetic new teeth
- Strong & long-term use

Blue Diamond



BLUEDIAMOND goes FAR BEYOND standard expectations of dental implants...

Advanced implant system for the digital age

BLUEDIAMOND® implants are MegaGen's premium implant system based on a new loading protocol with proven results from over 10 years. Leveraging all the strong points of AnyRidge, BLUEDIAMOND® implants have been enhanced to provide a long-term solution to the mechanical and biological complications that are currently challenging implant dentistry.

With an ever increasing number of users around the world, BLUEDIAMOND® implants enable fast implant treatment and provide patients with excellent new teeth that are esthetic, functional and long-lasting.

- Excellent initial stability in any bone density
- Faster & stronger osseointegration
- Proven stability of surface treatment
- Less reduction & more preservation of cortical bone
- Wider implant possibilities than crestal width
- No changes in alveolar crest
- Minimal retraction of peri-implant marginal gingiva
- Aesthetic design for prosthesis
- Precise implant-prosthesis connection
- Minimized screw loosening
- Convenient surgical kit

Biologically-inspired design: A new design standard on the global stage

Since the release of the biologically-based AnyRidge implant system in 2009, AnyRidge has gained worldwide attention as a "Game Changer" and 'New Standard' for a successful implant, producing more successful clinical outcomes than even expected by the original developers.

A CUT ABOVE THE REST

BLUEDIAMOND

IMPLANT

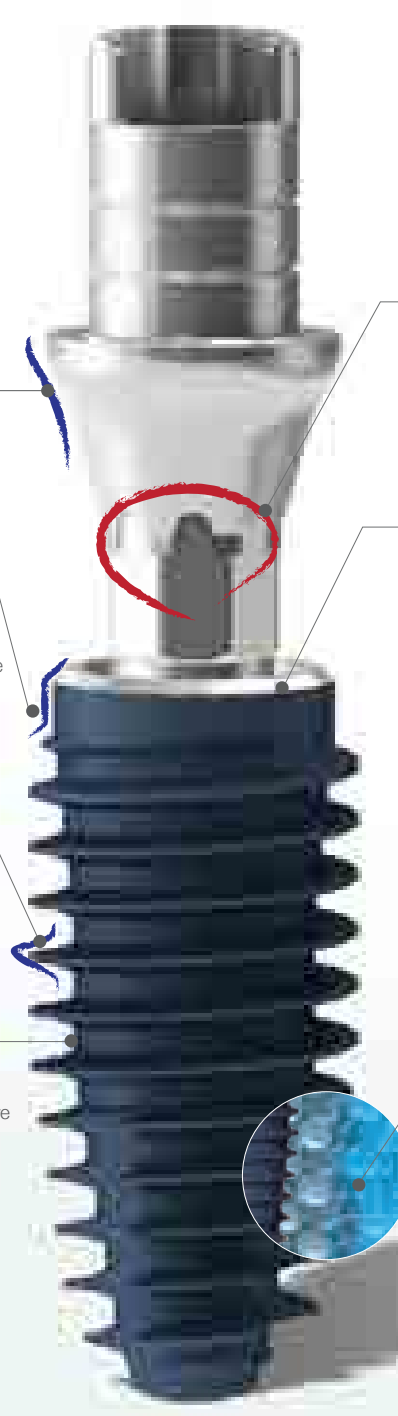

Biologic S-line
Beautiful & natural-looking esthetics

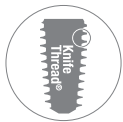

Designed for less bone stress
Maximum preservation of cortical bone

Higher initial stability in any bone condition
Deep thread & KnifeThread® design ensure high stability even in soft bone



Digital planning becomes reality
Octa position selection enables more accurate positioning



Feel the X-FIT moment!
First with Octa, then with Keystone
More precise positioning & connection



Targeting zero fractures
200% increase in compressive strength via scientific design (Comparison with major domestic fixtures)

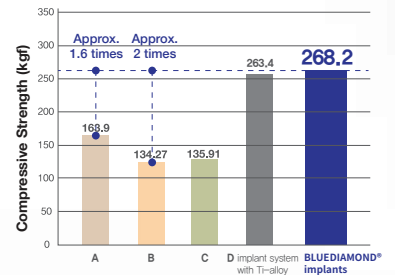

Pure titanium body
Long-term biological stability with over 20 years of clinical evidence

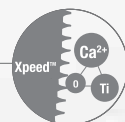

XPEED®
Nano bone matrix layer of Ca²⁺-incorporated S-L-A surface
Excellent, rapid & long-lasting osseointegration

Stronger than any other implant

Same long-term biological stability Targeting zero fractures due to higher strength

BLUEDIAMOND® implants are made of pure medical Grade 4 titanium (coldworked) that has been clinically proven for more than 20 years to provide biocompatibility and ensure long-term survival when linked to an implant design with improved strength. Notably, combining a higher compressive strength and fatigue strength safeguards the long-term mechanical stability of the implant.

Optimized design is the key to long-term mechanical safety.

- 1) Optimized thickness & external shape of fixture/abutment wall
 - 2) Optimized shape & diameter of abutment screw
 - 3) Optimized shape & contact area of fixture/abutment connection
 - 4) Selection of titanium material to improve overall strength
- When optimized, the overall strength is improved

BLUEDIAMOND® implants are made of pure titanium and have an optimized structure and shape that result in a higher compression and fatigue strength when compared with implants made of titanium alloys.

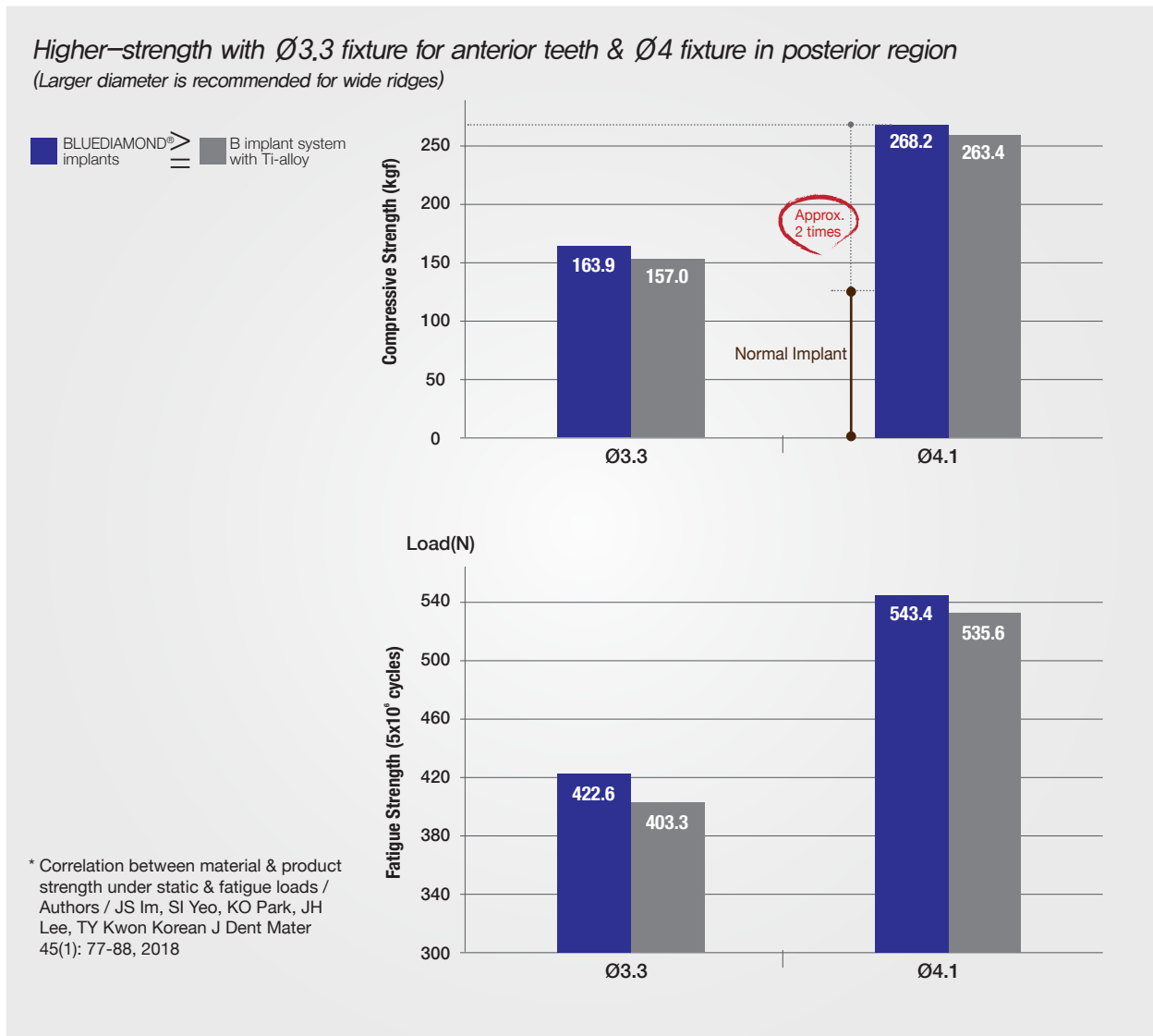

High initial stability for immediate placement in all bone types

KnifeThread® guarantees sustained implant stability

The unique KnifeThread® and super self-tapping design features provide superior initial stability in any compromised bone situation, including bone condensing, gentle ridge expansion, maximized compressive force resistance, and minimized shear force production.

1. Stable dispersion of stress with buttress thread shape
2. Easier insertion with sharp thread shape
3. Round face has larger surface area than straight face

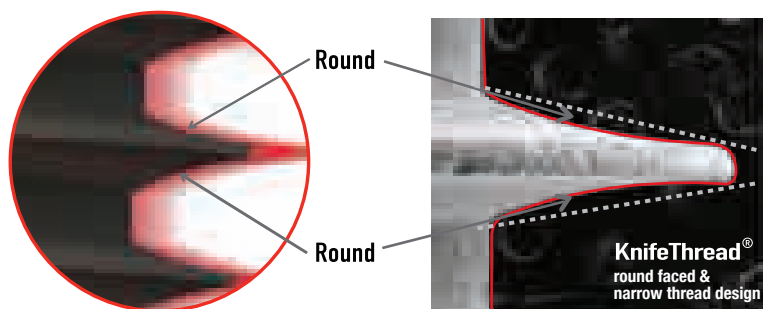

- Excellent initial stability
- Excellent BIC
- Special cutting efficiency during implant placement
- High resistance to compressive force
- Minimized occurrence of shear force
- Large surface area for osseointegration

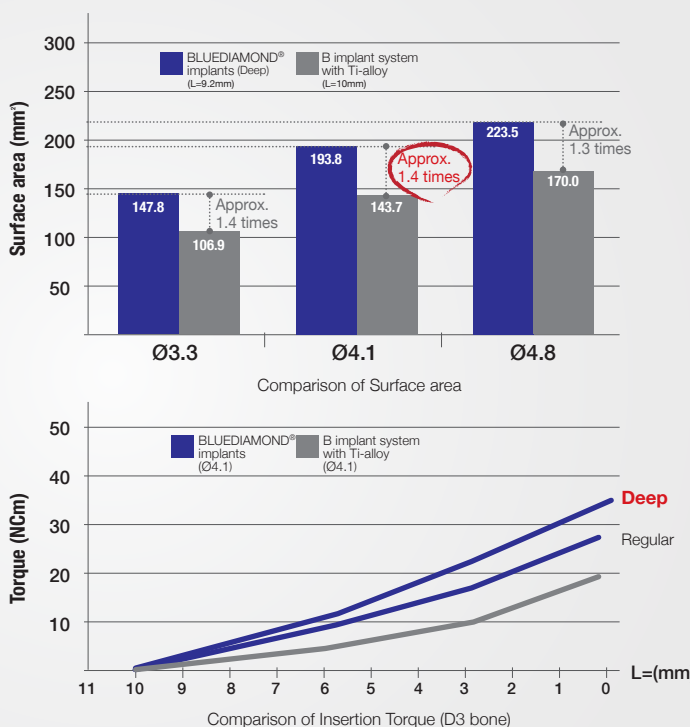

*R&D center in MegaGen Implant Co.,Ltd.(2017)

High ISQ value on day of placement in any bone density

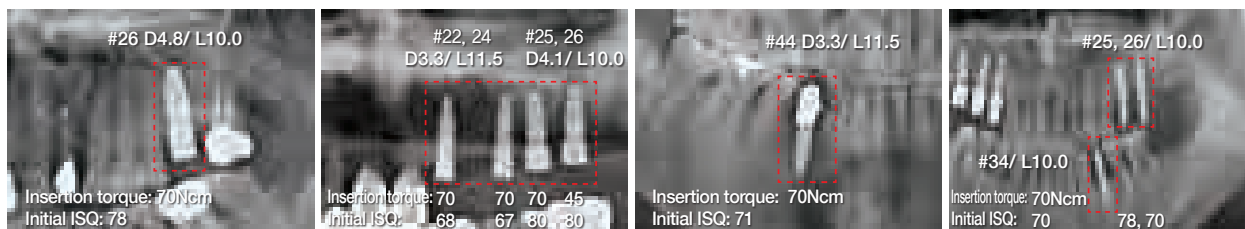

Fixture thread options for better initial stability

The option of different thread depths (regular or deep) and special KnifeThread® design enable easy implant placement with good primary stability in ALL bone densities

- REGULAR thread recommended for hard bone (D1 & D2)
- DEEP thread recommended for soft bone or poor bone density (D3 & D4)

	Fixture Diameter								
	Ø3.3	Ø3.7	Ø4.1	Ø4.4	Ø4.8	Ø5.3	Ø5.8	Ø6.3	
Regular Thread									
Thread Depth	0.4	0.4	0.45	0.45	0.4	0.45			
Deep Thread									
Thread Depth	0.6	0.6	0.65	0.6	0.65	0.65	0.9	1.15	

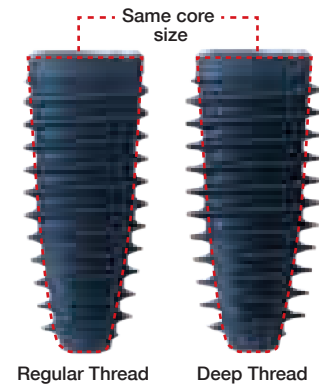

Coming soon!

Regular & Deep Threads

Fixture Diameter	Apical Diameter (Regular & Deep Thread)	Core Diameter	Thread Depth (Regular Thread)	Thread Depth (Deep Thread)	Length(mm)	Connection Diameter
Ø3.3	Ø1.1	Ø2.8	0.4	0.6	7 / 7.7 / 9.2 / 10.7 12.2 / 14.2 / 17.2	Ø2.8
Ø3.7	Ø1.4	Ø3.2	0.4	0.6		Ø2.8
Ø4.1	Ø1.9	Ø3.5	0.45	0.65		Ø3.3
Ø4.4	Ø2.1	Ø3.8	0.45	0.6		Ø3.3
Ø4.8	Ø2.4	Ø4.2	0.4	0.65		Ø3.3
Ø5.3	Ø2.7	Ø4.7	0.45	0.65		Ø3.3
Ø5.8	Ø2.7	Ø4.7		0.9		Ø3.3
Ø6.3	Ø2.7	Ø4.7		1.15		Ø3.3

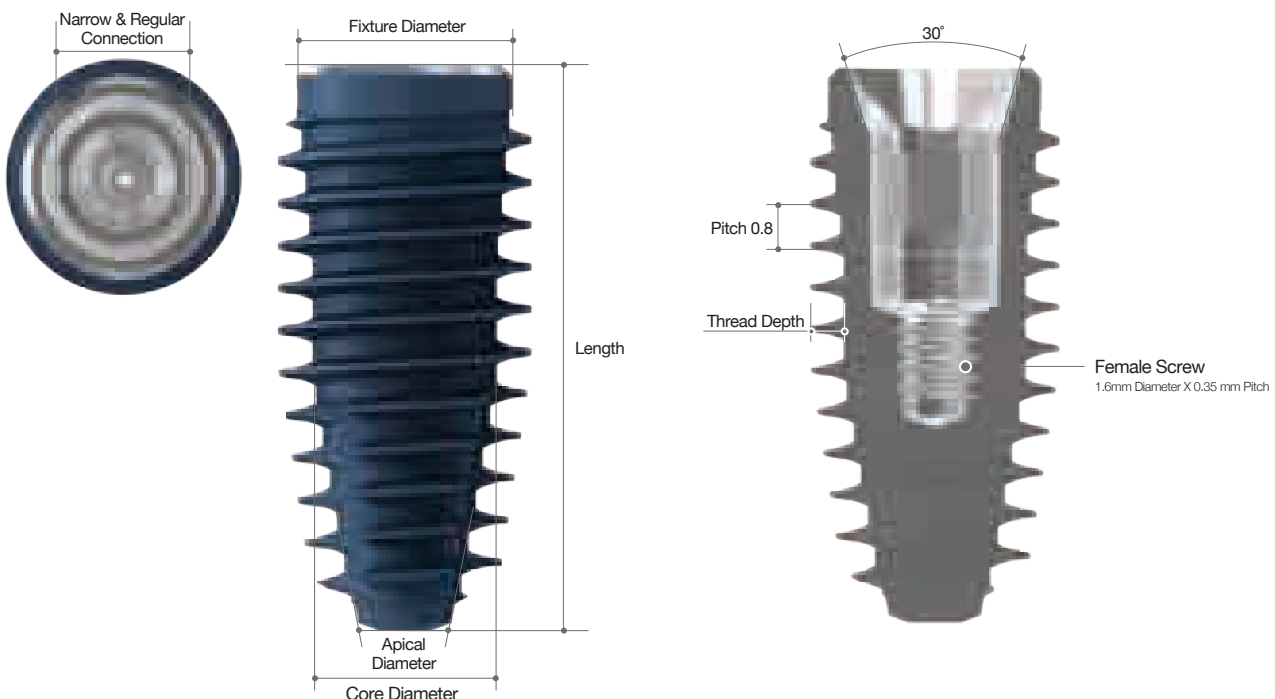

Designed to be minimally invasive

Maintains more existing bone for better long-term prognosis

Thread-less section for maximum preservation of cortical bone

- * More cortical bone
- = more soft tissue
- = beautiful gingival line

BLUEDIAMOND® implants do not rely on cortical bone for initial stability. By reducing the stress applied to the cortical bone, this prevents bone resorption that occurs after fixture placement.

The coronal design of BLUEDIAMOND® implants preserves more cortical bone around the fixture, resulting in a beautiful gingival line, along with fast and strong osseointegration.

Narrow apical diameter allows placement of wider fixture in narrow crest

The narrow apical diameter of BLUEDIAMOND® implants allows a wider fixture to be placed via a narrow alveolar crest, while preserving the surrounding hard & soft tissue (minimally invasive).

BLUEDIAMOND® implants have a relatively high strength compared to their diameter, providing sufficient strength even in a narrow ridge.

Insertion of longer fixture

The narrow apical diameter also reduces the risk of touching sensitive anatomy (nerves), allowing the placement of longer fixtures.

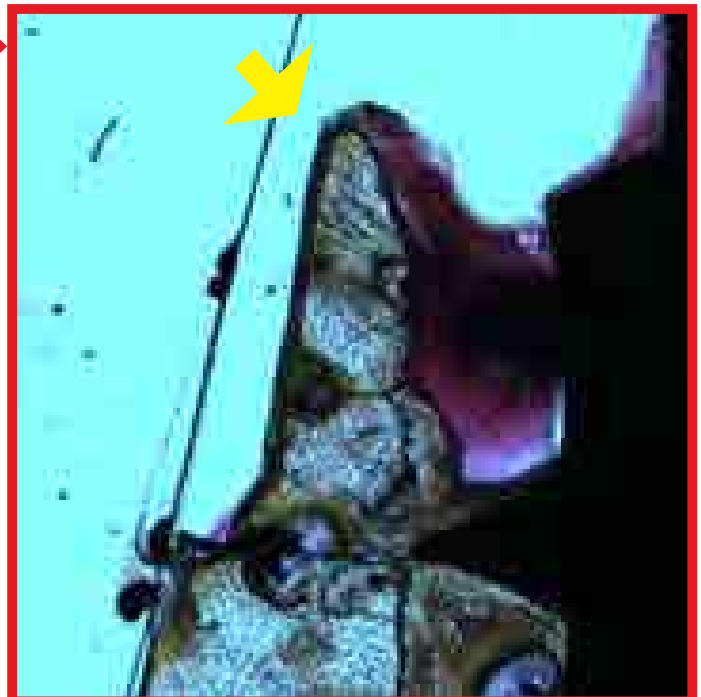
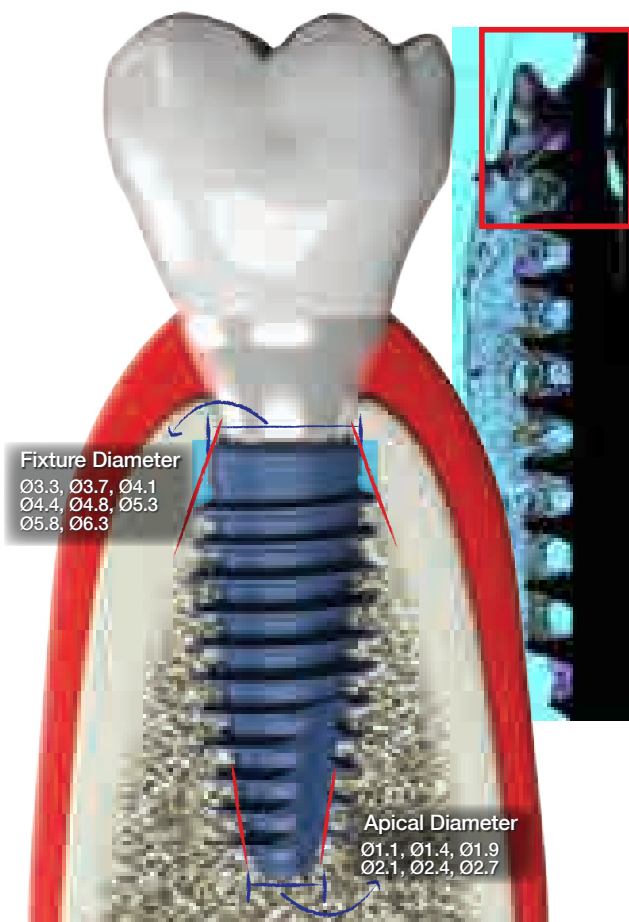

- Human biopsy 2.5 yrs after placement
- Yellow arrow shows preserved pointed alveolar crest after implant placement
- Even with narrow ridge, no peri-implant marginal gingival recession is seen 2.5 yrs after implant placement

Immediately high & sustained ISQ values

Fast & strong osseointegration with clinical results from over 10 years
Surface treatment technology that produces excellent results

XPEED surface treatment is a unique technology from MegaGen.

BLUEDIAMOND® implants undergo a special process of Ca²⁺ ion deposition on the implant surface, following S-L-A surface treatment of pure medical Grade 4 titanium. These Ca²⁺ ions create CaTiO₃ nanostructures on the implant surface that then activate osteoblasts in living bone cells.

- *In vivo*, many cations are formed on implant surface due to calcium
- More PO₄³⁻ ions are then adsorbed & Ca²⁺ ions are re-adsorbed to adsorbed PO₄³⁻ ions
- Apatite layer similar to bone mineral is promoted & mineralized into hydroxyapatite

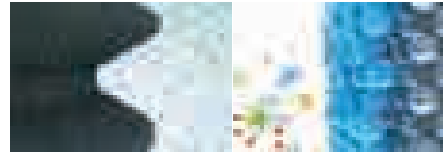

Excellent bone formation rate proven by human clinical study

Multiple animal and human clinical studies demonstrate rapid bone cell proliferation and long-term stability of Xpeed surface treatment.

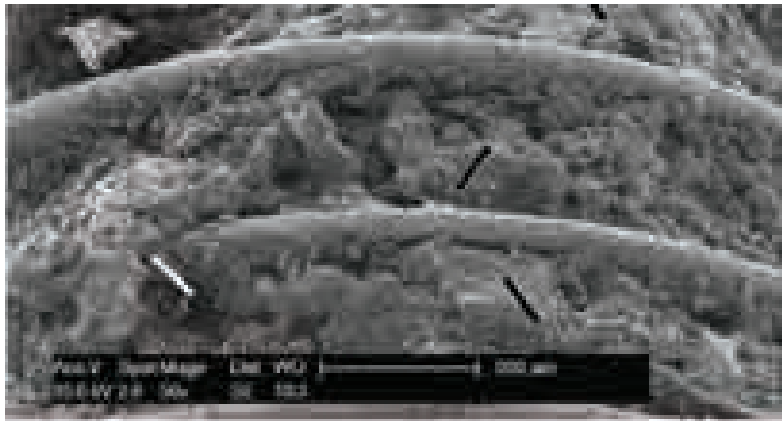

The empty spaces between the threads are completely filled with growing bone tissue (black arrow): In the early osteosynthesis process, new bone was found to cover the entire fixture, and on the left, you can see a small bone mass on the metal ridge (white arrow).

*Scanning Electron Microscope (SEM) Evaluation of Interface between Nanostructured Calcium-Incorporated Dental Implant Surface and Human Bone / Francesco Mangano / Materials (Basel). 2017 Dec; 10(12): 1438

Superiority of XPEED surface technology compared to S-L-A

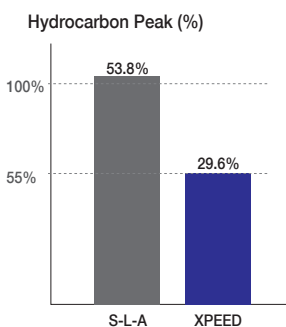

· Over 50% reduction of hydrocarbons, which interfere with osteosynthesis

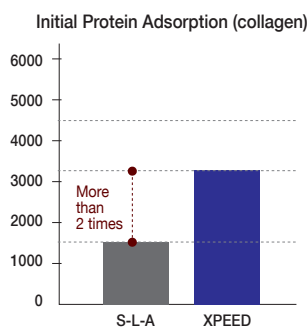

· 2 times better adsorption of essential proteins for initial osseointegration

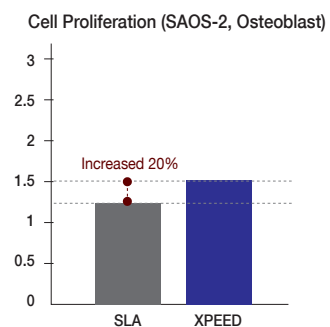

· Over 20% improved osteoblast proliferation for improved osteoblast adhesion

Superior surface technology – XPEED

Blue surface color : symbol of safety

Applied same surface treatment of AnyRidge which has awarded Clean Implant Trusted Quality Award for 5 consecutive years

- Only awarded to 11 implant brands worldwide
- Guaranteed safety of implant surface treatment & long-term implant stability

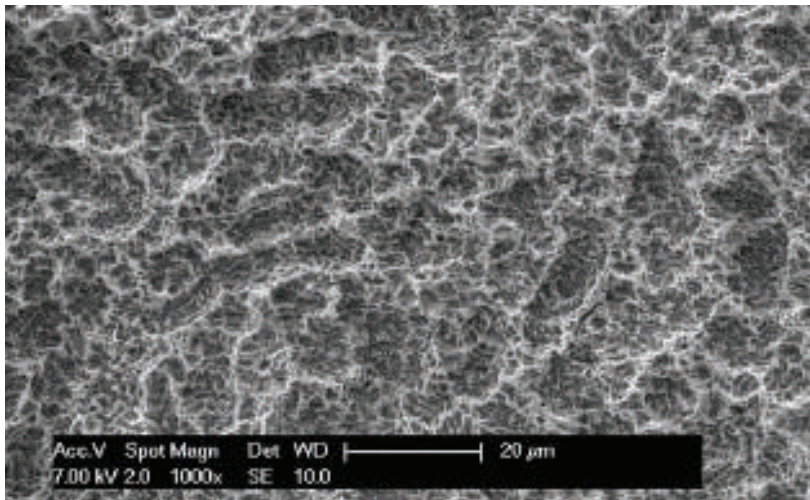

100% acid-free surface: surface treatment with NO acid residue

Self-neutralization reaction of acids & bases from XPEED® surface treatment process completely neutralizes & removes any acid residue, resulting in unique blue surface color

BLUEDIAMOND® implants have ideal roughness value (Ra 1.8-2.5μm) This regular Ra (surface roughness) value ensures more uniform bone growth

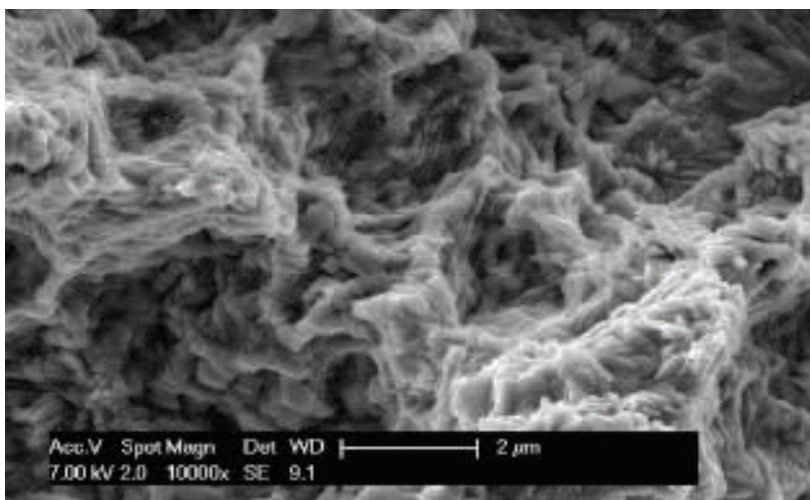

SEM shows surface is perfectly clean & no contamination



A non-profit located in Germany, the Clean Implant Foundation tests implants worldwide to ensure the quality of the surface cleanliness, and very few implant brands are certified.

Accurate positioning & excellent prosthetic connection

Feel the X-FIT™ moment! Precise Positioning & Prosthetic Connection

BLUEDIAMOND® implants have a unique X-FIT™ connection with a 30° internal conical connection & double-fastened internal structure of an arch keystone & octa combination

Devised from architectural principles, the arch-type keystone improves long-term mechanical stability with high resistance to external compressive forces, such as mastication, and an excellent stress dispersion effect.

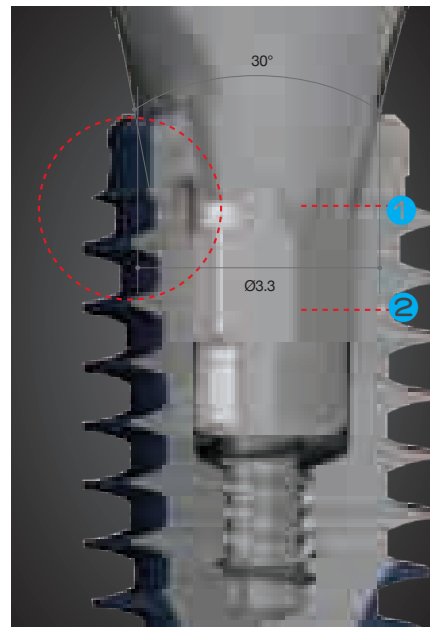

• Click! Fits in 8 positions

When correctly mounted, the abutment & fixture snap together to create a perfect connection. Plus, the position of the abutment can be precisely rotated in 45° increments (8 positions), allowing accurate positioning, especially when using an angled abutment.

• No more misconnection

BLUEDIAMOND® implants is not possible to tighten the abutment screw if the prosthesis is not correctly connected to the fixture.

A misconnected abutment screw cannot be tightened. No incorrect locking



Incorrect Phenomenon

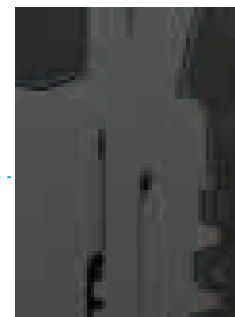
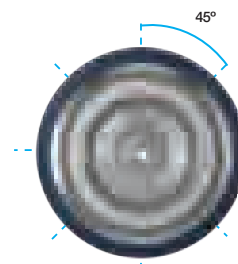

SEM Image x30

• Minimize Screw Loosening Improves convenience of implant maintenance

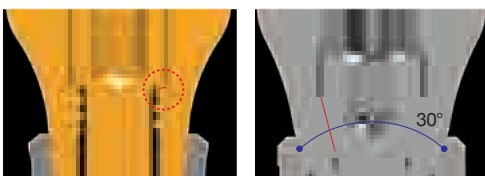

• Increased joint area between abutment screw & abutment
Minimized sinking due to 30° connection

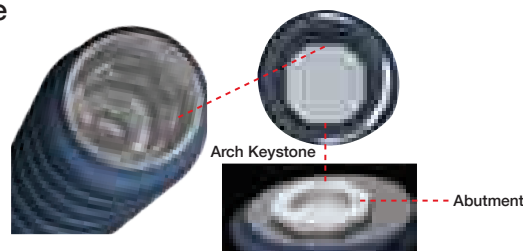

• Minimized rotation angle between abutment & fixture due to keystone structure inside fixture & abutment joint

Better esthetics & prosthetic line-up

Extensive prosthetic line-up to cover all cases & functionally superior design to guarantee improved esthetic results

Biologic S-line

Upper thread-less section of fixture & double-offset structure of biologic S-line cuff design of abutment create better peri-implant biotype & provide emergence profile for more esthetic & functional prosthetic results.

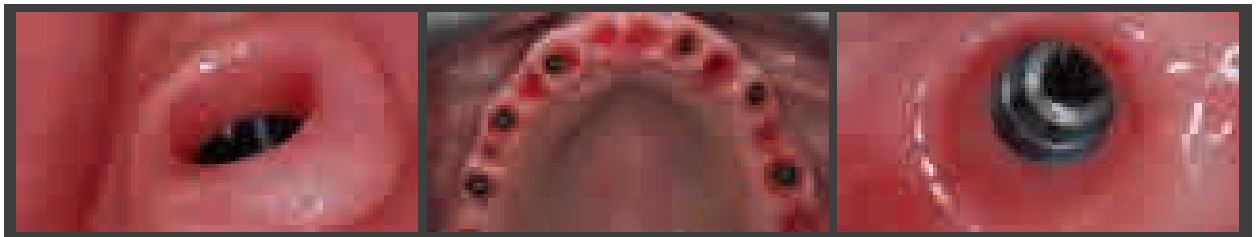
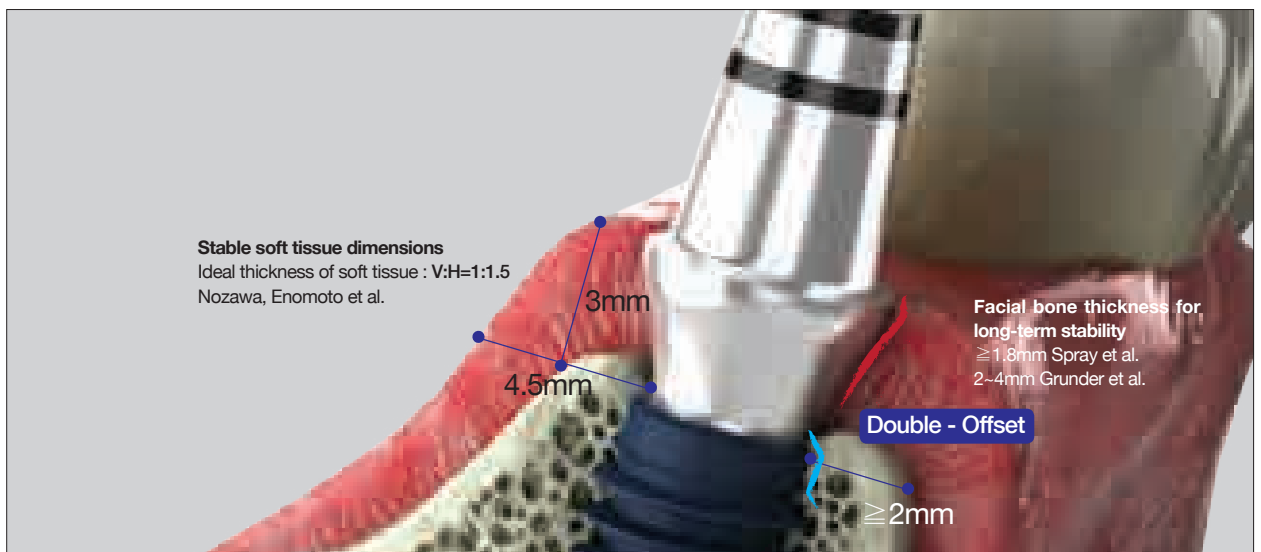

Courtesy of Dr. Edison Shimaj

The prosthetic line-up includes a variety of sizes to satisfy all clinical needs, covering overdentures, all on 4(6), digital, as well as general prosthetics.

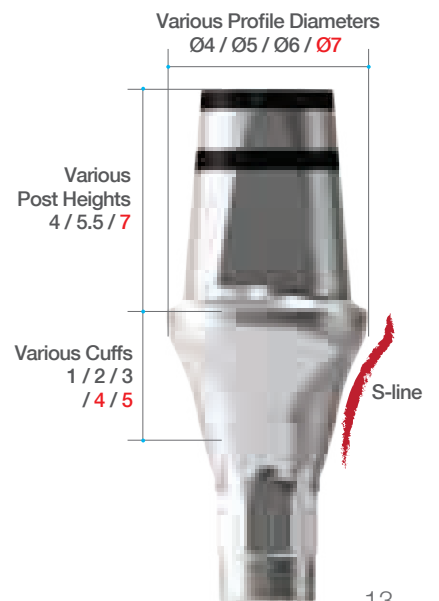
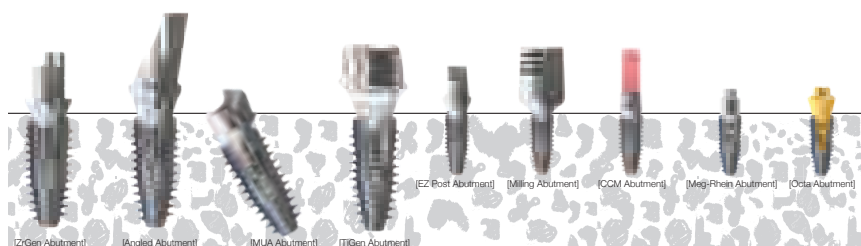

Convenient surgical kit

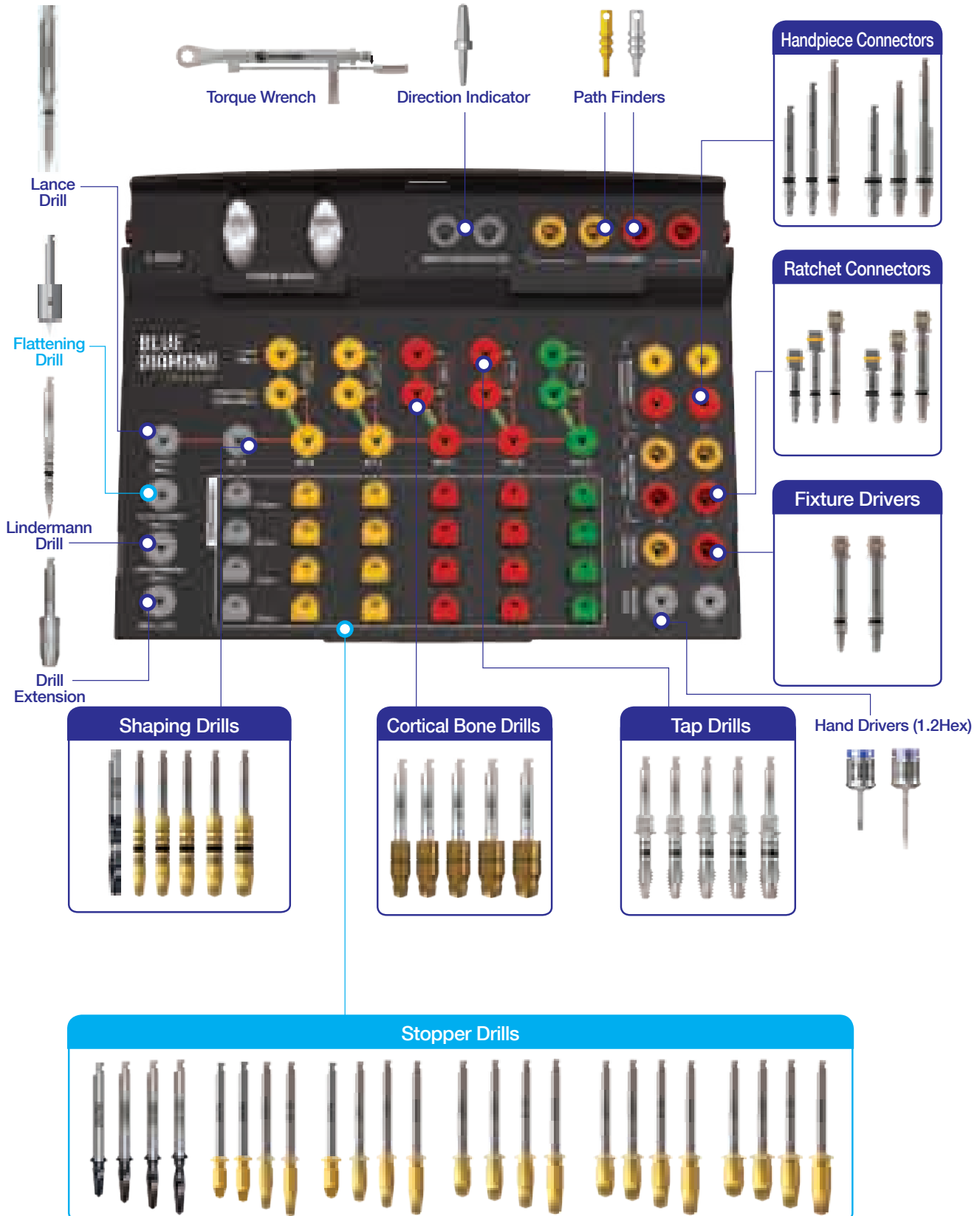

Simple & intuitive drilling sequence

Place the implant according to the guided drilling sequence for optimum initial stability

Drilling Protocol

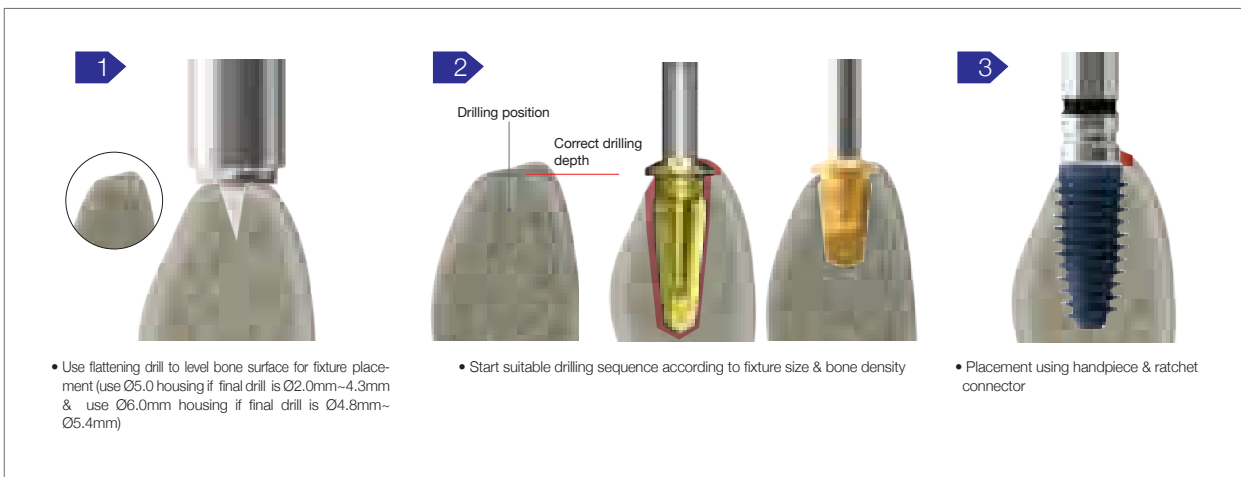

Drilling protocol according to fixture diameter & bone density for optimal initial stability

- In surgical kit, identify color line for fixture diameter to be placed
- Drill along color line according to bone density
D3: Red / D2: Yellow / D1: Green / D4 : After drilling the same sequence with D3, place deep thread fixture
- If bone density is very poor or initial stability is insufficient, place deep thread fixture of same size using same drill sequence

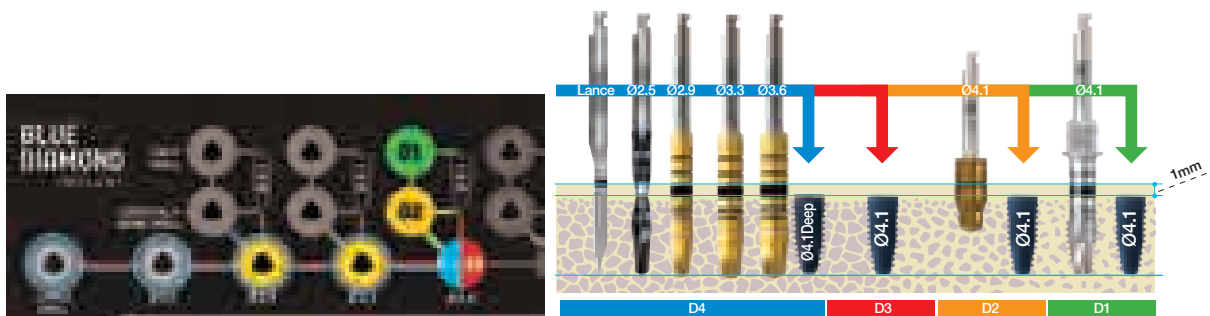

Ex) Drilling sequences when placing Ø4.1 fixture with regular thread or deep thread

BLUEDIAMOND® implants Surgical Kit Drills

	Flattening Drill	Lance	Shaping Drills						Cortical Bone Drills					Tap Drills					Stopper Drills					
	Ø5.0 / Ø2.0	Ø2.0	Ø2.5	Ø2.9	Ø3.3	Ø3.6	Ø3.9	Ø4.3	Ø3.6	Ø4.0	Ø4.4	Ø4.7	Ø5.0	Ø3.3	Ø3.7	Ø4.1	Ø4.4	Ø4.8	Ø2.5	Ø2.9	Ø3.3	Ø3.6	Ø3.9	Ø4.3
rpm max	400~600	800	800	600	600	500	500	400	300					15					800	600	600	500	500	400

Fixture Sizes & Packaging

I. Fixture Sizes

NC Ø3.3 Regular Thread

- Cover Screw included

NC			
Fixture Diameter	Connection	Length (mm)	Ref.C
Ø3.3	NC	7	ARO3307C
		8.5	ARO3308C
		10	ARO3310C
		11.5	ARO3311C
		13	ARO3313C
		15	ARO3315C
		18	ARO3318C



NC Ø3.7 Regular Thread

- Cover Screw included

NC			
Fixture Diameter	Connection	Length (mm)	Ref.C
Ø3.7	NC	7	ARO3707C
		8.5	ARO3708C
		10	ARO3710C
		11.5	ARO3711C
		13	ARO3713C
		15	ARO3715C
		18	ARO3718C



RC Ø4.1 Regular Thread

- Cover Screw included

RC			
Fixture Diameter	Connection	Length (mm)	Ref.C
Ø4.1	RC	7	ARO4107C
		8.5	ARO4108C
		10	ARO4110C
		11.5	ARO4111C
		13	ARO4113C
		15	ARO4115C
		18	ARO4118C



RC Ø4.4 Regular Thread

- Cover Screw included

RC			
Fixture Diameter	Connection	Length (mm)	Ref.C
Ø4.4	RC	7	ARO4407C
		8.5	ARO4408C
		10	ARO4410C
		11.5	ARO4411C
		13	ARO4413C
		15	ARO4415C
		18	ARO4418C



RC Ø4.8 Regular Thread

- Cover Screw included

RC			
Fixture Diameter	Connection	Length (mm)	Ref.C
Ø4.8	RC	7	ARO4807C
		8.5	ARO4808C
		10	ARO4810C
		11.5	ARO4811C
		13	ARO4813C
		15	ARO4815C
		18	ARO4818C



RC Ø5.3 Regular Thread (Coming Soon)

- Cover Screw included

Fixture Diameter	Connection	Length (mm)	Ref.C
Ø5.3	RC	7	ARO5307C
		8.5	ARO5308C
		10	ARO5310C
		11.5	ARO5311C
		13	ARO5313C
		15	ARO5315C
		18	ARO5318C



NC Ø3.3 Deep Thread

- Cover Screw included

Fixture Diameter	Connection	Length (mm)	Ref.C
Ø3.3	NC	7	ARO3307DC
		8.5	ARO3308DC
		10	ARO3310DC
		11.5	ARO3311DC
		13	ARO3313DC
		15	ARO3315DC
		18	ARO3318DC



NC Ø3.7 Deep Thread

- Cover Screw included

Fixture Diameter	Connection	Length (mm)	Ref.C
Ø3.7	NC	7	ARO3707DC
		8.5	ARO3708DC
		10	ARO3710DC
		11.5	ARO3711DC
		13	ARO3713DC
		15	ARO3715DC
		18	ARO3718DC



RC Ø4.1 Deep Thread

- Cover Screw included

Fixture Diameter	Connection	Length (mm)	Ref.C
Ø4.1	RC	7	ARO4107DC
		8.5	ARO4108DC
		10	ARO4110DC
		11.5	ARO4111DC
		13	ARO4113DC
		15	ARO4115DC
		18	ARO4118DC



RC Ø4.4 Deep Thread

- Cover Screw included

Fixture Diameter	Connection	Length (mm)	Ref.C
Ø4.4	RC	7	ARO4407DC
		8.5	ARO4408DC
		10	ARO4410DC
		11.5	ARO4411DC
		13	ARO4413DC
		15	ARO4415DC
		18	ARO4418DC



RC Ø4.8 Deep Thread

- Cover Screw included

Fixture Diameter	Connection	Length (mm)	Ref.C
Ø4.8	RC	7	ARO4807DC
		8.5	ARO4808DC
		10	ARO4810DC
		11.5	ARO4811DC
		13	ARO4813DC
		15	ARO4815DC
		18	ARO4818DC

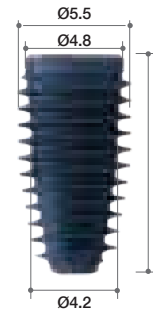

RC Ø5.3 Deep Thread (Coming Soon)

- Cover Screw included

Fixture Diameter	Connection	Length (mm)	Ref.C
Ø5.3	RC	7	ARO5307DC
		8.5	ARO5308DC
		10	ARO5310DC
		11.5	ARO5311DC
		13	ARO5313DC
		15	ARO5315DC
		18	ARO5318DC



RC Ø5.8 Deep Thread (Coming Soon)

- Cover Screw included

Fixture Diameter	Connection	Length (mm)	Ref.C
Ø5.8	RC	7	ARO5807DC
		8.5	ARO5808DC
		10	ARO5810DC
		11.5	ARO5811DC
		13	ARO5813DC
		15	ARO5815DC
		18	ARO5818DC



RC Ø6.3 Deep Thread (Coming Soon)

- Cover Screw included

Fixture Diameter	Connection	Length (mm)	Ref.C
Ø6.3	RC	7	ARO6307DC
		8.5	ARO6308DC
		10	ARO6310DC
		11.5	ARO6311DC
		13	ARO6313DC
		15	ARO6315DC
		18	ARO6318DC



II. Packaging

- Ampule

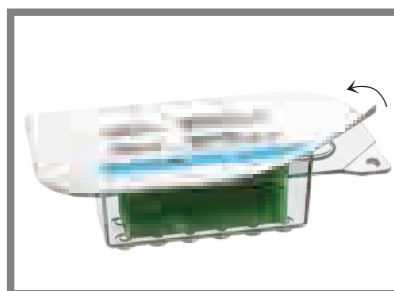

Peel off cover & remove ampule

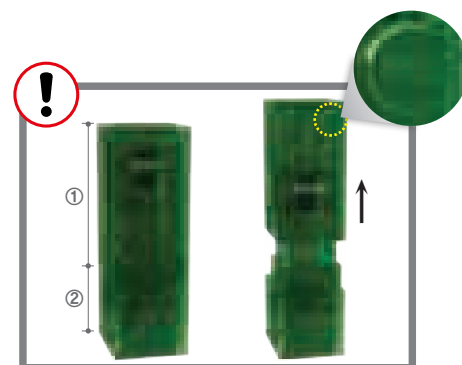

Separate top^① & bottom^②, as shown, to reveal inner ampule with fixture

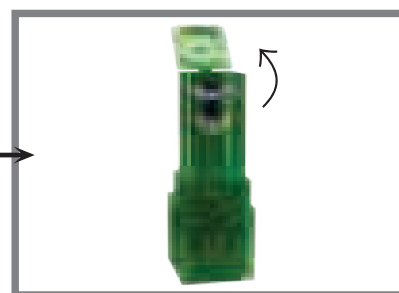

Flip open top to reveal fixture



Connect handpiece to fixture



Make sure fixture is fully connected, then remove from ampule



Place fixture according to drilling sequence

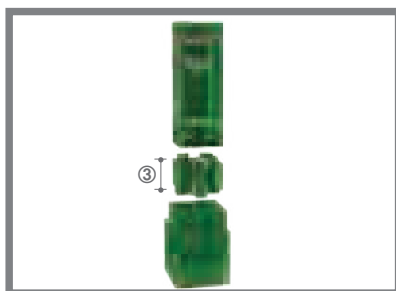

Separate fixture ampule from bottom, as shown, to reveal cover screw holder[®]

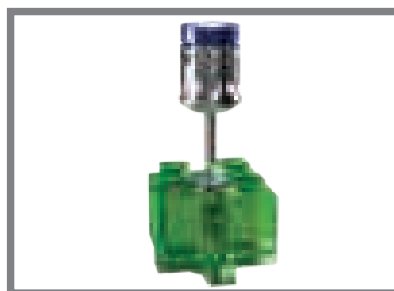

Use hand driver to pick up cover screw

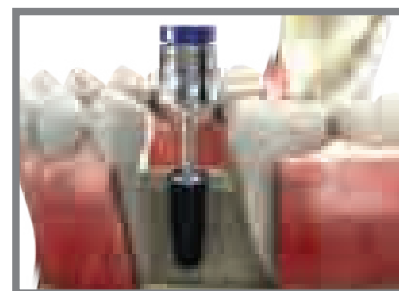

Tighten cover screw to fixture

MegaGen ampule is re-usable as building block (after cleaning & sterilization) reducing plastic waste!

Cover Screws & Healing Abutments

Cover Screw

- Cover screw (AROCSN3005 / AROCSR3705) included

- For use with submerged-type surgery
- Protects inner structure of fixture
- Different height options
- 1mm & umbrella (wide dia.) cover screw can be purchased separately
- Recommended torque: by hand (5 - 8Ncm)
- Use with Hand Driver(1.2 Hex)



NC

Diameter	Height (mm)	Ref.C
Ø3.0	0.5	AROCSN3005
Ø3.0	1.0	*AROCSN3010
Ø5.0	0.5	*AROCSN5005

(*) Separate sales item



RC

Diameter	Height (mm)	Ref.C
Ø3.7	0.5	AROCSR3705
Ø3.7	1.0	*AROCSR3710
Ø6.0	0.5	*AROCSR6005

(*) Separate sales item

Umbrella Cover Screw



Prevents implant from falling into maxillary sinus
Suitable for simple GBR surgery



Use with Hand Driver

Healing Abutment

- For use with non-submerged-type surgery & 2-stage surgery
- Different diameter & height options
- Helps to form suitable emergence profile during gingival healing
- Recommended torque: by hand (5 - 8Ncm)
- Use with Hand Driver (1.2 Hex)

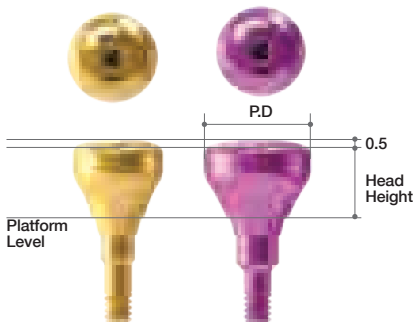

NC

Profile Diameter	Height (mm)	Ref.C
Ø3.0	2	AROHAN302
	3	AROHAN303
	4	AROHAN304
	5	AROHAN305
	6	AROHAN306
	7	AROHAN307
	8	AROHAN308
	9	AROHAN309
	Ø4.0	2
3		AROHAN403
4		AROHAN404
5		AROHAN405
6		AROHAN406
7		AROHAN407
8		AROHAN408
9		AROHAN409
Ø5.0		2
	3	AROHAN503
	4	AROHAN504
	5	AROHAN505
	6	AROHAN506
	7	AROHAN507
	8	AROHAN508
	9	AROHAN509

RC

Profile Diameter	Height (mm)	Ref.C
Ø4.0	2	AROHAR402
	3	AROHAR403
	4	AROHAR404
	5	AROHAR405
	6	AROHAR406
	7	AROHAR407
	8	AROHAR408
	9	AROHAR409
	Ø5.0	2
3		AROHAR503
4		AROHAR504
5		AROHAR505
6		AROHAR506
7		AROHAR507
8		AROHAR508
9		AROHAR509
Ø6.0		2
	3	AROHAR603
	4	AROHAR604
	5	AROHAR605
	6	AROHAR606
	7	AROHAR607
	8	AROHAR608
	9	AROHAR609
	Ø7.0	2
3		AROHAR703
4		AROHAR704
5		AROHAR705
6		AROHAR706
7		AROHAR707
8		AROHAR708
9		AROHAR709

Healing Abutment

(Anatomic type)

- Abutment screw (H=4 AROHAS1604/ H=5 AROHAS1605/ H=7 AROHAS1607) included

- For use with non-submerged type surgery & 2-stage surgery
- Different diameter & height options
- Helps to form suitable emergence profile during gingival healing
- Recommend torque: by hand (5 - 8Ncm)
- Use with Hand Driver(1.2 Hex)

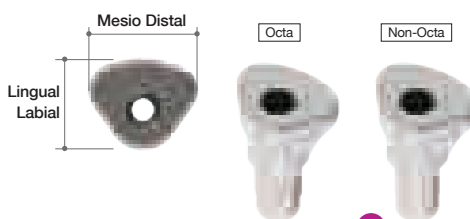

NC

Type	MD (mm)	LL (mm)	Height (mm)	Connection	Ref.C	
Incisor	4.0	5.0	4	Octa	AROHIN40504T	
			5		AROHIN40505T	
			7		AROHIN40507T	
	4.5	4.5	4		AROHIN45454T	
			5		AROHIN45455T	
			7		AROHIN45457T	
	6.0	5.0	4		AROHIN60504T	
			5		AROHIN60505T	
			7		AROHIN60507T	
	7.0	6.0	4	AROHIN70604T		
			5	AROHIN70605T		
			7	AROHIN70607T		
	Incisor	4.0	5.0	4	Non-Octa	AROHIN40504NT
				5		AROHIN40505NT
				7		AROHIN40507NT
		4.5	4.5	4		AROHIN45454NT
				5		AROHIN45455NT
				7		AROHIN45457NT
6.0		5.0	4	AROHIN60504NT		
			5	AROHIN60505NT		
			7	AROHIN60507NT		
7.0		6.0	4	AROHIN70604NT		
			5	AROHIN70605NT		
			7	AROHIN70607NT		

RC

Type	MD (mm)	LL (mm)	Height (mm)	Connection	Ref.C	
Incisor	4.0	5.0	4	Octa	AROHIR40504	
			5		AROHIR40505	
			7		AROHIR40507	
	4.5	4.5	4		AROHIR45454	
			5		AROHIR45455	
			7		AROHIR45457	
	6.0	5.0	4		AROHIR60504	
			5		AROHIR60505	
			7		AROHIR60507	
	7.0	6.0	4	AROHIR70604		
			5	AROHIR70605		
			7	AROHIR70607		
	Incisor	4.0	5.0	4	Non-Octa	AROHIR40504N
				5		AROHIR40505N
				7		AROHIR40507N
		4.5	4.5	4		AROHIR45454N
				5		AROHIR45455N
				7		AROHIR45457N
6.0		5.0	4	AROHIR60504N		
			5	AROHIR60505N		
			7	AROHIR60507N		
7.0		6.0	4	AROHIR70604N		
			5	AROHIR70605N		
			7	AROHIR70607N		

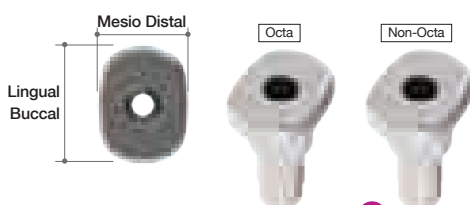

NC

Type	MD (mm)	LB (mm)	Height (mm)	Connection	Ref.C
Canine	5.0	5.5	4	Octa	AROHCN50654T
			5		AROHCN50655T
			7		AROHCN50657T
	5.0	5.5	4	Non-Octa	AROHCN50654NT
			5		AROHCN50655NT
			7		AROHCN50657NT

RC

Type	MD (mm)	LB (mm)	Height (mm)	Connection	Ref.C
Canine	5.0	5.5	4	Octa	AROHC50654T
			5		AROHC50655T
			7		AROHC50657T
	5.0	5.5	4	Non-Octa	AROHC50654NT
			5		AROHC50655NT
			7		AROHC50657NT

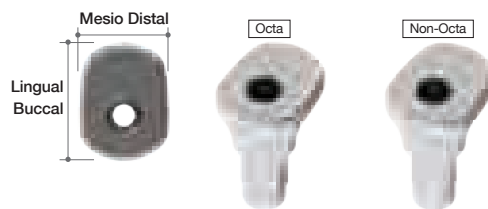
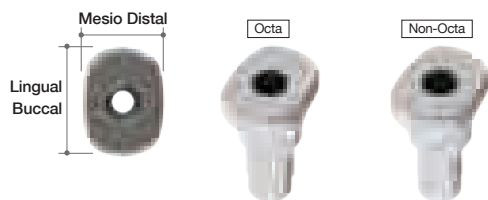

Type	MD (mm)	LB (mm)	Height (mm)	Connection	Ref.C
Pre-Molar	4.5	6.0	4	Octa	AROHMR45604T
			5		AROHMR45605T
			7		AROHMR45607T
			4		AROHMR50704T
			5		AROHMR50705T
			7		AROHMR50707T
	4.5	6.0	4	Non-Octa	AROHMR45604NT
			5		AROHMR45605NT
			7		AROHMR45607NT
			4		AROHMR50704NT
			5		AROHMR50705NT
			7		AROHMR50707NT

Type	MD (mm)	LB (mm)	Height (mm)	Connection	Ref.C		
Special	4.5	6.0	4	Octa	AROHSR45604T		
			5		AROHSR45605T		
			7		AROHSR45607T		
			4		AROHSR50654T		
			5.0		6.5	5	AROHSR50655T
						7	AROHSR50657T
	4	AROHSR50704T					
	5.0	7.0	5		AROHSR50705T		
			7		AROHSR50707T		
			4		AROHSR60704T		
	6.0	7.0	5		AROHSR60705T		
			7		AROHSR60707T		
			4		AROHSR60804T		
	6.0	8.0	5		AROHSR60805T		
			7		AROHSR60807T		
			4		AROHSR60904T		
	6.0	9.0	5		AROHSR60905T		
			7		AROHSR60907T		
			4		AROHSR70804T		
	7.0	8.0	5		AROHSR70805T		
			7		AROHSR70807T		
			4		AROHSR70904T		
	7.0	9.0	5		AROHSR70905T		
			7		AROHSR70907T		
			4		AROHSR70104T		
	7.0	10.0	5		AROHSR70105T		
			7		AROHSR70107T		
			4		AROHSR80904T		
	8.0	9.0	5		AROHSR80905T		
			7		AROHSR80907T		
			4		AROHSR80104T		
	8.0	10.0	5		AROHSR80105T		
			7		AROHSR80107T		
			4		AROHSR80107T		
	Non-Octa	4.5	6.0		4	AROHMR60704T	
					5	AROHMR60705T	
					7	AROHMR60707T	
					4	AROHMR60804T	
					5	AROHMR60805T	
					7	AROHMR60807T	
		6.0	8.0		4	AROHMR60904T	
					5	AROHMR60905T	
7				AROHMR60907T			
7.0		8.0	4	AROHMR70804T			
			5	AROHMR70805T			
			7	AROHMR70807T			
7.0		9.0	4	AROHMR70904T			
			5	AROHMR70905T			
			7	AROHMR70907T			
7.0		10.0	4	AROHMR70104T			
			5	AROHMR70105T			
			7	AROHMR70107T			
8.0		9.0	4	AROHMR80904T			
			5	AROHMR80905T			
			7	AROHMR80907T			
8.0		10.0	4	AROHMR80104T			
			5	AROHMR80105T			
			7	AROHMR80107T			
6.0	7.0	4	AROHMR60704NT				
		5	AROHMR60705NT				
		7	AROHMR60707NT				
		4	AROHMR60804NT				
		5	AROHMR60805NT				
		7	AROHMR60807NT				
	6.0	8.0	4	AROHMR60904NT			
			5	AROHMR60905NT			
			7	AROHMR60907NT			
	7.0	8.0	4	AROHMR70804NT			
			5	AROHMR70805NT			
			7	AROHMR70807NT			
7.0	9.0	4	AROHMR70904NT				
		5	AROHMR70905NT				
		7	AROHMR70907NT				
7.0	10.0	4	AROHMR70104NT				
		5	AROHMR70105NT				
		7	AROHMR70107NT				
8.0	9.0	4	AROHMR80904NT				
		5	AROHMR80905NT				
		7	AROHMR80907NT				
8.0	10.0	4	AROHMR80104NT				
		5	AROHMR80105NT				
		7	AROHMR80107NT				

Abutment & Prosthetic Options

I. Fixture-level Prosthesis

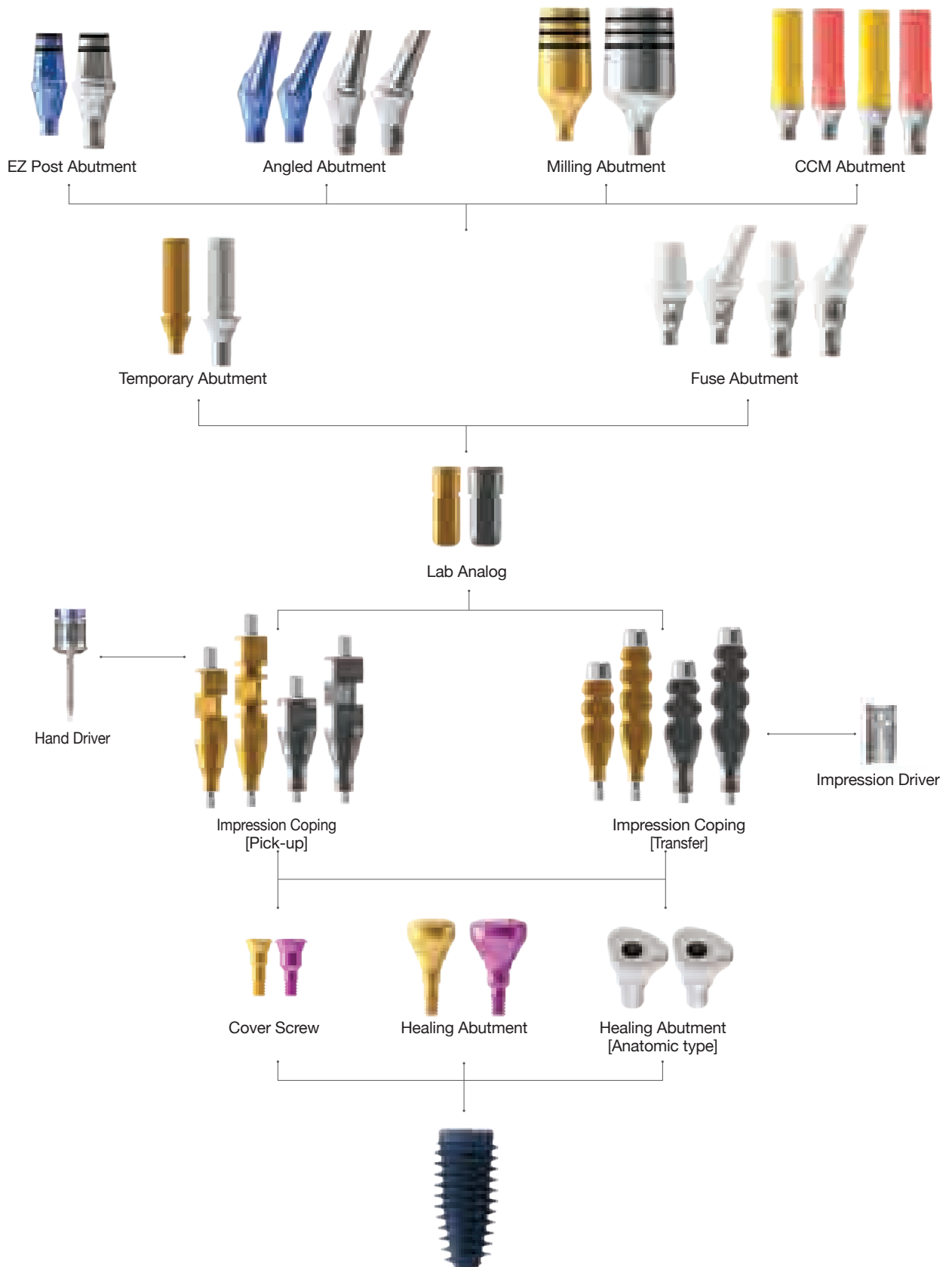

➔ Impression Copings & Lab Analog

Impression Coping

(2-piece, transfer type for Closed-tray technique)

- Guide pin (AROGPT12/ 16) included

- For use with Closed-tray technique
- Design ensures easy & accurate transfer of fixture position
- Flat surface of impression coping aligns with flat Octa surface within fixture
- Use Transfer Driver & Hand Driver (1.2Hex) to ensure impression coping is properly tightened

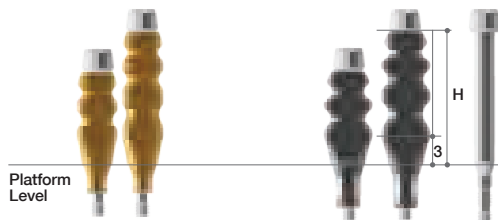

NC

Profile Diameter	Height (mm)	Ref.C
Ø4.0	12	AROICTN4012T
	16	AROICTN4016T

RC

Profile Diameter	Height (mm)	Ref.C
Ø5.0	12	AROICTR5012T
	16	AROICTR5016T

Impression Coping

(2-piece, pick-up type for Open-tray technique)

- Guide pin (AROGPP10/ 15/ 20) included

- For use with Open-tray technique
- Most beneficial for multiple fixtures that will be splinted together
- Tray angle body design ensures stability within impression & accurate transfer of fixture position
- Extra-long guide pin can be purchased separately (AROGPP25)

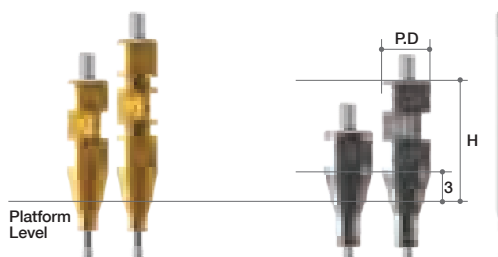

NC

Profile Diameter	Height (mm)	Ref.C
Ø4.0	12	AROICPN4012T
	16	AROICPN4016T

RC

Profile Diameter	Height (mm)	Ref.C
Ø5.0	7	AROICPR5007T
	12	AROICPR5012T

Lab Analog

- For use to replicate fixture
- Gold analog for NC connection fixture
- Silver analog for RC connection fixture



NC

Profile Diameter	Ref.C
Ø3.3	AROLAN

RC

Profile Diameter	Ref.C
Ø4.1	AROLAR

➔ Temporary Abutments

Temporary Abutment (Titanium)

- Abutment screw (AROAS16B/ AROAS16) included

- For use when making provisional restoration
- Octa & Non-Octa options
- Grooved surface on abutment post allows better retention of resin or wax
- Recommended torque: 25Ncm

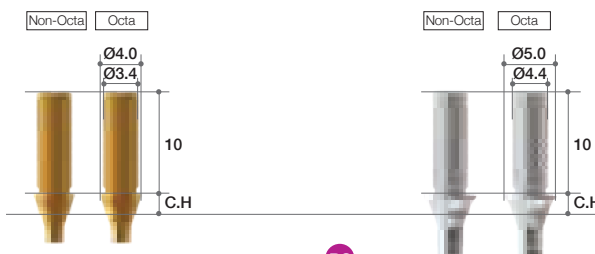

NC

Profile Diameter	C.H (mm)	Type	Ref.C
Ø3.0	2	Octa	AROTANO3210T
		Non-Octa	AROTANN3210T
	3	Octa	AROTANO3310T
		Non-Octa	AROTANN3310T
Ø4.0	2	Octa	AROTANO4210T
		Non-Octa	AROTANN4210T
	3	Octa	AROTANO4310T
		Non-Octa	AROTANN4310T

RC

Profile Diameter	C.H (mm)	Type	Ref.C
Ø4.5	2	Octa	AROTARO4210T
		Non-Octa	AROTARN4210T
3	3	Octa	AROTARO4310T
		Non-Octa	AROTARN4310T
Ø5.0	2	Octa	AROTARO5210T
		Non-Octa	AROTARN5210T
	3	Octa	AROTARO5310T
		Non-Octa	AROTARN5310T

Fuse Abutment

- Abutment screw (AROAS16B/ AROAS16) & fuse cap included

- Recommended torque: 25Ncm



NC

Diameter Labio-lingual	Diameter Mesio-distal	C.H (mm)	P.H (mm)	Type	Ref.C
Ø5.5	Ø5.5	4	5.5	Straight	AROFAN5545T
	Ø4.5		7	15°	AROFAN5415T
			7	25°	AROFAN5425T

RC

Diameter Labio-lingual	Diameter Mesio-distal	C.H (mm)	P.H (mm)	Type	Ref.C
Ø5.5	Ø5.5	4	5.5	Straight	AROFAR5545T
	Ø4.5		7	15°	AROFAR5415T
			7	25°	AROFAR5425T

Rationale for Fuse Abutment™

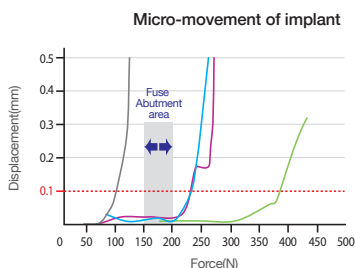

Compressive strength test to evaluate micro movement of bone density
-R&D Center, MegaGen Implant Co., Ltd.(2012)-

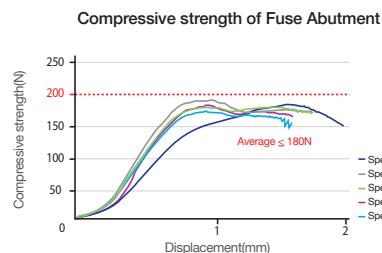

Compressive strength test to evaluate yield strength of Fuse Abutment
-R&D Center, MegaGen Implant Co., Ltd.(2012)-

➔ Abutment Options

EZ Post Abutment

- Abutment screw (AROAS16B/ AROAS16) included

- For use with cement-retained restoration
- Post Heights: 4.0/ 5.5/ 7mm
- Profile Diameters: Ø4/ Ø5/ Ø6/ Ø7
- Cuff Heights: 1/ 2/ 3/ 4/ 5mm
- Biological S-line provides seamless natural-looking & more functional emergence profile
- Laser markings at 4 & 5.5mm from platform level
- Color-coded for different profile diameters
- Recommended torque: 35Ncm

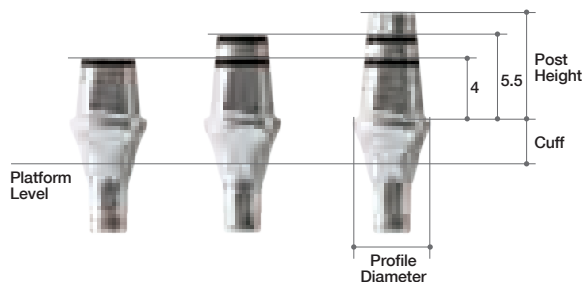

Profile Diameter	Cuff Height(mm)	Post Height(mm)	Ref.C
Ø4.0	1	4.0	AROEPN4014T
	2		AROEPN4024T
	3		AROEPN4034T
	4		AROEPN4044T
	5		AROEPN4054T
	1	5.5	AROEPN4015T
	2		AROEPN4025T
	3		AROEPN4035T
	4		AROEPN4045T
	5		AROEPN4055T
	1	7.0	AROEPN4017T
	2		AROEPN4027T
	3		AROEPN4037T
	4		AROEPN4047T
	5		AROEPN4057T



Profile Diameter	Cuff Height(mm)	Post Height(mm)	Ref.C
Ø5.0	1	4.0	AROEPN5014T
	2		AROEPN5024T
	3		AROEPN5034T
	4		AROEPN5044T
	5		AROEPN5054T
	1	5.5	AROEPN5015T
	2		AROEPN5025T
	3		AROEPN5035T
	4		AROEPN5045T
	5		AROEPN5055T
	1	7.0	AROEPN5017T
	2		AROEPN5027T
	3		AROEPN5037T
	4		AROEPN5047T
	5		AROEPN5057T



RC

Profile Diameter	Cuff Height(mm)	Post Height(mm)	Ref.C
Ø5.0	1	4.0	AROEP5014T
	2		AROEP5024T
	3		AROEP5034T
	4		AROEP5044T
	5		AROEP5054T
	1	5.5	AROEP5015T
	2		AROEP5025T
	3		AROEP5035T
	4		AROEP5045T
	5		AROEP5055T
	1	7.0	AROEP5017T
	2		AROEP5027T
	3		AROEP5037T
	4		AROEP5047T
	5		AROEP5057T



RC

Profile Diameter	Cuff Height(mm)	Post Height(mm)	Ref.C
Ø6.0	1	4.0	AROEP6014T
	2		AROEP6024T
	3		AROEP6034T
	4		AROEP6044T
	5		AROEP6054T
	1	5.5	AROEP6015T
	2		AROEP6025T
	3		AROEP6035T
	4		AROEP6045T
	5		AROEP6055T
	1	7.0	AROEP6017T
	2		AROEP6027T
	3		AROEP6037T
	4		AROEP6047T
	5		AROEP6057T



RC

Profile Diameter	Cuff Height(mm)	Post Height(mm)	Ref.C
Ø7.0	1	4.0	AROEP7014T
	2		AROEP7024T
	3		AROEP7034T
	4		AROEP7044T
	5		AROEP7054T
	1	5.5	AROEP7015T
	2		AROEP7025T
	3		AROEP7035T
	4		AROEP7045T
	5		AROEP7055T
	1	7.0	AROEP7017T
	2		AROEP7027T
	3		AROEP7037T
	4		AROEP7047T
	5		AROEP7057T

➔ Abutment Options

Angled Abutment

- Abutment screw (AROAS16B/ AROAS16) included

- Angulations: 15°, 25°
- Profile diameters: Ø4.0, 5.0, 6.0, 7.0
- Cuff heights: 1, 2, 3, 4, 5mm
- 16 directions covered: 8 to surface(Octa), 8 to Octa edge
- Color-coded by diameter for better identification
- Minimized screw head length & height to prevent milling problems
- Recommended torque: 35Ncm

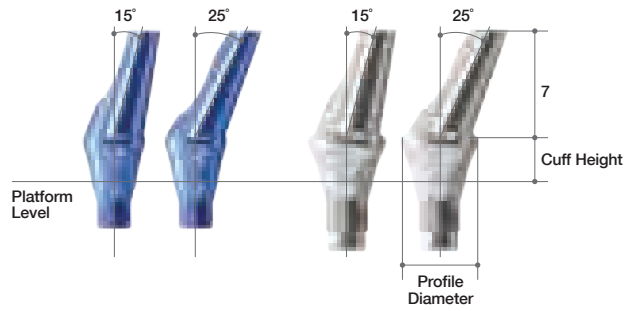



NC

Profile Diameter	Cuff Height(mm)	Type	Angle	Ref.C
Ø4.0	1	Octa	15°	AR0AAON4115T
	2			AR0AAON4215T
	3			AR0AAON4315T
	4			AR0AAON4415T
	5			AR0AAON4515T
	1	Edge		AR0AAEN4115T
	2			AR0AAEN4215T
	3			AR0AAEN4315T
	4			AR0AAEN4415T
	5			AR0AAEN4515T



NC

Profile Diameter	Cuff Height(mm)	Type	Angle	Ref.C
Ø4.0	1	Octa	25°	AR0AAON4125T
	2			AR0AAON4225T
	3			AR0AAON4325T
	4			AR0AAON4425T
	5			AR0AAON4525T
	1	Edge		AR0AAEN4125T
	2			AR0AAEN4225T
	3			AR0AAEN4325T
	4			AR0AAEN4425T
	5			AR0AAEN4525T



NC

Profile Diameter	Cuff Height(mm)	Type	Angle	Ref.C
Ø5.0	1	Octa	15°	AR0AAON5115T
	2			AR0AAON5215T
	3			AR0AAON5315T
	4			AR0AAON5415T
	5			AR0AAON5515T
	1	Edge		AR0AAEN5115T
	2			AR0AAEN5215T
	3			AR0AAEN5315T
	4			AR0AAEN5415T
	5			AR0AAEN5515T



NC

Profile Diameter	Cuff Height(mm)	Type	Angle	Ref.C
Ø5.0	1	Octa	25°	AR0AAON5125T
	2			AR0AAON5225T
	3			AR0AAON5325T
	4			AR0AAON5425T
	5			AR0AAON5525T
	1	Edge		AR0AAEN5125T
	2			AR0AAEN5225T
	3			AR0AAEN5325T
	4			AR0AAEN5425T
	5			AR0AAEN5525T



RC

Profile Diameter	Cuff Height(mm)	Type	Angle	Ref.C
Ø5.0	1	Octa	15°	AR0AAOR5115T
	2			AR0AAOR5215T
	3			AR0AAOR5315T
	4			AR0AAOR5415T
	5			AR0AAOR5515T
	1	Edge		AR0AAER5115T
	2			AR0AAER5215T
	3			AR0AAER5315T
	4			AR0AAER5415T
	5			AR0AAER5515T



RC

Profile Diameter	Cuff Height(mm)	Type	Angle	Ref.C
Ø5.0	1	Octa	25°	AR0AAOR5125T
	2			AR0AAOR5225T
	3			AR0AAOR5325T
	4			AR0AAOR5425T
	5			AR0AAOR5525T
	1	Edge		AR0AAER5125T
	2			AR0AAER5225T
	3			AR0AAER5325T
	4			AR0AAER5425T
	5			AR0AAER5525T



RC

Profile Diameter	Cuff Height(mm)	Type	Angle	Ref.C
Ø6.0	1	Octa	15°	AR0AAOR6115T
	2			AR0AAOR6215T
	3			AR0AAOR6315T
	4			AR0AAOR6415T
	5			AR0AAOR6515T
	1	Edge		AR0AAER6115T
	2			AR0AAER6215T
	3			AR0AAER6315T
	4			AR0AAER6415T
	5			AR0AAER6515T



RC

Profile Diameter	Cuff Height(mm)	Type	Angle	Ref.C
Ø6.0	1	Octa	25°	AR0AAOR6125T
	2			AR0AAOR6225T
	3			AR0AAOR6325T
	4			AR0AAOR6425T
	5			AR0AAOR6525T
	1	Edge		AR0AAER6125T
	2			AR0AAER6225T
	3			AR0AAER6325T
	4			AR0AAER6425T
	5			AR0AAER6525T



RC

Profile Diameter	Cuff Height(mm)	Type	Angle	Ref.C
Ø7.0	1	Octa	15°	AR0AAOR7115T
	2			AR0AAOR7215T
	3			AR0AAOR7315T
	4			AR0AAOR7415T
	5			AR0AAOR7515T
	1	Edge		AR0AAER7115T
	2			AR0AAER7215T
	3			AR0AAER7315T
	4			AR0AAER7415T
	5			AR0AAER7515T



RC

Profile Diameter	Cuff Height(mm)	Type	Angle	Ref.C
Ø7.0	1	Octa	25°	AR0AAOR7125T
	2			AR0AAOR7225T
	3			AR0AAOR7325T
	4			AR0AAOR7425T
	5			AR0AAOR7525T
	1	Edge		AR0AAER7125T
	2			AR0AAER7225T
	3			AR0AAER7325T
	4			AR0AAER7425T
	5			AR0AAER7525T

➔ Abutment Options

Milling Abutment

- Abutment screw (AROAS16B/ AROAS16) included
- Long post enables easier customization for milling
- Recommended torque: 35Ncm

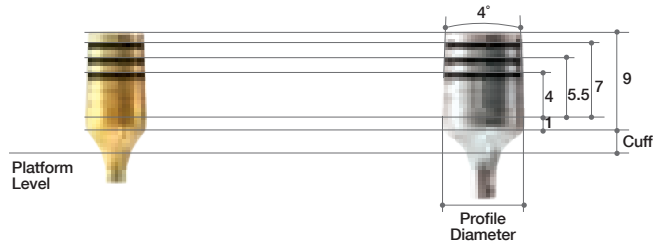

NC

Profile Diameter	Cuff Height (mm)	Post Height (mm)	Ref.C
Ø6.0	1	9	AROMAN6019T
	2		AROMAN6029T
	3		AROMAN6039T
	4		AROMAN6049T
	5		AROMAN6059T

RC

Profile Diameter	Cuff Height (mm)	Post Height (mm)	Ref.C
Ø8.0	1	9	AROMAR8019T
	2		AROMAR8029T
	3		AROMAR8039T
	4		AROMAR8049T
	5		AROMAR8059T

CCM Abutment

- Abutment screw (AROAS16B/ AROAS16) included
- For use with difficult customized abutment
- Can be cast with non-precious alloys(Ni-Cr, Cr-Co alloys)
- Non-precious melting temperature: depends on manufacturer
- Threaded sleeves for convenient resin / wax-up
- CMM melting temperature: 1300~1400°C
- Recommended torque: 35Ncm

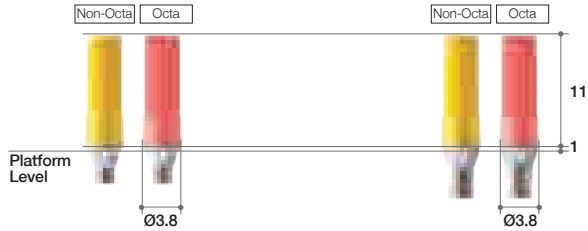

NC

Profile Diameter	Cuff Height (mm)	Post Height (mm)	Ref.C
Ø3.8	1	11	AROCCMNO4111T
			AROCCMNN4111T

RC

Profile Diameter	Cuff Height (mm)	Post Height (mm)	Ref.C
Ø3.8	1	11	AROCCMRO4111T
			AROCCMRN4111T

II. Abutment-level Prosthesis

1. EZ Post Abutment & Components

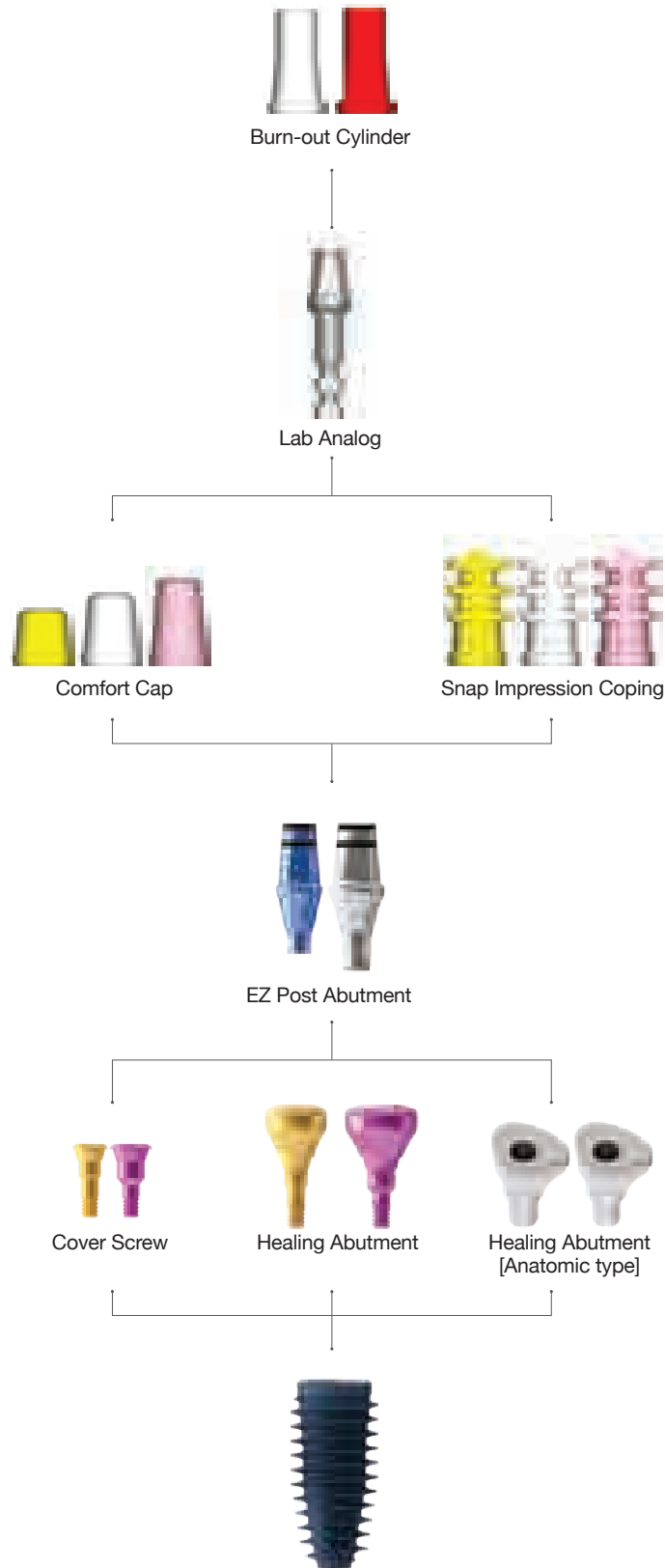

➔ Components for Solid Abutments

Snap Impression Coping

- For use with impression taking of solid abutments
- Color-coded according to post height
- Profile diameters: Ø4, 5, 6, 7
- Do not use when abutment is trimmed

Profile Diameter	Ref.C
Ø4.0	AANSIF440
	AANSIF455
	AANSIF470
Ø5.0	AANSIF540
	AANSIF555
	AANSIF570
Ø6.0	AANSIF640
	AANSIF655
	AANSIF670
Ø7.0	AANSIF740
	AANSIF755
	AANSIF770

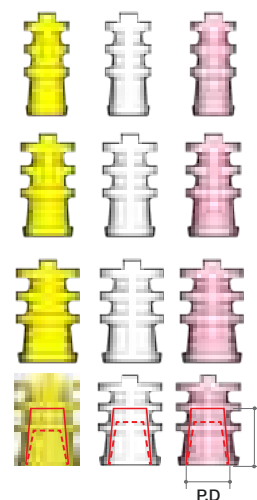

Comfort Cap

- Protects solid abutment & minimizes irritation to tongue & oral mucosa
- Can be applied under temporary prosthetics
- Color-coded according to post height

Profile Diameter	Post Height(mm)	Ref.C
Ø4.0	4	AANCCF440
	5.5	AANCCF455
	7	AANCCF470
Ø5.0	4	AANCCF540
	5.5	AANCCF555
	7	AANCCF570
Ø6.0	4	AANCCF640
	5.5	AANCCF655
	7	AANCCF670
Ø7.0	4	AANCCF740
	5.5	AANCCF755
	7	AANCCF770

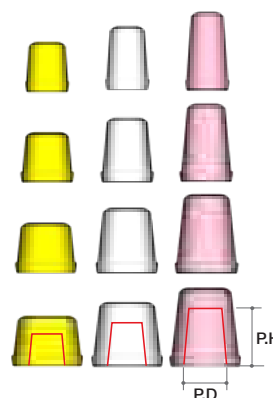

Lab Analog

- Directly connects to Snap Impression Coping in impression to make stone model

Profile Diameter	Height(mm)	Ref.C
Ø4.0	4	AANSLF440
	5.5	AANSLF455
	7	AANSLF470
Ø5.0	4	AANSLF540
	5.5	AANSLF555
	7	AANSLF570
Ø6.0	4	AANSLF640
	5.5	AANSLF655
	7	AANSLF670
Ø7.0	4	AANSLF740
	5.5	AANSLF755
	7	AANSLF770

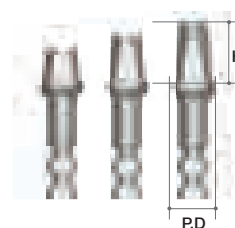

Burn-out Cylinder

- Fits with Lab Analog(solid level)
- Easy for wax-up & accurate casting
- Use white cylinder for multiple units
- Use red cylinder for single crown

Profile Diameter	Type	Ref.C
Ø4.0	Multiple	AANBCB470
Ø5.0		AANBCB570
Ø6.0		AANBCB670
Ø7.0		AANBCB770
Ø4.0	Single	AANBCS470
Ø5.0		AANBCS570
Ø6.0		AANBCS670
Ø7.0		AANBCS770

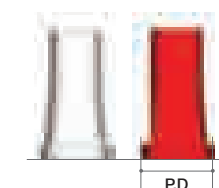

II. Abutment Level Prosthesis

2. Octa Abutment & Components

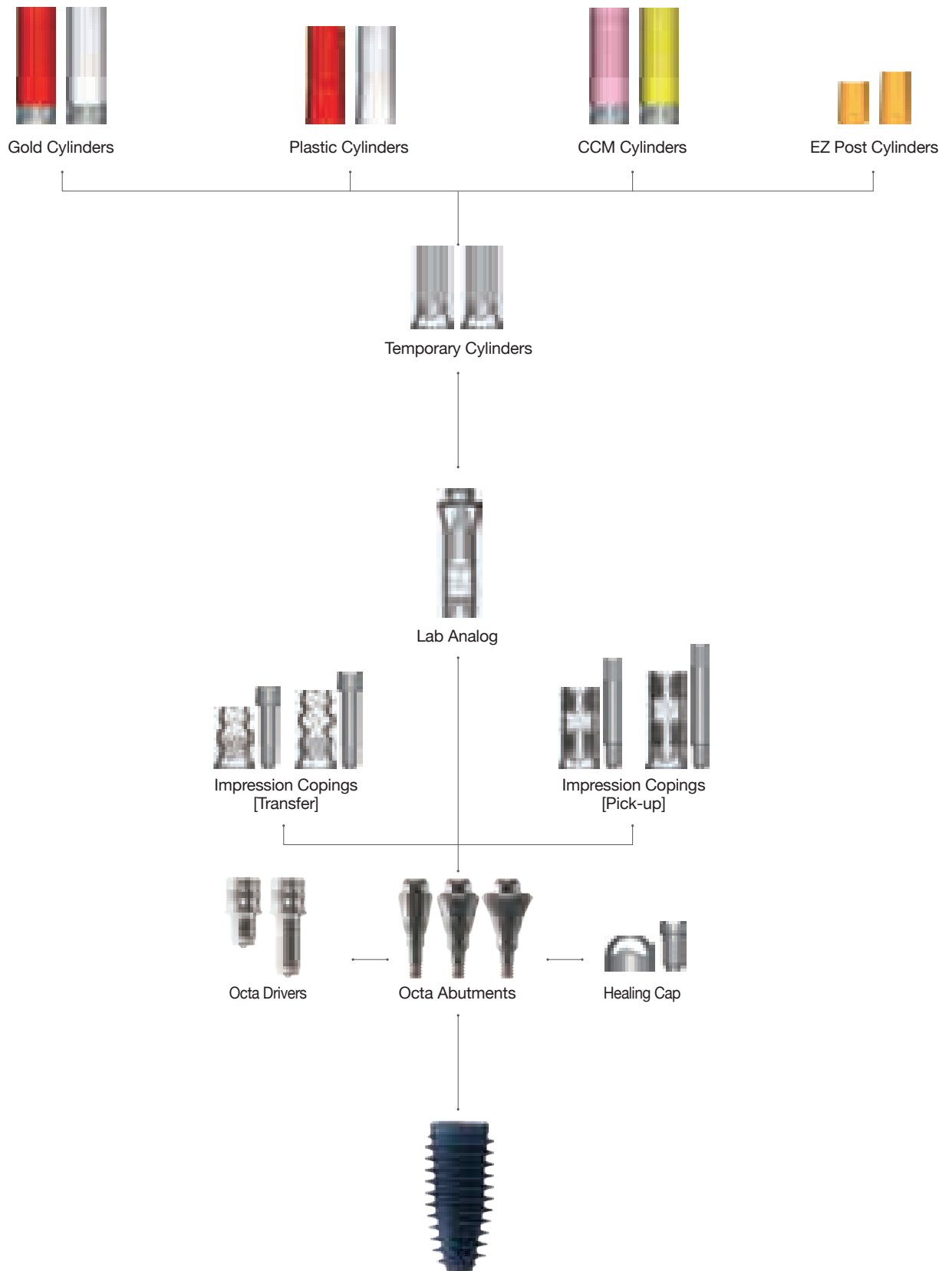

➔ Components for Octa Abutment

Octa Abutment

- For use with multiple screw-retained prosthetics
- Use with Octa Driver
- Recommended torque: 35Ncm

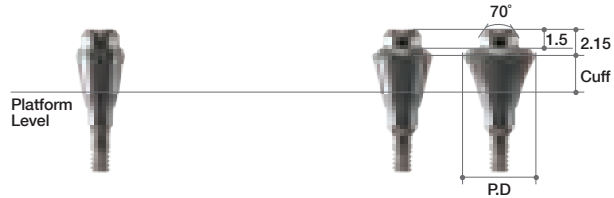

NC

Profile Diameter	Cuff Height (mm)	Ref.C
Ø4.0	1	AROAN4010
	2	AROAN4020
	3	AROAN4030
	4	AROAN4040
	5	AROAN4050

RC

Profile Diameter	Cuff Height (mm)	Ref.C
Ø5.0	1	AROAR5010
	2	AROAR5020
	3	AROAR5030
	4	AROAR5040
	5	AROAR5050
Ø6.0	1	AROAR6010
	2	AROAR6020
	3	AROAR6030
	4	AROAR6040
	5	AROAR6050

Healing Cap

- Cylinder screw (IRCS200) included
- Protects Octa Abutment & minimizes irritation to tongue & oral mucosa

Profile Diameter	Ref.C
Ø4.0	AANOHC4000T
Ø5.0	IHC400T
Ø6.0	AANOHC6000T



Impression Coping (Transfer)

- Guide pin (AAOTGP10 / AAOTGP12) included
- Tightened using Impression Driver or 1.2 Hex Driver
- Special impression coping screw for use with 1.2mm hex driver available on request

Profile Diameter	Height (mm)	Type	Ref.C
Ø4.0	7.5	Octa	AAOITO4010T
		Non-Octa	AAOITN4010T
	9.5	Octa	AAOITO4012T
		Non-Octa	AAOITN4012T
Ø5.0	7.5	Octa	AAOITO5010T
		Non-Octa	AAOITN5010T
	9.5	Octa	AAOITO5012T
		Non-Octa	AAOITN5012T
Ø6.0	7.5	Octa	AAOITO6010T
		Non-Octa	AAOITN6010T
	9.5	Octa	AAOITO6012T
		Non-Octa	AAOITN6012T

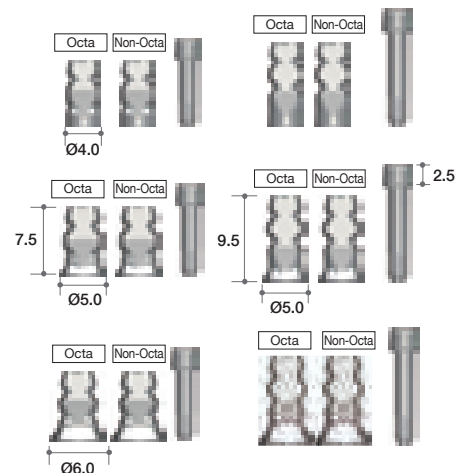

➔ Components for Octa Abutment

Impression Coping (Pick-up)

- Guide pin (AAOPGP10 / AAOPGP12) included

Profile Diameter	Height (mm)	Type	Ref.C
Ø4.0	10.0	Octa	AAOIPO4010T
		Non-Octa	AAOIPN4010T
	12.0	Octa	AAOIPO4012T
		Non-Octa	AAOIPN4012T
Ø5.0	10.0	Octa	AAOIPO5010T
		Non-Octa	AAOIPN5010T
	12.0	Octa	AAOIPO5012T
		Non-Octa	AAOIPN5012T
Ø6.0	10.0	Octa	AAOIPO6010T
		Non-Octa	AAOIPN6010T
	12.0	Octa	AAOIPO6012T
		Non-Octa	AAOIPN6012T

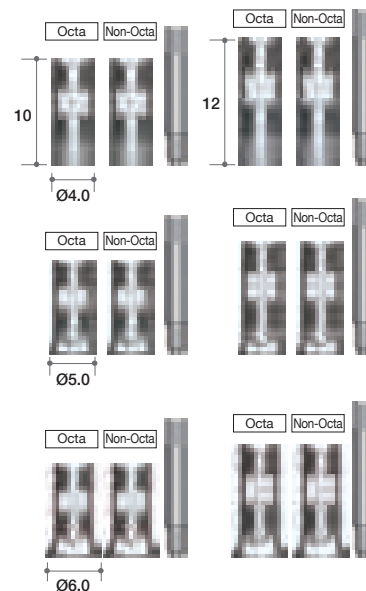

Lab Analog

Profile Diameter	Ref.C
Ø3.8	AANOLA4000
Ø4.8	IOA300
Ø5.8	AANOLA6000

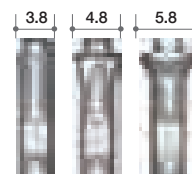

Temporary Cylinder

- Cylinders screw (IRCS200) included

• Recommended torque: 25Ncm

Profile Diameter	Type	Ref.C
Ø4.0	Octa	AANOTCO4010T
	Non-Octa	AANOTCN4010T
Ø5.0	Octa	AANOTCO5010T
	Non-Octa	AANOTCN5010T
Ø6.0	Octa	AANOTCO6010T
	Non-Octa	AANOTCN6010T

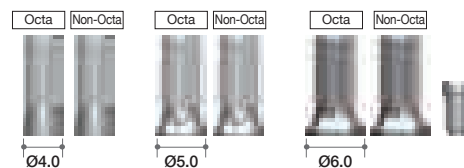

EZ Post Cylinder

- Cylinder screw (IRCS200) included

• Recommended torque: 35Ncm

Profile Diameter	Post Height(mm)	Type	Ref.C
Ø4.0	5.5	Octa	AAOECO4005T
		Non-Octa	AAOECN4005T
	7.0	Octa	AAOECO4007T
		Non-Octa	AAOECN4007T
Ø5.0	5.5	Octa	AAOECO5005T
		Non-Octa	AAOECN5005T
	7.0	Octa	AAOECO5007T
		Non-Octa	AAOECN5007T
Ø6.0	5.5	Octa	AAOECO6005T
		Non-Octa	AAOECN6005T
	7.0	Octa	AAOECO6007T
		Non-Octa	AAOECN6007T

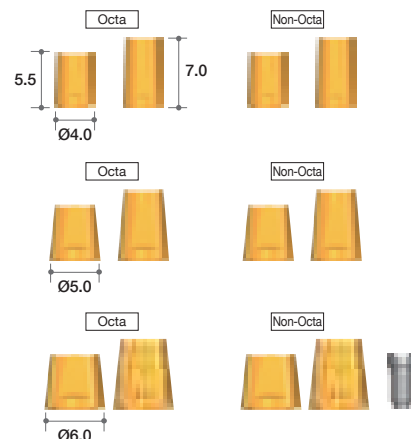

Gold Cylinder

- Cylinder screw (IRCS200) included

- For use with customizing abutment for screw-retained multi-unit restoration
- Octa(red) & Non-Octa(white) options
- Diameters: Ø4.0, 5.0, 6.0
- Threaded sleeves for better retention of resin or wax
- Melting point of gold alloy: 1063°C
- Recommended torque: 30Ncm

Profile Diameter	Type	Ref.C
Ø4.0	Octa	AANGCO4000T
	Non-Octa	AANGCN4000T
Ø5.0	Octa	IOGO100T
	Non-Octa	IONGN100T
Ø6.0	Octa	AANGCO6000T
	Non-Octa	AANGCN6000T

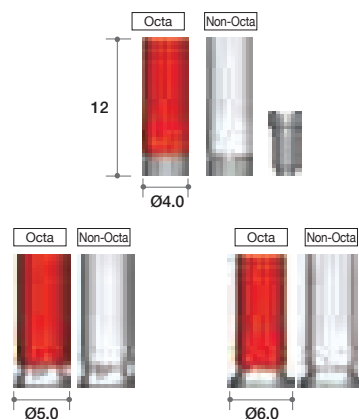

CCM Cylinder

- Cylinder screw (IRCS200) included

- Octa (pink) & Non-Octa (yellow) options
- Diameters: Ø4.0, 5.0, 6.0
- Threaded sleeves for better retention of resin or wax
- Melting temperature of CCM base: 1300~1400°C
- Can be cast using non-precious alloys (Ni-Cr, Cr-Co alloys)
- Recommended torque: 35Ncm

Profile Diameter	Type	Ref.C
Ø4.0	Octa	AANCCO4000T
	Non-Octa	AANCCN4000T
Ø5.0	Octa	AANCCO5000T
	Non-Octa	AANCCN5000T
Ø6.0	Octa	AANCCO6000T
	Non-Octa	AANCCN6000T

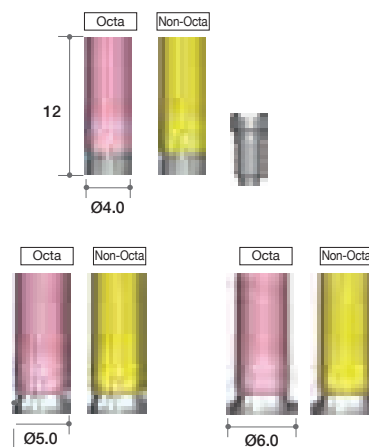

Plastic Cylinder

- Cylinder screw(IRCS200) included

- Economical option
- For use with customizing abutment for screw-retained multi-unit restoration
- Octa (red) & Non-Octa (white) options
- Threaded sleeves for better retention of resin or wax
- Recommended torque: 25Ncm

Profile Diameter	Type	Ref.C
Ø4.0	Octa	AAOTCO4010T
	Non-Octa	AAOTCN4010T
Ø5.0	Octa	IOPH100T
	Non-Octa	IOPN100T
Ø6.0	Octa	AAOTCO6010T
	Non-Octa	AAOTCN6010T

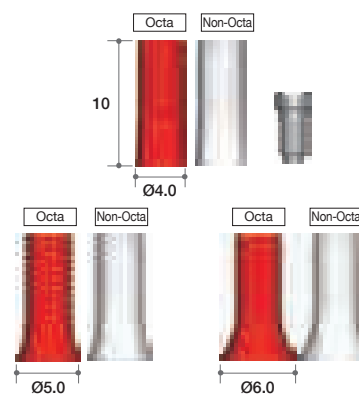

II. Abutment-level Prosthesis

3. Multi-unit Abutment & Components

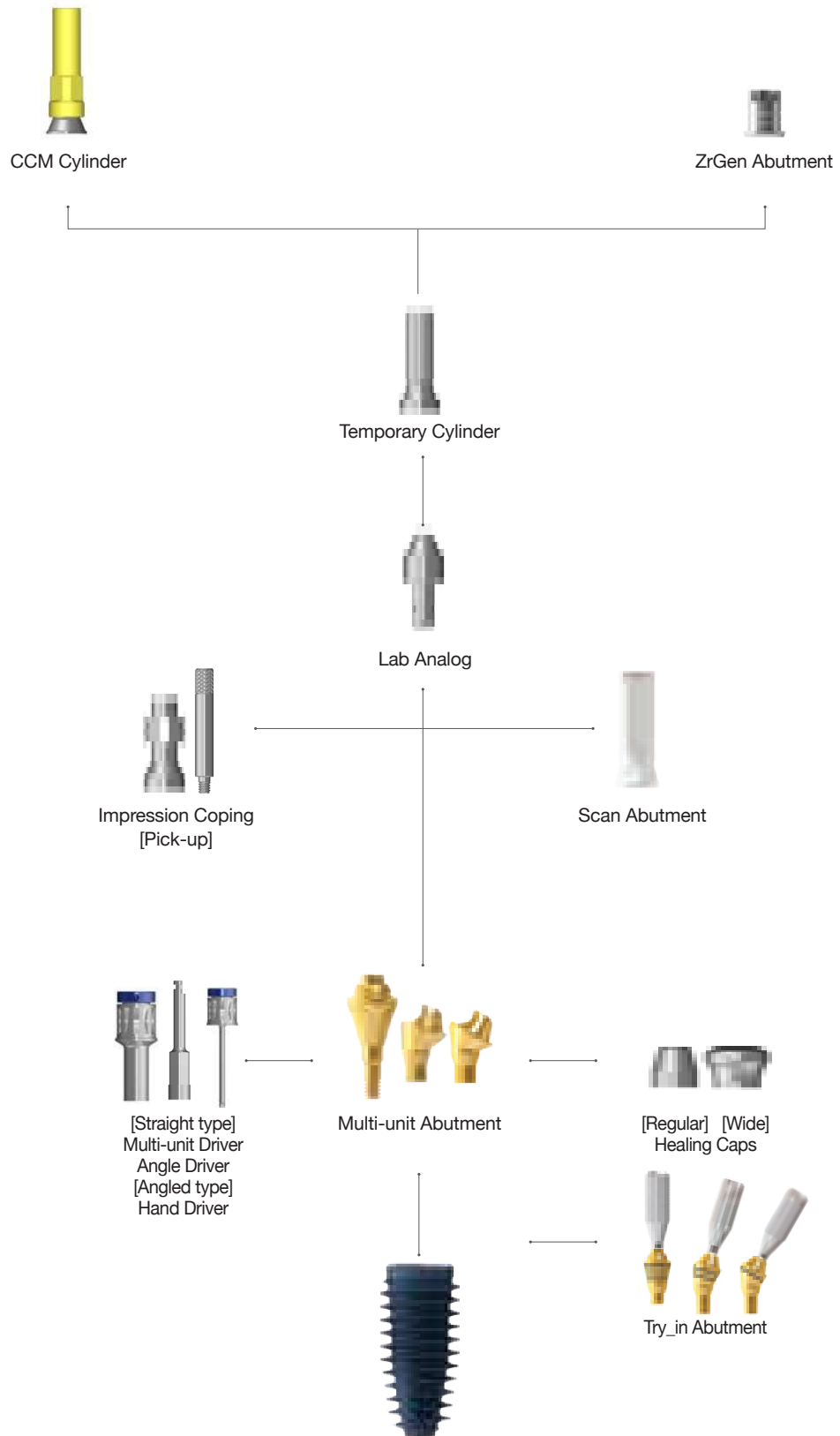

►► Multi-unit Abutments™

Design Concept

Intended as a solution for edentulous patients, multi-unit abutments work best with an All-on-4 procedure: 2 x straight-type abutments in anterior positions, plus 2 x angled-type (multi-unit) abutments in posterior positions.

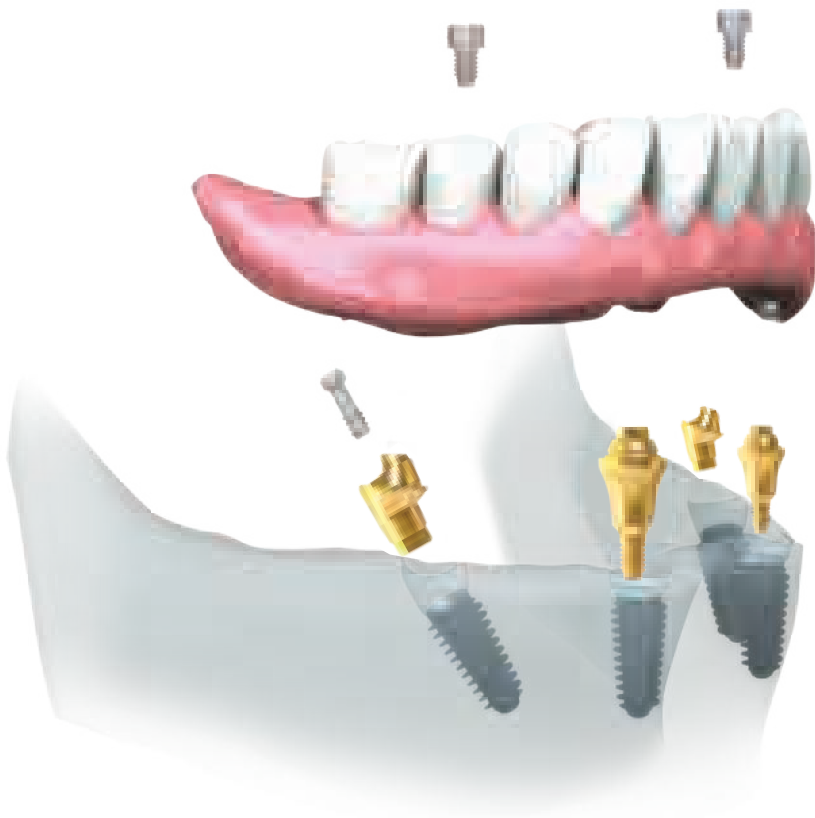

Features & Benefits

- Minimal number of fixtures & angled placement allows full use of existing bone & can avoid GBR procedures
- Angulation of fixtures avoids sensitive areas, such as mandibular nerve & maxillary sinus
- Angulated fixtures in posterior positions become osseointegrated with cancellous bone & disperse vertical load on alveolar bone
- Guided surgical option for All-on-4 technique is also possible using R2GATE software

►► Multi-unit Abutment N Type

Solution for edentulous patients

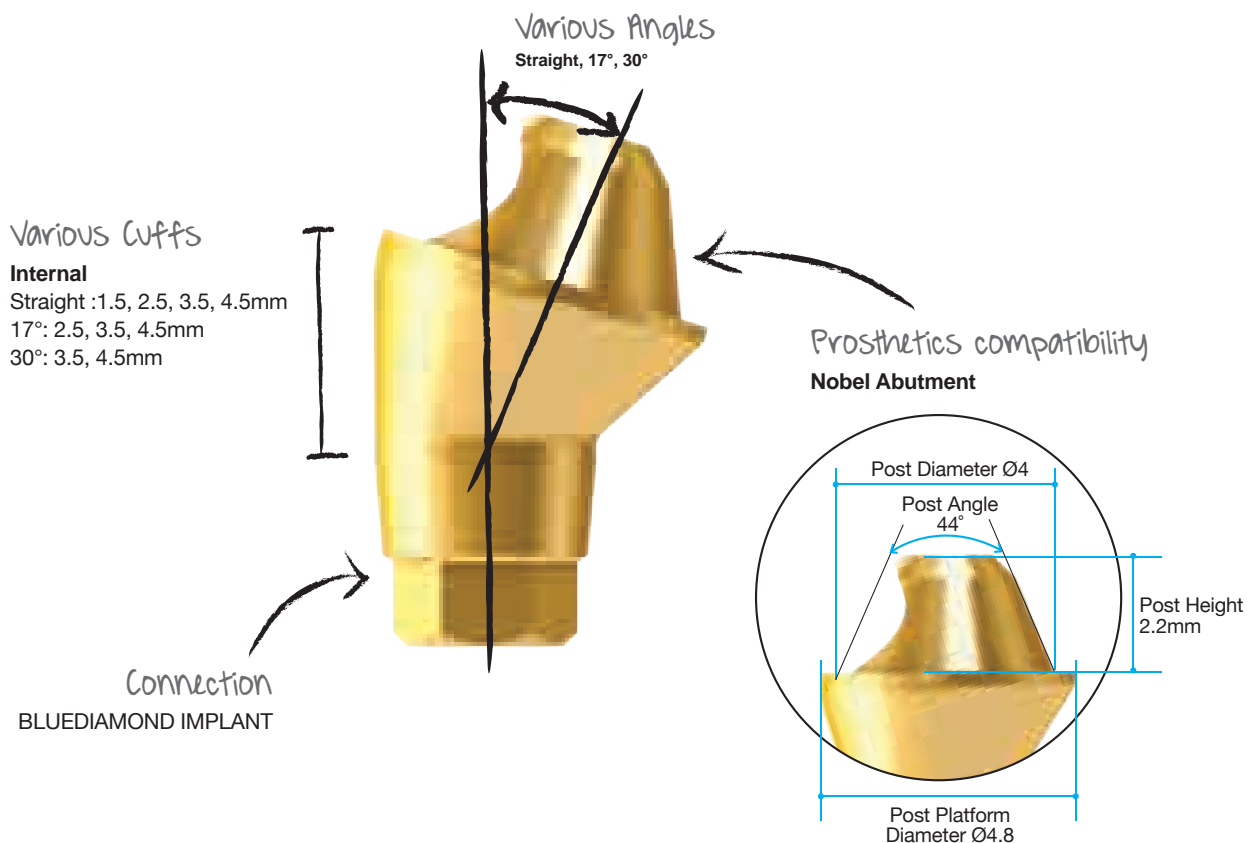

Benefits

1. Easy & economical treatment solution for compromised edentulous cases
2. Can avoid expensive & time consuming bone graft procedures
3. Multiple angles (0°, 17°, 30°) to support different placement paths
4. Universally compatible with other multi-unit systems

Compatibility with other multi-unit level prosthetic components

- ✓ Post Height
- ✓ Post Diameter
- ✓ Post Angle
- ✓ Abutment Angle
- ✓ Cuff Height

➔ Multi-unit Abutments

Straight Multi-unit Abutment

- MUA Straight Carrier (MUASC) included
- Recommended torque: 35Ncm

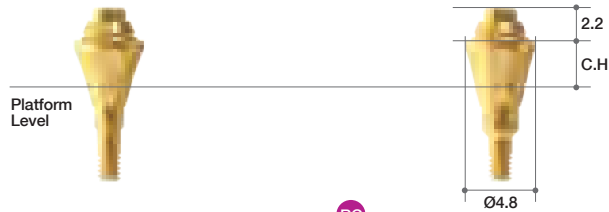

NC

Cuff Height (mm)	Type	Ref.C
1.5	1-piece (M1.6)	MUAARONN0015C
2.5		MUAARONN0025C
3.5		MUAARONN0035C
4.5		MUAARONN0045C

RC

Cuff Height (mm)	Type	Ref.C
1.5	1-piece (M1.6)	MUAARORN0015C
2.5		MUAARORN0025C
3.5		MUAARORN0035C
4.5		MUAARORN0045C

17° Multi-unit Angled Abutment

- MUA screw (MUAAROS) included
- MUA Angled Carrier (MUAAC) included
- Recommended torque: 25Ncm

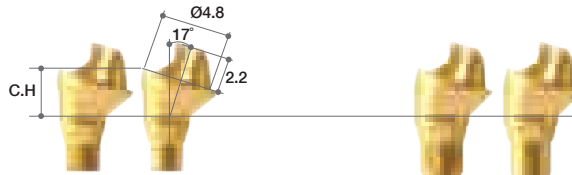

NC

Cuff Height (mm)	Type	Ref.C
2.5	Octa	MUAARONO1725TC
3.5		MUAARONO1735TC
4.5		MUAARONO1745TC
2.5	Non-Octa	MUAARONN1725TC
3.5		MUAARONN1735TC
4.5		MUAARONN1745TC

RC

Cuff Height (mm)	Type	Ref.C
2.5	Octa	MUAARORO1725TC
3.5		MUAARORO1735TC
4.5		MUAARORO1745TC
2.5	Non-Octa	MUAARORN1725TC
3.5		MUAARORN1735TC
4.5		MUAARORN1745TC

30° Multi-unit Angled Abutment

- MUA screw (MUAAROS) included
- MUA Angled Carrier (MUAAC) included
- Recommended torque: 25Ncm

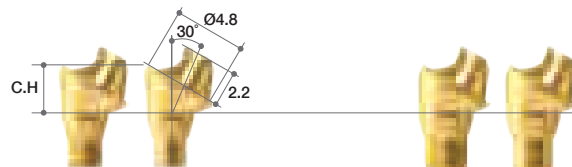

NC

Cuff Height (mm)	Type	Ref.C
3.5	Octa	MUAARONO3035TC
4.5		MUAARONO3045TC
3.5	Non-Octa	MUAARONN3035TC
4.5		MUAARONN3045TC

RC

Cuff Height (mm)	Type	Ref.C
3.5	Octa	MUAARORO3035TC
4.5		MUAARORO3045TC
3.5	Non-Octa	MUAARORN3035TC
4.5		MUAARORN3045TC

►► Contents of Multi-unit Abutment Set

Multi-unit Abutment Healing cap-type Set reference code

Order code: Add "HP" after existing reference code

E.g.) MUAARONO3035TC → MUAARONO3035 HP

Multi-unit Abutment CCM-type Set reference code

Order code: Add "P" after existing reference code

E.g.) MUAARONO3035TC → MUAARONO3035 P

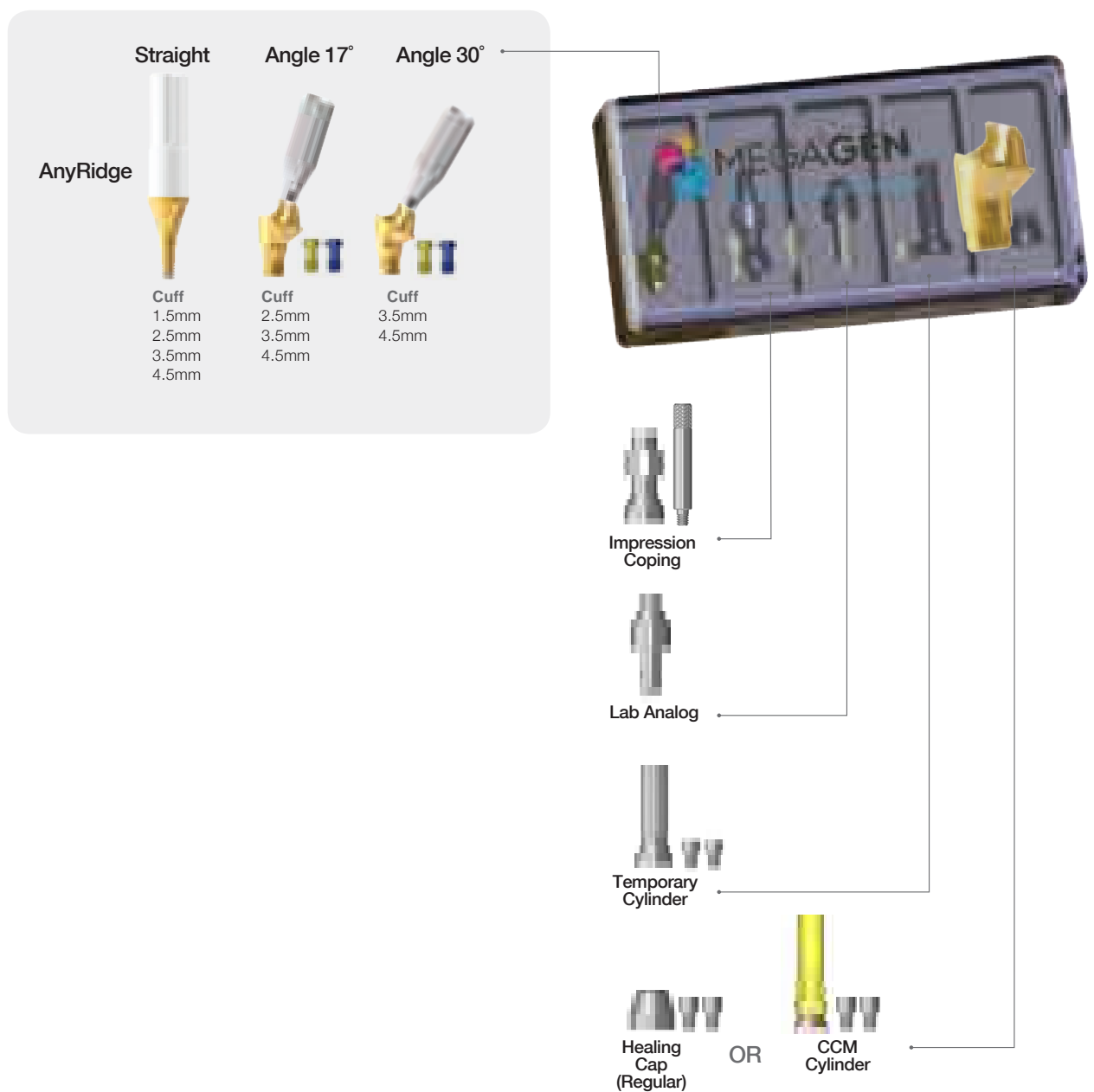

➔ Components for Multi-unit Abutment

Impression coping (Pick-up)

- Guide pin (MUAGP) included
- For use with impression taking at abutment level
- Open-tray method

Connection	Ref.C
Non-Hex	MUAICT

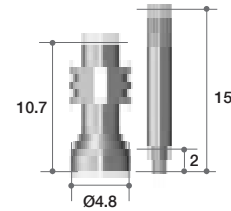

Lab Analog

- For use with duplicating multi-unit abutment in working model
- Available as RP Analog for 3D-printed working model

Head form	Ref.C
Multi-unit Abutment(Nobel)	MUALA

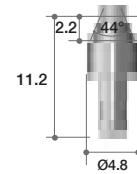

Temporary Cylinder

- Cylinder screw (MUAS) included
- For use with fabricating acrylic provisional restoration
- Grooves on post cylinder for storing resin adhesion
- Back-up screw is included
- Recommended torque: 15Ncm

Connection	Ref.C
Non-Hex	MUATCL

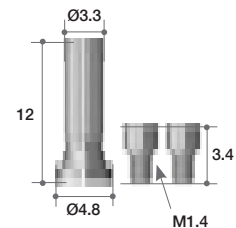

CCM Cylinder

- Cylinder screws (MUAS) 2EA included
- For use with fabricating screw-retained prosthesis with metal-reinforced or bar-structured overdenture
- Can be cast using non-precious dental alloys (Ni-Cr, Cr-Co alloys)
- Melting temperature of CCM base: 1300~1400°C
- Back-up screw included
- Recommended torque: 15Ncm

Connection	Ref.C
Non-Hex	MUACCML

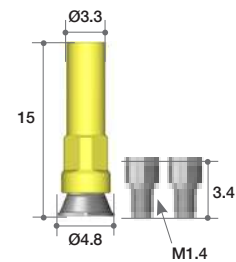

➔ Components for Multi-unit Abutments

Healing Cap

- Cylinder screws (MUAS) 2ea included
- Select size according to soft tissue volume or type of restoration

Type	Ref.C
Regular	MUAHCL
Wide	MUAHCWL

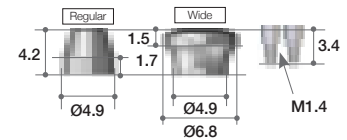

Healing Cap Set reference code

Order code: Add "P" after existing reference code

E.g.) MUAHCL → MUAHCP



Try-in Abutment

- Cuff height indicated with laser markings
- Straight, 17°, 30°
- Non-hex type

Angle	Cuff Marking	Ref.C
Straight	1.5 / 2.5 / 3.5 / 4.5	MUTIAAROR00C
		MUTIAARON00C
17°	2.5 / 3.5 / 4.5	MUTIAAROR17C
		MUTIAARON17C
30°	3.5 / 4.5	MUTIAAROR30C
		MUTIAARON30C

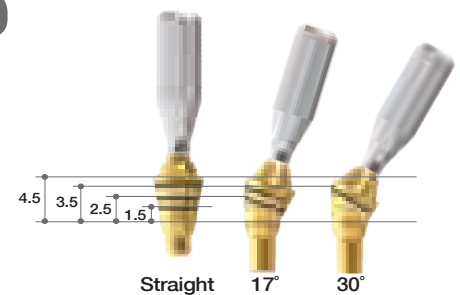

Try-in Abutment Set reference code

Order code: MUTIAARO00CP



- * Compatible systems: AnyRidge Internal, BLUEDIAMOND, AnyOne Internal, AnyOne External
- * Kit contents: Straight, 17°, 30° Try-in abutments (1 each)



Surgical Guide

- 7mm distance between lines
- Place center pin after initial drilling at center of arch

Angle	Marking Length (mm)	Ref.C
30°	7	MUSG70

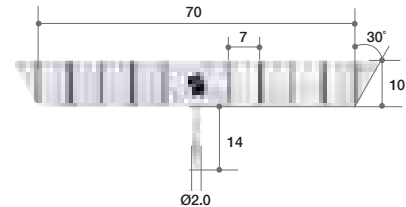

►► How to use Surgical Guide

- * For easy identification, surgical guide includes thicker lines for canines & second premolars, as most common indicators
- * Surgical guide can also be used with first molars

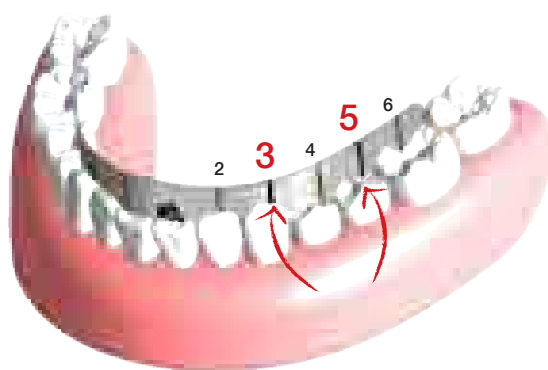
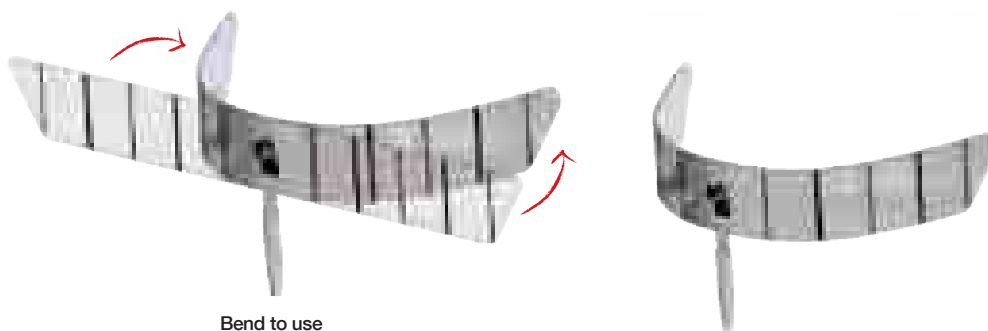

[Packaging]

II. Abutment-level Prosthesis

4. EZ CROWN & Components

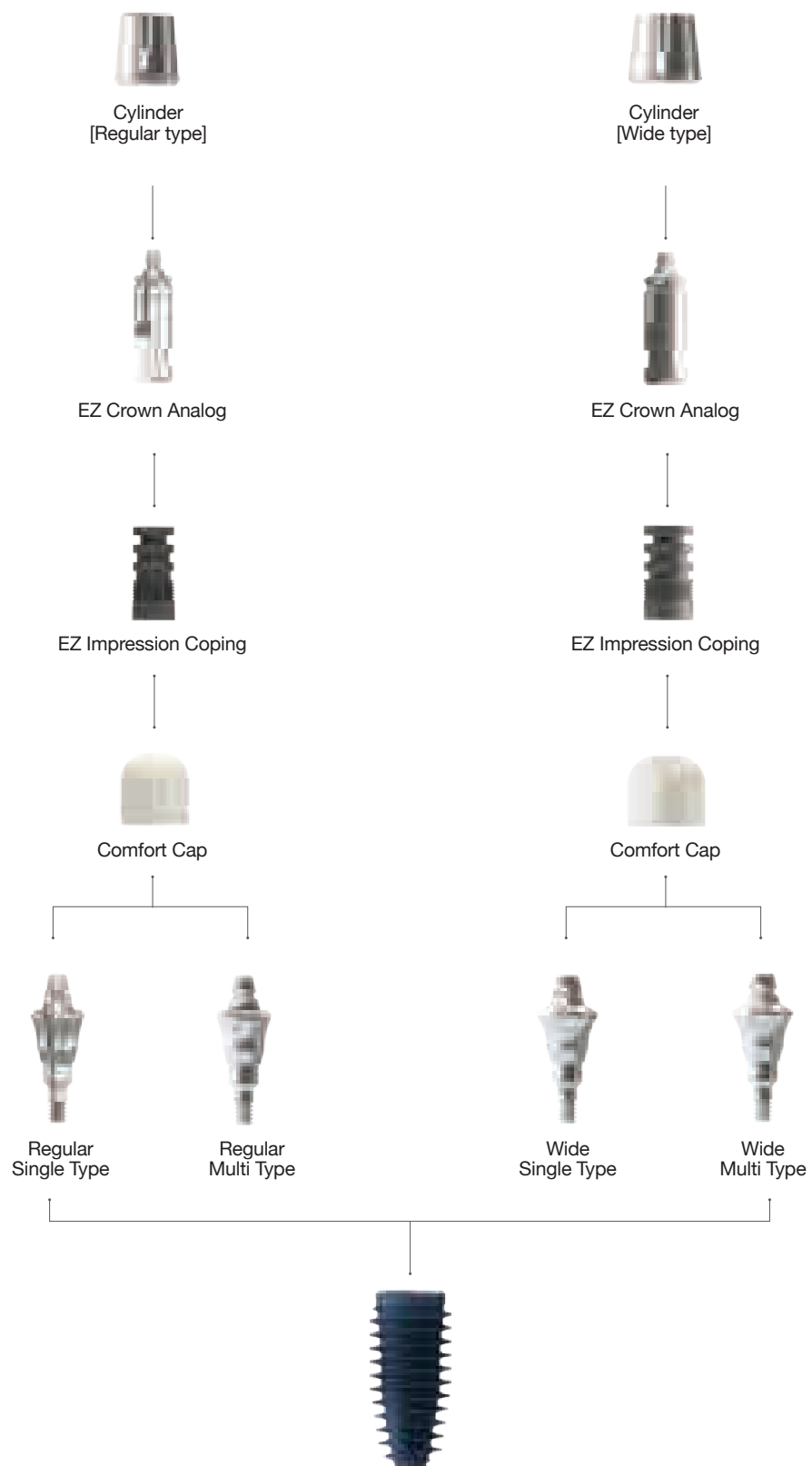

►► EZ CROWN

Imagine perfect prosthetics that can last a life-time!

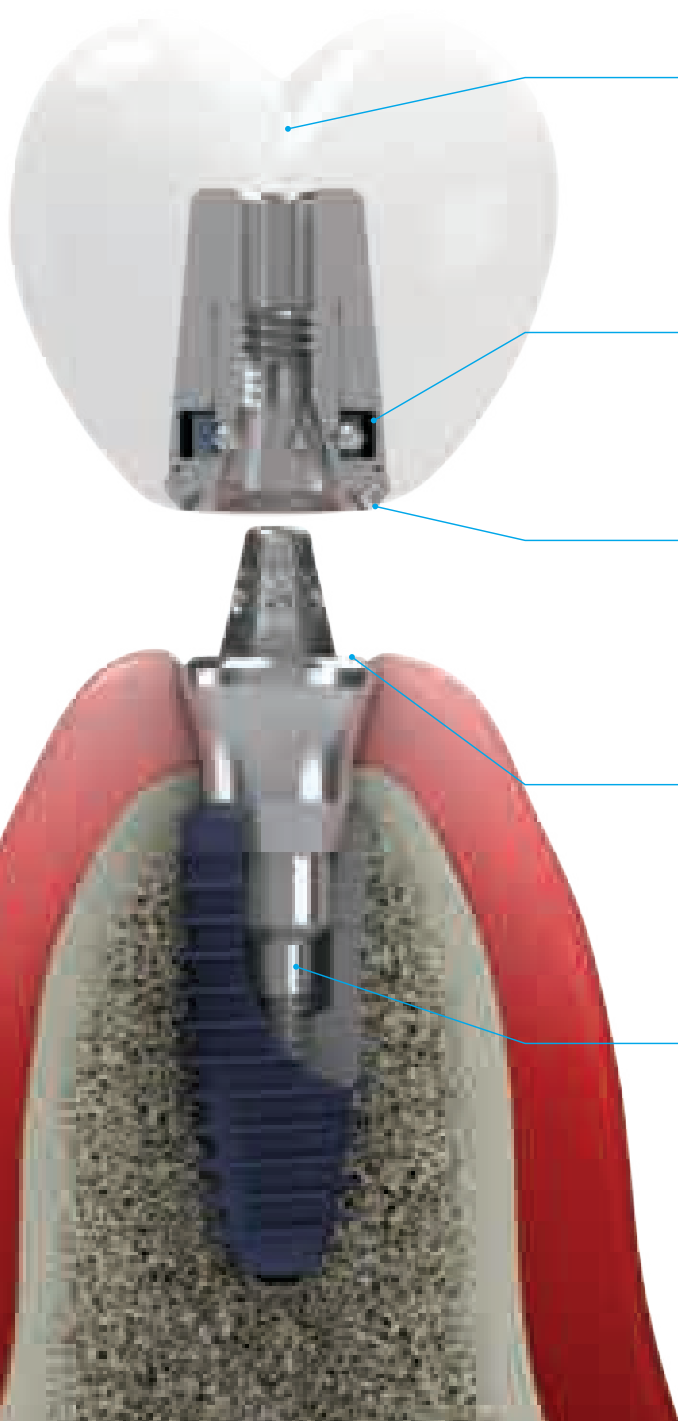

New concept for implant prosthetics

EZ locking connection between spherical grooves of abutment & Zirconia ball-Nitinol spring of cylinder creates screw-less implant for optimal occlusion & esthetics

High retrievability

EZ locking connection uses elastic Nitinol spring & flexible abutment structure that can compensate up to 12.5°, allowing easy retrieval of prosthesis, convenient fixture repair & effective treatment of any peri-implant inflammation

No cement

As EZ Crown abutment functions as convertible abutment, this allows all implant procedures to occur at gingival level, thereby improving the impression-taking, prosthesis fabrication & aftercare

New management & maintenance protocol

EZ Crown improves the entire treatment & aftercare process for both clinician & patient

Less sinking, less loosening

As the one-piece abutment is tightened into the fixture using a torque of 35N, this essentially eliminates the sinking problem inherent with an internal connection, while also safeguarding against screw loosening

Nitinol (shape-memory alloy) pan spring provides long-term retention

Nitinol (nickel/titanium alloy) is already widely used in aerospace & medical technology, and its special shape-memory characteristic ensures long-term retention of dental prosthetics.



EZ locking is more convenient for dental prosthetics

As shown in the table, EZ Crown is more flexible & convenient for all aspects of implant prosthetics.

	EZ CROWN	IN-EXT	CEMENT-RETAINED	SCREW-RETAINED	SCRIP
Screw Hole	No	Yes	No	Yes	Yes
Cement removal	Easy	Difficult	Difficult	Easy	Easy
Aesthetics	Excellent	Poor	Excellent	Poor	Poor
Repair	Easy	Easy	Difficult	Easy	Easy
Connection Level	Gingiva	Gingiva	Fixture	Fixture	Fixture
LOAD	Low	Low	High	High	High
Screw Loosening	Low	Low	High	High	High
Retrievability	Very Easy	Easy	Difficult	Easy	Easy

Only abutment-level impression... No impression coping or scan abutment

Another benefit of EZ Crown is easy impression work, just a normal impression - no impression coping or scan abutment – so less effort & shorter chair-time.



➔ Abutment Options

Abutments

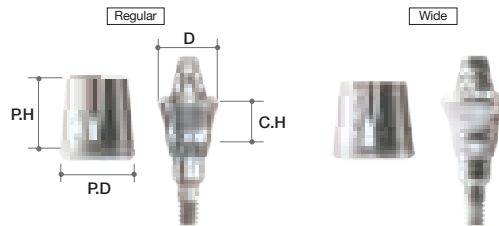

System	Profile Diameter	Cuff (mm)	Post Height (mm)	Ref.C	
				Single	Multi
BLUEDIAMOND IMPLANT	Regular (Ø 5.2)	1.0	3.8	IS52138BR	I52138BR
		2.0		IS52238BR	I52238BR
		3.0		IS52338BR	I52338BR
		4.0		IS52438BR	I52438BR
		5.0		IS52538BR	I52538BR
		1.0	5.0	IS52150BR	I52150BR
		2.0		IS52250BR	I52250BR
		3.0		IS52350BR	I52350BR
		4.0		IS52450BR	I52450BR
		5.0		IS52550BR	I52550BR
	Wide Type (Ø 6.0)	3.8	1.0	IS52165BR	I52165BR
			2.0	IS52265BR	I52265BR
			3.0	IS52365BR	I52365BR
			4.0	IS52465BR	I52465BR
			5.0	IS52565BR	I52565BR
		5.0	1.0	IS60138BR	I60138BR
			2.0	IS60238BR	I60238BR
			3.0	IS60338BR	I60338BR
			4.0	IS60438BR	I60438BR
			5.0	IS60538BR	I60538BR
5.0	1.0	IS60150BR	I60150BR		
	2.0	IS60250BR	I60250BR		
	3.0	IS60350BR	I60350BR		
	4.0	IS60450BR	I60450BR		
	5.0	IS60550BR	I60550BR		

➔ Components for EZ CROWN

Impression Coping

- Used for impression-taking on abutment level

Diameter	Type	Ref.C
Ø4.8	Regular	EIC
Ø5.5	Wide	EIC-W

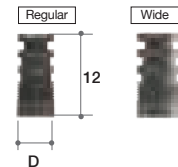

EZ CROWN Analog

Diameter	Type	Ref.C
Ø4.5	Regular	ECL
Ø4.95	Wide	ECL-W

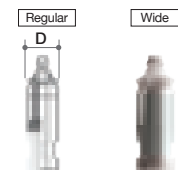

Comfort Cap

Diameter	Type	Ref.C
Ø5.0	Regular	ECH
Ø6.0	Wide	ECH-W

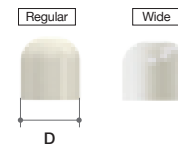

EZ Abutment Driver

- For connecting abutment

Diameter	Type	Ref.C
Ø4.0	Regular	EAD
Ø4.1	Wide	EAD-W

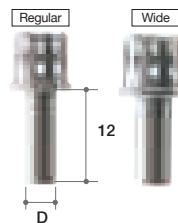

EZ Attach Driver

- For engaging & placing cylinderr

Diameter	Type	Ref.C
Ø6.5	Regular	EAAD
Ø7.9	Wide	EAAD-W

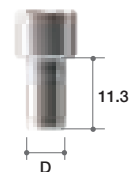

EZ Removal Driver

- For cylinder retrieval

Length(mm)	Ref.C
12	EARD

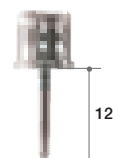

Instrument Set

- Abutment Driver + Cylinder Driver + Retrieval Driver

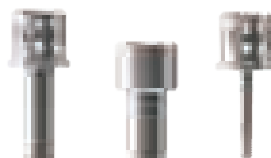

▶▶ How to use EZ CROWN



Connect Attach Driver to EZ Crown Abutment-Cylinder set

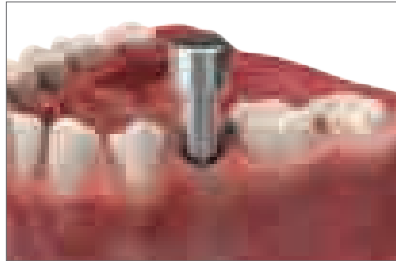

Connect the EZ Crown Abutment-Cylinder set to fixture using Attach Driver (by hand)



After basic tightening, remove Cylinder from EZ Crown Abutment using Remove Driver



Finally tighten EZ Crown Abutment to fixture using torque wrench & Abutment Driver (35N)



Re-connect Cylinder to EZ Crown Abutment & take an impression on cylinder level



Remove Cylinder from EZ Crown Abutment using Remove Driver

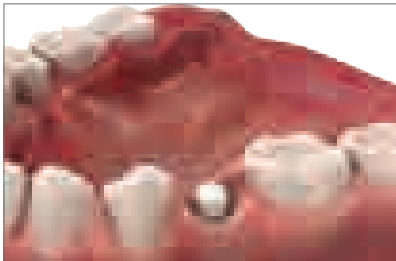

Connect Healing Cap to EZ Crown Abutment, then send Cylinder & impression model to Dental Lab

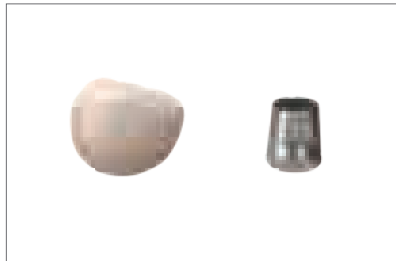

Final Crown & Cylinder



Re-tighten Cylinder & final crown to EZ Crown Abutment, then check occlusion



Remove Cylinder from EZ Crown Abutment using Remove Driver

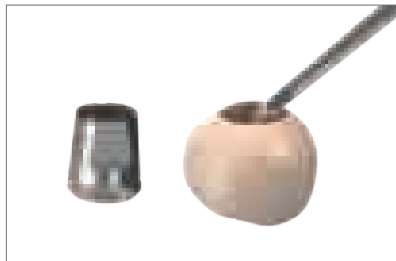

Cylinder & final crown cementation

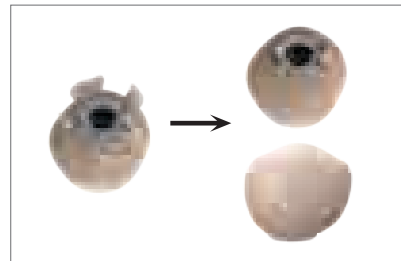

Remove excess cement



Final prosthesis

III. Overdenture Prosthesis

1. MegaGen Overdenture System

Meg-Loc

Compatible with products L & K, excellent functionality, & incomparable price!

- Combination of titanium housing & reinforced plastic (Pekkton) creates low water solubility and higher wear resistance and durability than other existing products
- Retention insert offers wide range of retention forces (600gf, 1200gf, 1800gf) to suit each patient, resulting in high level of satisfaction for both patient and dentist
- Strong physical properties of Pekkton and insert gap increase elasticity, so that insert does not tear or break, unlike conventional nylon products, thereby ensuring strong retention and longer life



Meg-Ball

Smallest housing, retentive ring with longer life!
Stable denture, even when implant angles are not parallel!

- Compatible with other products with Ø2.25 head size, minimizes patient inconvenience due to small-size housing, simpler to arrange artificial teeth as space occupied by denture is reduced, and easier to maintain than other systems
- Retentive ring has high elasticity, abrasion resistance, and durability, which doubles length of life when compared to silicone O-ring and guarantees longer life than NBR products
- Positioner (0/5/10/15 degrees) maintains parallel housing direction, even with tilted implant placement angles, ensuring denture stability

Meg-Magnet

Designed to maintain stable & sufficient magnetic force!
Blocks any bursts & corrosion resistant!

- Structure is connected with abutment using magnetic force, which is feasible even with insufficient bone volume or poor bone quality
- Easy to attach & detach, plus minimal inflammation
- Ø4.5 & Ø5.0 magnets are compatible with other products
- Laser markings on upper side for easy identification of up & down
- Sufficient magnetic force ensures stable retention
- Laser sealing to block any bursting phenomenon
- TiN coating for corrosion resistance
- Positioner (small & regular) prevents magnet from slipping in mouth & stops any flow of impression materials under abutment.

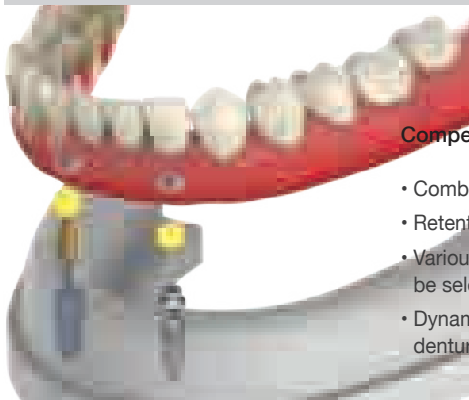
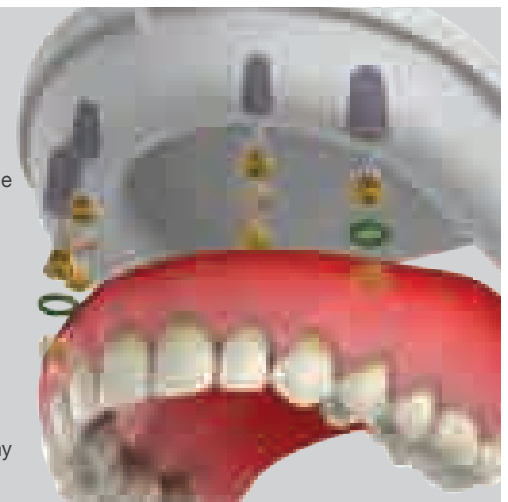

Meg-Rhein

Compensates for tilted implant placement angles up to 50°

- Combined head & housing structure is smallest on market
- Retentive cap is based on Italian technology and has uniform physical properties
- Various retention forces (600gf, 1200gf, 1800gf, 2700gf) classified by color can be selected according to each patient
- Dynamic housing with double structure enables tilting to 25°, allowing stable denture even with tilted implant placement angles

III. Overdenture Prosthesis

2. Meg-Loc Abutment & Components



Meg-Loc Metal Housing set



Block-out Spacer



Meg-Loc Abutment



►► Meg-Loc Overdenture System

Advantages

Easy compatibility

Compatible with Product L & Product K (same specifications)

Better abrasion resistance & durability

Combination of titanium housing & reinforced plastic (Pekkton) provides low water solubility & high resistance, making it superior in abrasion resistance & durability compared to existing products.

Water Sorption Test

Property	Meg-Loc (Pekkton)	Product L	Unit
Water Sorption	8.7	93.5	µg/mm ²

Stronger retention & longer life

Strong physical properties of Pekkton & gap in insert increase elasticity, preventing insert from being torn or broken, unlike existing nylon products, even with mismatched angles when attaching & removing denture.

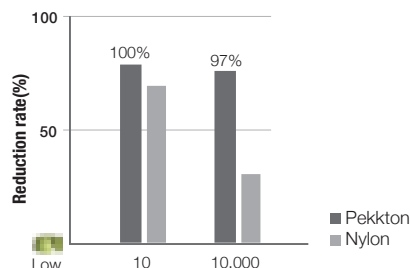

Easy to use

High resistance to plaque & easy cleaning
Easy replacement of retention insert

Tilting Angle



Various Retentive Caps for Meg-Loc

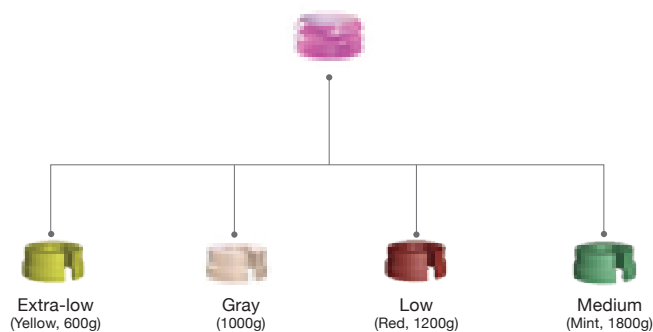

➔ Meg-Loc Overdenture System

Meg-Loc Abutment

- Angle compensation for one side 20° (both sides 40 °)
- Gently rounded shape
- Compatible with 1.2 Hex Driver
- Recommend torque : 35Ncm

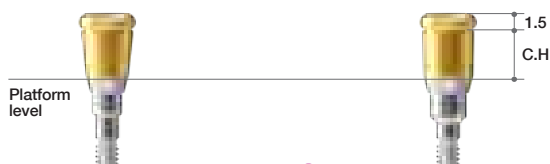

NC

Cuff Height (mm)	Ref.C
0	MLARON00
1.0	MLARON01
2.0	MLARON02
3.0	MLARON03
4.0	MLARON04
5.0	MLARON05
6.0	MLARON06
7.0	MLARON07

RC

Cuff Height (mm)	Ref.C
0	MLAROR00
1.0	MLAROR01
2.0	MLAROR02
3.0	MLAROR03
4.0	MLAROR04
5.0	MLAROR05
6.0	MLAROR06
7.0	MLAROR07

Meg-Loc Package

- 1 Meg-Loc Abutment

* Following package items are delivered with San DreMetto Korea packaging.

- 1 Titanium Housing
- 1 Block Out Spacer
- 4 Pekkton Retention Inserts (Yellow-600gf(for lab), Gray-1000gf, Red-1200gf, Mint-1800gf)



NC

Cuff Height (mm)	Ref.C
0	MLARON00P
1.0	MLARON01P
2.0	MLARON02P
3.0	MLARON03P
4.0	MLARON04P
5.0	MLARON05P
6.0	MLARON06P
7.0	MLARON07P



RC

Cuff Height (mm)	Ref.C
0	MLAROR00P
1.0	MLAROR01P
2.0	MLAROR02P
3.0	MLAROR03P
4.0	MLAROR04P
5.0	MLAROR05P
6.0	MLAROR06P
7.0	MLAROR07P

Meg-Loc Attachment

Description	QTY	Ref.C
CM-LOC Attachment	SET	CM-LOC
Titanium® Housing for Pekkton® Inserts	4EA	CM-LOC-TP
Processing Insert (extra-low)	4EA	CM-LOC-PI
Insert (extra-low)	4EA	CM-LOC-EL
Insert (low)	4EA	CM-LOC-L
Insert (medium)	4EA	CM-LOC-M
Block-out Spacer	4EA	CM-LOC-BS
Impression Part	4EA	CM-LOC-IP
Analog	4EA	CM-LOC-AN

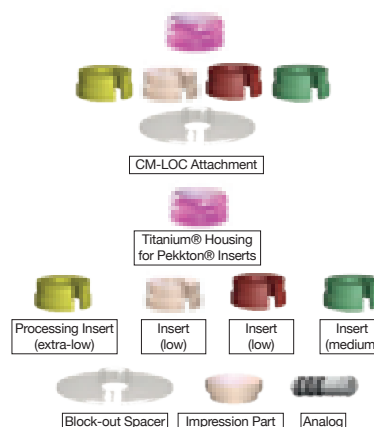

Multi Tool

- Retention Insert & Removal Tool

Ref.C
MLMT

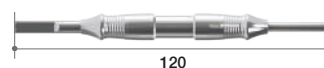

III. Overdenture Prosthesis

3. Meg-Ball Abutment & Components

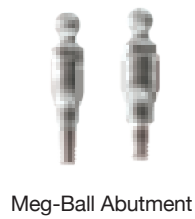

►► Meg-Ball Overdenture System

Advantages

Easy compatibility



Ø2.25 head size for easy compatibility with other products

Smallest Housing



Metal Housing

Small housing minimizes patient inconvenience, facilitates arrangement of artificial teeth by reducing space occupied by denture, & easier to maintain than other systems

Double length of life



Retentive Ring

High elasticity, abrasion resistance, & durability provide double length of life when compared with silicone O-ring & guaranteed longer life than NBR products

Stable denture even with mismatching implant placement angles

Positioner (0/5/10/15 degrees) maintains parallel housing direction even when angles of implant placement are mismatched, ensuring denture stability

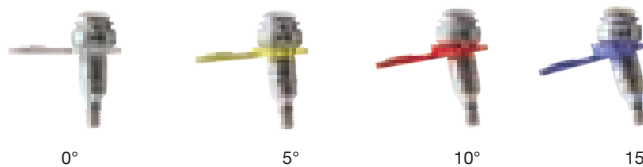

Tilting Angle



➔ Meg-Ball Overdenture System

Meg-Ball Abutment

- Angle compensation for one side 15° (both sides 30 °)
- Ø2.25 Ball shape
- Recommend torque : 35Ncm



NC

Cuff Height (mm)	Ref.C
0	MBARON00
1.0	MBARON10
2.0	MBARON20
3.0	MBARON30
4.0	MBARON40
5.0	MBARON50
6.0	MBARON60
7.0	MBARON70

RC

Cuff Height (mm)	Ref.C
0	MBAROR00
1.0	MBAROR10
2.0	MBAROR20
3.0	MBAROR30
4.0	MBAROR40
5.0	MBAROR50
6.0	MBAROR60
7.0	MBAROR70

Meg-Ball Package

- Meg-Ball Abutment
- Metal Housing Set
- Housing Positioner (0°, 5°, 10°, 15°)



NC

Cuff Height (mm)	Ref.C
0	MBARON00P
1.0	MBARON10P
2.0	MBARON20P
3.0	MBARON30P
4.0	MBARON40P
5.0	MBARON50P
6.0	MBARON60P
7.0	MBARON70P

RC

Cuff Height (mm)	Ref.C
0	MBAROR00P
1.0	MBAROR10P
2.0	MBAROR20P
3.0	MBAROR30P
4.0	MBAROR40P
5.0	MBAROR50P
6.0	MBAROR60P
7.0	MBAROR70P

Meg-Ball Metal Housing Set

- 1 Metal Housing
- 1 Retentive Ring

Ref.C
MBHR

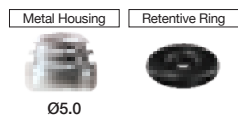

Retentive Ring Set

Quantity	Ref.C
5	MBR5
10	MBR10



Ball Driver

- For seating Ball Abutment in fixture
- Connects to Handpiece, Ratchet or Torque Wrench
- Available in long & short
- Refer to Page 76

Type	Ref.c
Torque Driver(Short)	TBT250S
Torque Driver(Long)	TBT250L

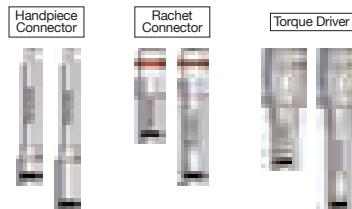



III. Overdenture Prosthesis

4. Meg-Magnet Abutment & Components

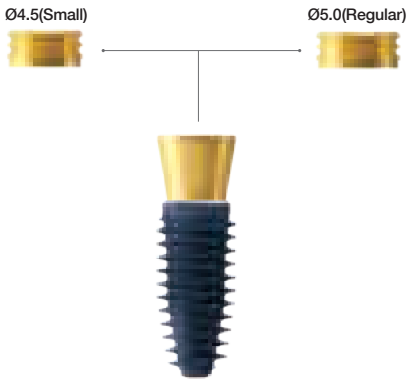

►► Meg-Magnet Overdenture System

<p>Advantages</p> <p>Easy to apply for elderly or disabled patients</p> <p>Designed for maximum magnetic efficiency & durability</p> <p>Outstanding retention</p> <ul style="list-style-type: none"> - Blocks bursting - Corrosion resistant - Abrasion resistant <p>Easy identification of up & down via laser</p> <p>No slippage of magnet</p>	<p>Applicable with insufficient bone volume & poor bone quality</p> <p>Easy to attach & detach</p> <p>Unlikely to cause inflammation</p> <p>Sufficient magnetic force (450gf, 650gf) to ensure stable retention</p> <p>Laser sealing blocks any bursting phenomenon</p> <p>TiN coating provides corrosion resistance</p> <p>Over 0.1mm thickness at contact with attachment to ensure wear resistance</p>  <p>Ø4.5 & Ø5.0 magnets are compatible with other products</p> <p>Laser markings on upper side for easy identification of up & down</p>  <p>Positioner (small & regular) prevents magnet from slipping in mouth & stops any flow of impression materials under abutment</p>  <p>Ø4.5 (350-450gf)</p> <p>Ø5.0 (550-650gf)</p>
<p>Meg-Magnet Components</p>	 <p>Ø4.5(Small)</p> <p>Ø5.0(Regular)</p>

➔ Meg-Magnet Overdenture System

Meg-Magnet Abutment

- Use with 1.2 Hex Driver
- Recommend torque : 35Ncm

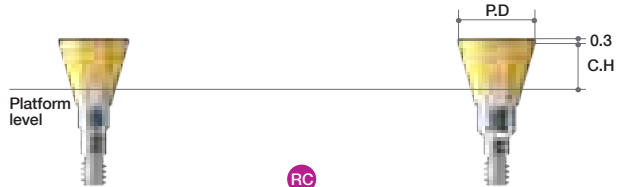

NC

Profile Diameter	Cuff Height (mm)	Ref.C
Ø4.5	0	MMARON400
	1.0	MMARON410
	2.0	MMARON420
	3.0	MMARON430
	4.0	MMARON440
	5.0	MMARON450
	6.0	MMARON440
Ø5.0	7.0	MMARON470
	0	MMARON500
	1.0	MMARON510
	2.0	MMARON520
	3.0	MMARON530
	4.0	MMARON540
	5.0	MMARON550
6.0	MMARON560	
7.0	MMARON570	

RC

Profile Diameter	Cuff Height (mm)	Ref.C
Ø4.5	0	MMAROR400
	1.0	MMAROR410
	2.0	MMAROR420
	3.0	MMAROR430
	4.0	MMAROR440
	5.0	MMAROR450
	6.0	MMAROR460
Ø5.0	7.0	MMAROR470
	0	MMAROR500
	1.0	MMAROR510
	2.0	MMAROR520
	3.0	MMAROR530
	4.0	MMAROR540
	5.0	MMAROR550
6.0	MMAROR560	
7.0	MMAROR570	

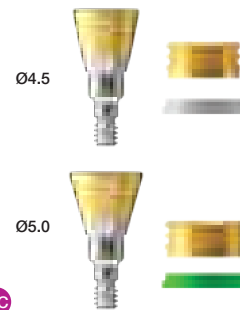
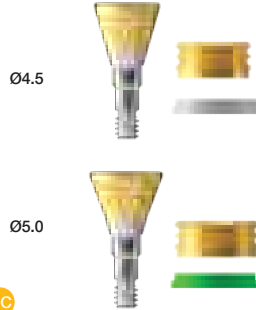

Meg-Magnet Package

- 1 Meg-Magnet Abutment
- 1 Magnet (Ø4.5-S, Ø5.0-R)
- 1 Magnetic Positioner

***Cautions!**

[Magnetic Positioners]

- Use according to standard
- : Small(White)/ Regular(Green)
- Do not reuse

[Magnets]

- Do not heat above 70°C
- : Magnetism is lost at high temperatures
- : For sterilization, use alcohol disinfection, not autoclave
- Remove if taking MRI.
- Avoid direct contact between magnets during procedure
- : Separation difficulties due to attraction forces

NC

Profile Diameter	Cuff Height (mm)	Ref.C
Ø4.5	0	MMARON400P
	1.0	MMARON410P
	2.0	MMARON420P
	3.0	MMARON430P
	4.0	MMARON440P
	5.0	MMARON450P
	6.0	MMARON460P
Ø5.0	7.0	MMARON470P
	0	MMARON500P
	1.0	MMARON510P
	2.0	MMARON520P
	3.0	MMARON530P
	4.0	MMARON540P
	5.0	MMARON550P
6.0	MMARON560P	
7.0	MMARON570P	

RC

Profile Diameter	Cuff Height (mm)	Ref.C
Ø4.5	0	MMAROR400P
	1.0	MMAROR410P
	2.0	MMAROR420P
	3.0	MMAROR430P
	4.0	MMAROR440P
	5.0	MMAROR450P
	6.0	MMAROR460P
Ø5.0	7.0	MMAROR470P
	0	MMAROR500P
	1.0	MMAROR510P
	2.0	MMAROR520P
	3.0	MMAROR530P
	4.0	MMAROR540P
	5.0	MMAROR550P
6.0	MMAROR560P	
7.0	MMAROR570P	

Meg-Magnet Attachment Set

Size	Ref.C
Small	MA402
Regular	MA502

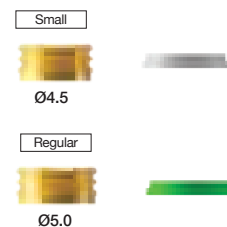

III. Overdenture Prosthesis

5. Meg-Rhein Abutments & Components

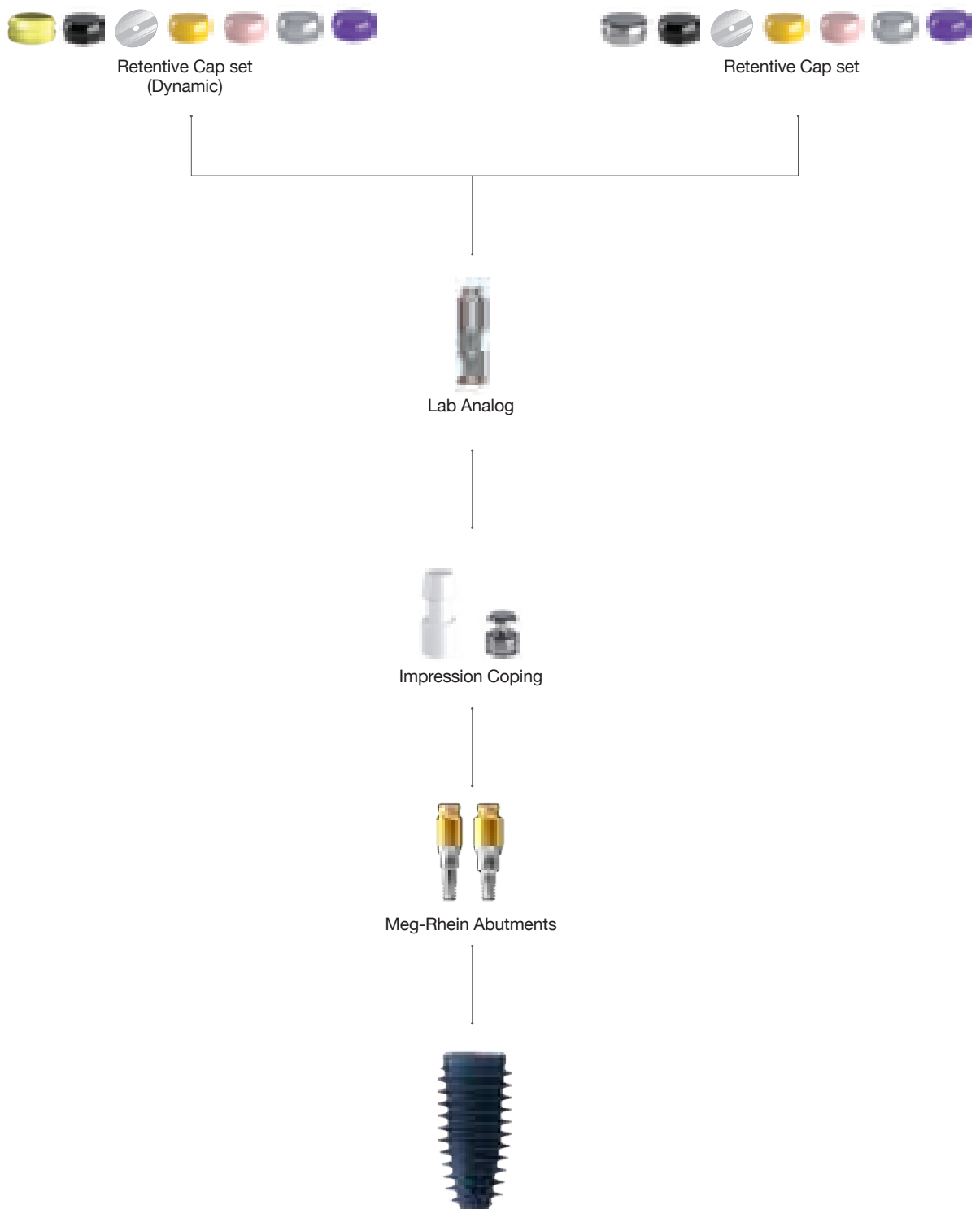

►► Overdenture System

Advantages

Small & Easy-to-use Housing System 

Tilting Angle

Various Retentive Caps for Meg-Rhein

Low Reduction Rate & Uniform Variance of Retentive Force

Normal

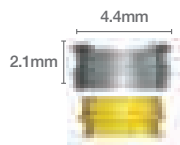

NEW!!

Dynamic

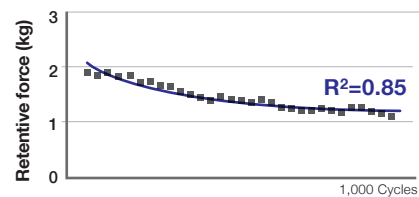
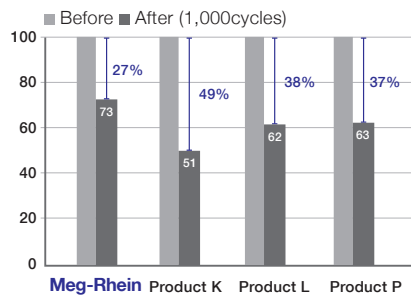
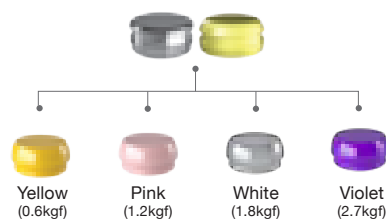
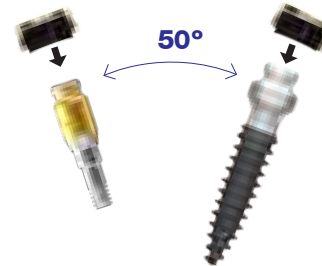
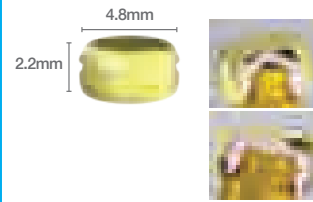

R^2 (Coefficient of determination) becomes more reliable when it is close to "1".

➔ Meg-Rhein Abutment Overdenture System

Meg-Rhein Abutments

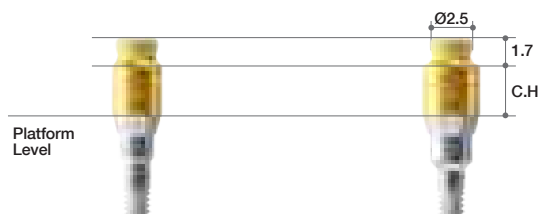

Meg-Rhein Overdenture System

(Dynamic)

- 1 Meg-Rhein Abutment
- 1 Plastic Impression Coping
- 1 Stainless Steel Housing (Dynamic) & Black-Lab
- 1 Protective Disk
- 4 Retentive Caps (Yellow-0.6kgf, Pink-1.2kgf, White-1.8kgf, Violet-2.7kgf)

- Perfect compatibility with Rhein83 from Italy
- Recommended torque: 35Ncm

NC

Cuff Height (mm)	Ref.C
0	ARODN00PA
1.0	ARODN01PA
2.0	ARODN02PA
3.0	ARODN03PA
4.0	ARODN04PA
5.0	ARODN05PA
6.0	ARODN06PA

RC

Cuff Height (mm)	Ref.C
0	ARODR00PA
1.0	ARODR01PA
2.0	ARODR02PA
3.0	ARODR03PA
4.0	ARODR04PA
5.0	ARODR05PA
6.0	ARODR06PA

Meg-Rhein Overdenture System

(Normal)

- 1 Meg-Rhein Abutment
- 1 Plastic Impression Coping
- 1 Stainless Steel Housing
- 1 Protective Disk
- 5 Retentive Caps (Black-Lab, Yellow-0.6kgf, Pink-1.2kgf, White-1.8kgf, Violet-2.7kgf)

- Perfect compatibility with Rhein83 from Italy
- Recommended torque: 35Ncm

NC

Cuff Height (mm)	Ref.C
0	ARODN00P
1.0	ARODN01P
2.0	ARODN02P
3.0	ARODN03P
4.0	ARODN04P
5.0	ARODN05P
6.0	ARODN06P

RC

Cuff Height (mm)	Ref.C
0	ARODR00P
1.0	ARODR01P
2.0	ARODR02P
3.0	ARODR03P
4.0	ARODR04P
5.0	ARODR05P
6.0	ARODR06P



➔ Components for Meg-Rhein Abutments

Stainless Steel Housing

- 5ea/pack

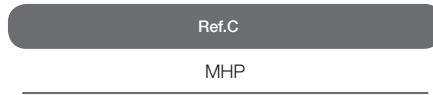

Stainless Steel Housing

(Dynamic)

- 5ea/pack

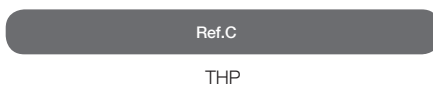

Retentive Caps (White)

- White cap(1.8kgf) - for refill (5ea/pack)
- For more retentive force following pink cap(1.2kgf)

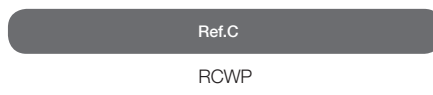

Retentive Caps (Violet)

- Violet cap(2.7kgf) - for refill (5ea/pack)
- For more retentive force following white cap(1.8kgf)

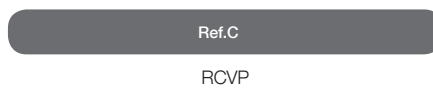

Retentive Caps (Pink)

- Pink cap(1.2kgf) - for refill (5ea/pack)

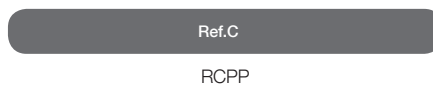

Retentive Caps (Yellow)

- Yellow cap(0.6kgf) - for refill (5ea/pack)

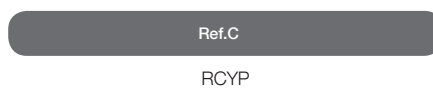

Retentive Caps (Black)

- For laboratory

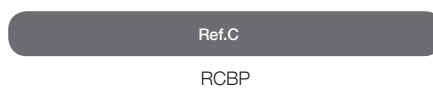

Stainless Impression Coping (Pick-Up)

- 2ea/pack.
- Italy - Rhein 83 products.
- For accurate (pick-up type) impression
- Groove design prevents swaying

Ref.C
044CAIN



Lab Analog

Ref.C
PLA



Retentive Cap Removal Tool

Ref.C
091EC

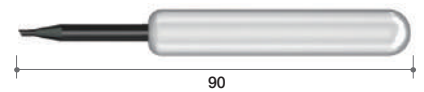

Retentive Cap Insertion Tool

Ref.C
085IAC

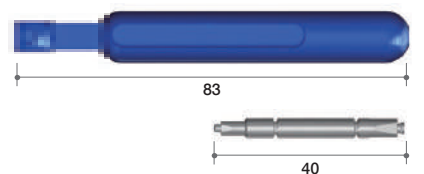

BLUEDIAMOND Kits

I. Surgical Kit : Standard Type

Ref.C

KARO3003

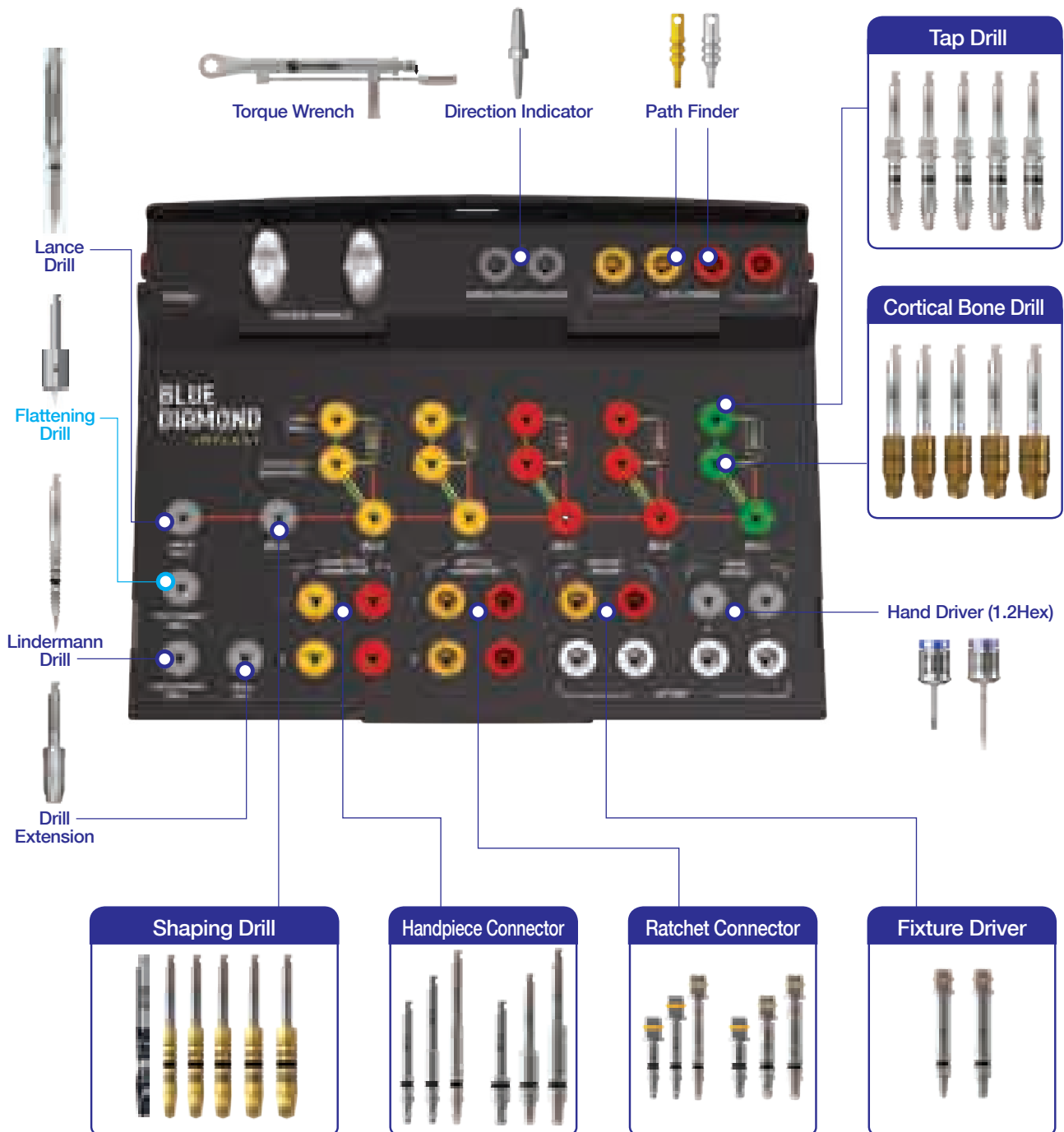





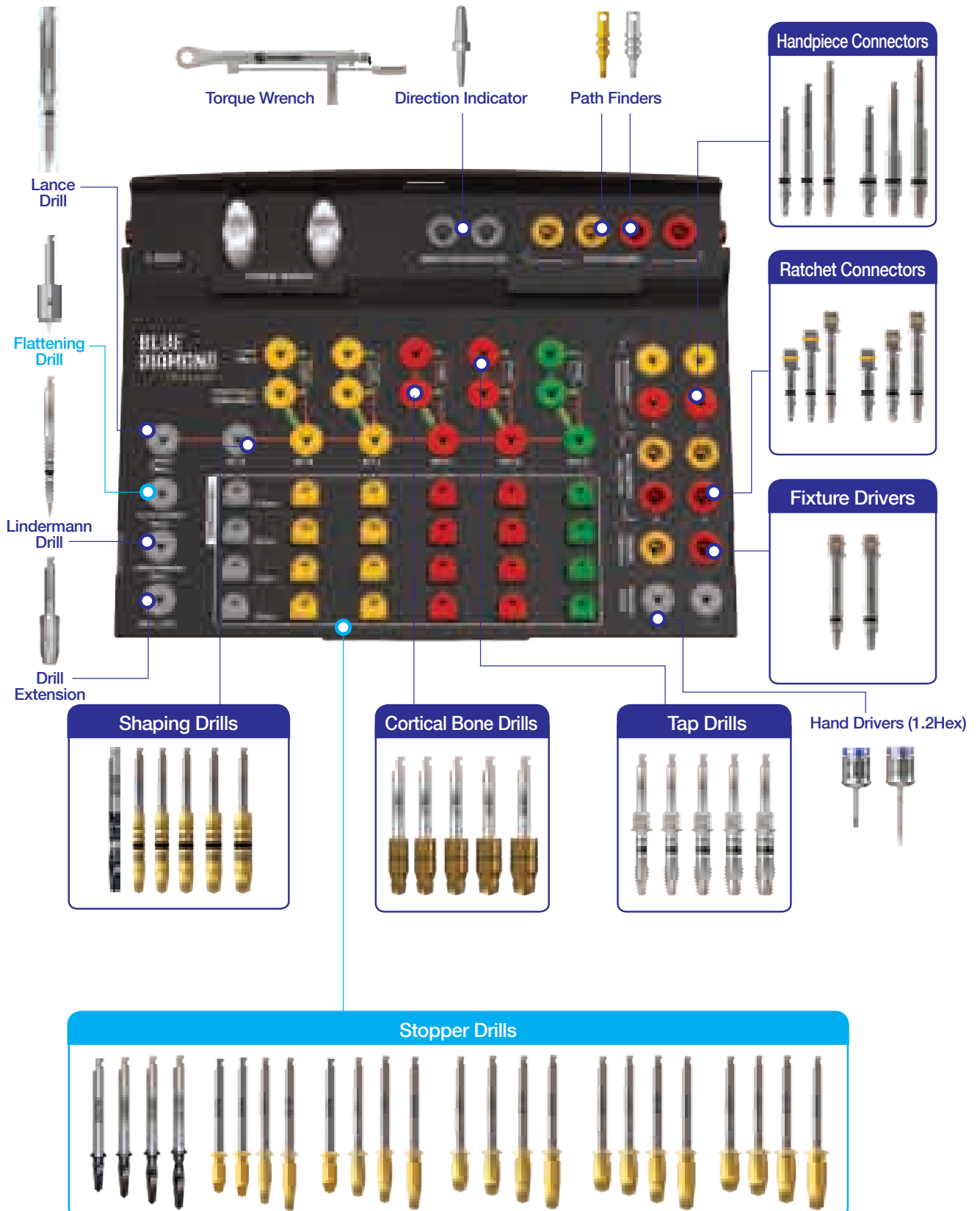





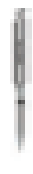











I. Surgical Kit

Ref.C
KAR03001



▶▶ Drilling Protocols

- BLUEDIAMOND® implants achieve optimum initial stability when used with a guided drilling sequence
- BLUEDIAMOND implants should be placed 1mm sub-crestal
- 0.5 ~1mm sub-crestal placement has been proven to show a better crestal bone response

	Flattening Drill	Lance	Shaping Drills						Cortical Bone Drills					Tap Drills					Stopper Drills					
	Ø5.0 / Ø2.0	Ø2.0	Ø2.5	Ø2.9	Ø3.3	Ø3.6	Ø3.9	Ø4.3	Ø3.6	Ø4.0	Ø4.4	Ø4.7	Ø5.0	Ø3.3	Ø3.7	Ø4.1	Ø4.4	Ø4.8	Ø2.5	Ø2.9	Ø3.3	Ø3.6	Ø3.9	Ø4.3
																								
rpm max	400-600	800	800	600	600	500	500	400	300					15					800	600	600	500	500	400

Standard Type
Full Type

Ø3.3 Fixture Drilling Sequence

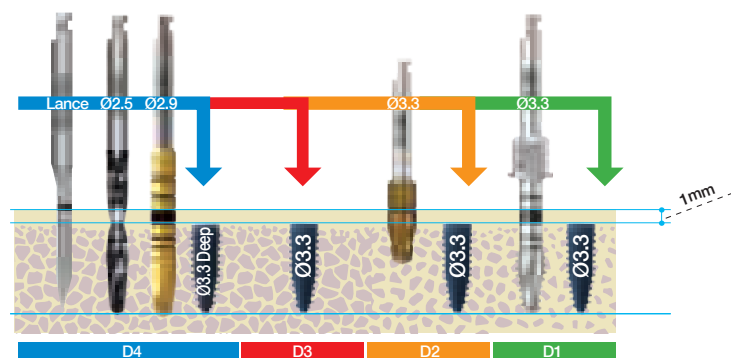
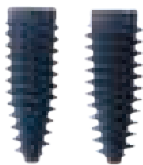

Ø3.7 Fixture Drilling Sequence

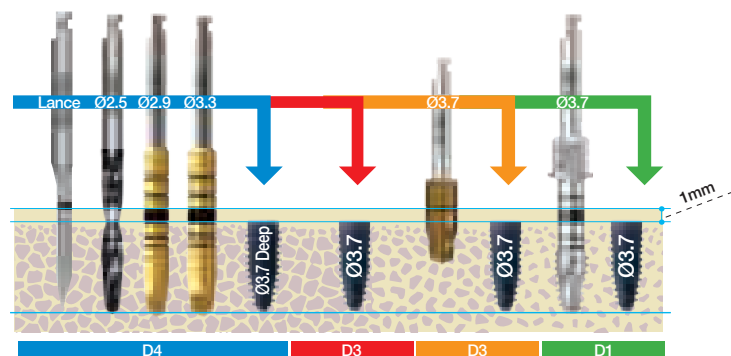

**Ø4.1 Fixture
Drilling Sequence**

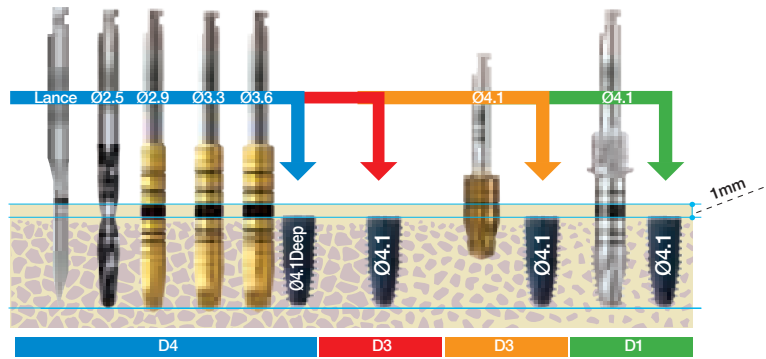

**Ø4.4 Fixture
Drilling Sequence**

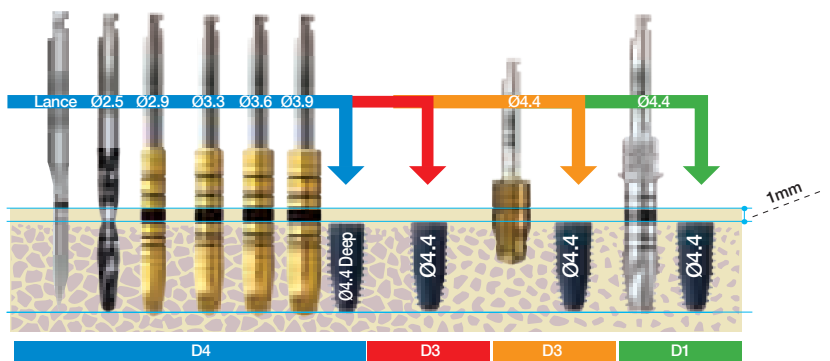

**Ø4.8 Fixture
Drilling Sequence**

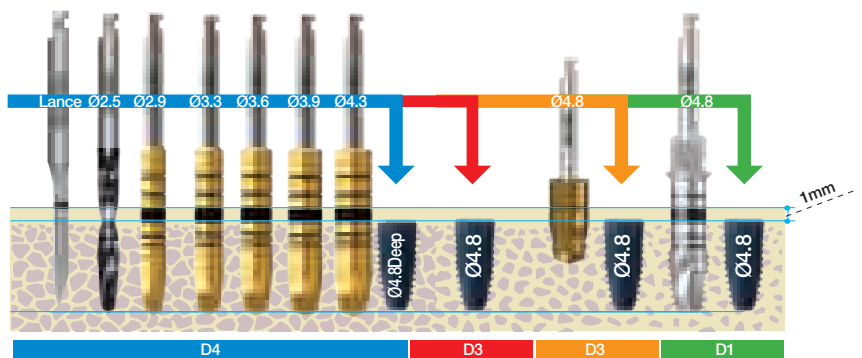
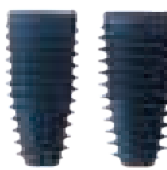

➔ Surgical Kit Components

Lance Drill

- Use to make indentation in cortical bone to confirm exact drilling location

Diameter	Type	Ref.C
Ø2.0	Long	MGD100L

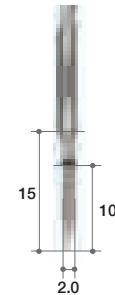

Lindermann Drill

- Cross-cutting on drill shank
- Use to correct path during drilling

Length(mm)	Shank Length(mm)	Ref.C
Ø2.5	15 (Short)	LDMD2515
	20 (Middle)	*LDMD2520
	25 (Long)	*LDMD2525

(*) Separate sales item

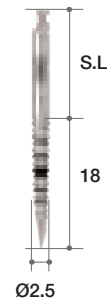

Flattening Drill

- Use to flatten irregular bone & allow exact drilling with stopper drills
- Designed to engage with Flattening Lance & 2 kinds of Housing to match diameters of different final drills (Ø5.0 & Ø6.0)
- Ø5.0 = Stopper Drill Ø2.0 ~ Ø4.3
- Ø6.0 = Stopper Drill Ø4.8 ~ Ø5.4
- Housing boundary becomes indicator for drilling position of next fixture

Diameter	Length(mm)	Ref.C
Ø5.0 / Ø2.0	3.5	FD5020
*Ø6.0 / Ø2.0		FD6020

(*) Separate sales item

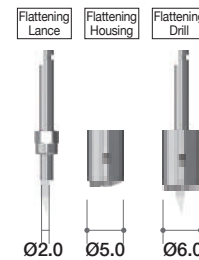

1

• Flattening Drill ensures correct drilling position for accurate fixture placement
(If final drill diameter is Ø2.0~Ø4.3, use Ø5.0 Housing, if final drill diameter is Ø4.8, Ø5.4, use Ø6 Housing)

2

• Drilling sequence should consider fixture size & bone density

3

• Place fixture using Handpiece & Ratchet Connector

Shaping Drills

- Each drill has depth markings from 7.0mm to 15.0mm
- Dual marking system (grooves & laser markings) provides visual & radiographic depth verification during surgery
- TiN coating on drills for enhanced corrosion resistance & abrasion resistance
- * Actual drill length does not normally include Y dimension of drill
- * Markings on Shaping Drills are 0.8mm longer than fixture, so fixtures will automatically be placed 1mm sub-crestally if drilling protocol is followed

Diameter	Blade Length(mm)	Shank Length(mm)	Ref.C
Ø2.5	18	15(Short)	SD2518S
		25(Long)	*SD2518L
Ø2.9		15(Short)	AROSD2918S
		25(Long)	*AROSD2918L
Ø3.3		15(Short)	AROSD3318S
		25(Long)	*AROSD3318L
Ø3.6		15(Short)	AROSD3618S
		25(Long)	*AROSD3618L
Ø3.9		15(Short)	AROSD3918S
		25(Long)	*AROSD3918L
Ø4.3	15(Short)	AROSD4318S	
	25(Long)	*AROSD4318L	

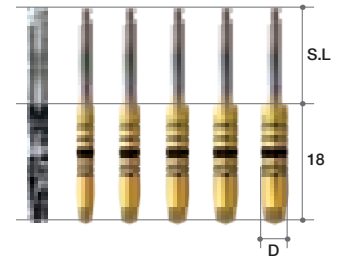

(*) Separate sales item

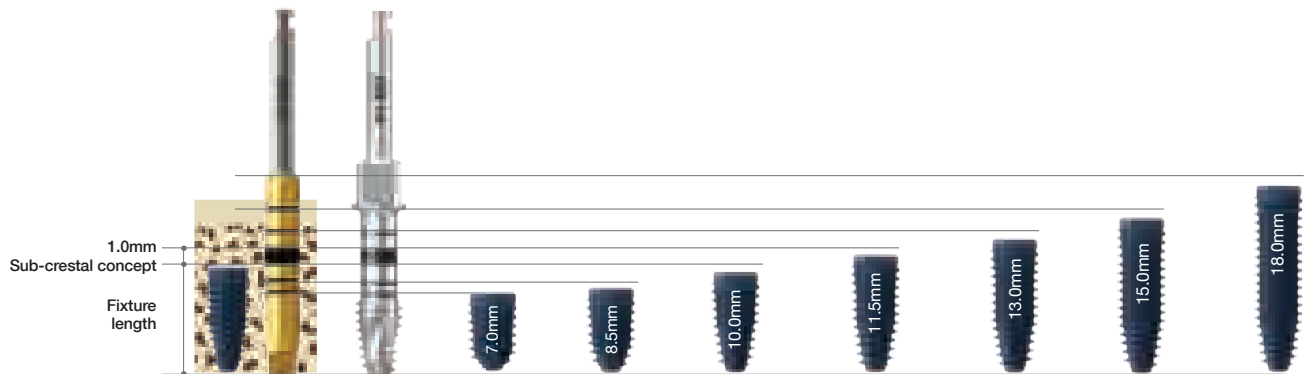

➔ Surgical Kit Components

Stopper Drills

- Each diameter has drill lengths of 7.0 / 8.5 / 10 / 11.5mm
- TiN coating on drills for enhanced corrosion resistance & abrasion resistance

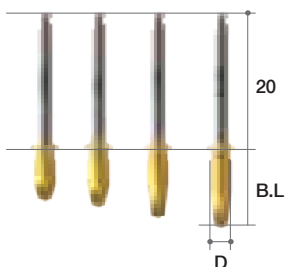

Diameter	Blade Length(mm)	Ref.C
Ø2.5	7.0	SD2507M
	8.5	SD2508M
	10	SD2510M
	11.5	SD2511M
Ø2.9	7.0	AROSD2907M
	8.5	AROSD2908M
	10	AROSD2910M
	11.5	AROSD2911M
Ø3.3	7.0	AROSD3307M
	8.5	AROSD3308M
	10	AROSD3310M
	11.5	AROSD3311M
Ø3.6	7.0	AROSD3607M
	8.5	AROSD3608M
	10	AROSD3610M
	11.5	AROSD3611M
Ø3.9	7.0	AROSD3907M
	8.5	AROSD3908M
	10	AROSD3910M
	11.5	AROSD3911M
Ø4.3	7.0	AROSD4307M
	8.5	AROSD4308M
	10	AROSD4310M
	11.5	AROSD4311M



Cortical Bone Drills

- Use to remove & shape cortical bone to control initial stability in dense bone (type II)
- TiN coating on drills for enhanced corrosion resistance & abrasion resistance

Diameter	Blade Length(mm)	Shank Length(mm)	Ref.C
Ø3.6	10	15	AROCD33
Ø4.0			AROCD37
Ø4.4			AROCD41
Ø4.7			AROCD44
Ø5.0			AROCD48

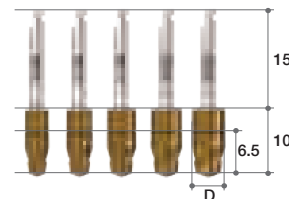

Tap Drills

- Can be used with both Handpiece (dental implant engine) & Ratchet Wrench

Diameter	Marking	Ref.C
Ø3.6	7 / 8.5 / 10 / 11.5 / 13 / 15	AROTD33
Ø4.0		AROTD37
Ø4.4		AROTD41
Ø4.7		AROTD44
Ø5.0		AROTD48

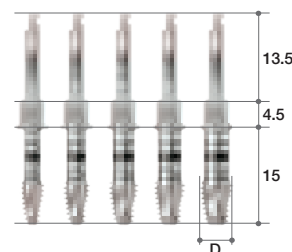

Handpiece Connectors

- Use with Handpiece when removing fixture from ampule & placing fixture
- Spring-type connection allows easy & secure pick-up & positioning of fixture
- First mark on shaft indicates position of fixture platform
- Bottom & top of black line indicate 3mm & 4mm from fixture platform, respectively
- Especially useful in flapless surgery
- * Use RC Connector as mount

Length (mm)	Type	Connection (mm)	Ref.C
5	Ultra-short	Octa. 2.05	AROHCU21
10	Short		AROHCS21
15	Long		AROHCL21
5	Ultra-short	Octa. 2.5	AROHCU25
10	Short		AROHCS25
15	Long		AROHCL25

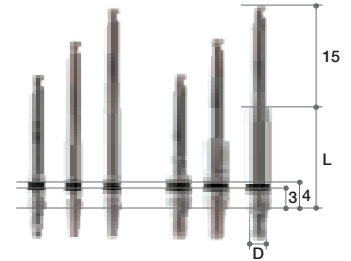

Ratchet Connectors

- Use with Ratchet Wrench when inserting or removing fixture
- Make sure Ratchet Connector is securely seated in Ratchet Wrench before using
- Excessive force can cause damage to internal Octa of fixture
- Marks on shaft indicate position of fixture platform
- Bottom & top of black line indicate 3mm & 4mm from fixture platform, respectively
- Especially useful in flapless surgery
- * Use RC Connector as mount

Length (mm)	Type	Connection (mm)	Ref.C
5	Ultra-short	Octa. 2.05	ARORCU21
10	Short		ARORCS21
15	Long		ARORCL21
5	Ultra-short	Octa. 2.5	ARORCU25
10	Short		ARORCS25
15	Long		ARORCL25

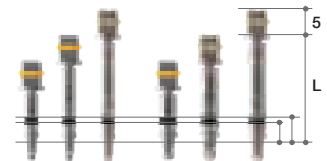

Fixture Driver

- If Ratchet Connector breaks from over-torquing during placement, connect Fixture Driver to Torque Wrench (Ratchet type) to remove fixture
- Excessive force can cause damage to internal Octa of fixture

Length (mm)	Connection (mm)	Ref.C
15	Octa. 2.05	AROFDN
	Octa. 2.5	AROFDR

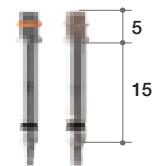

Hand Driver (1.2 Hex)

- For use with all Cover Screws, Abutment Screws & Healing Abutments
- 4 lengths available
- Directly insert into Torque Wrench without adapter
- Hex tip can withstand 35-45Ncm of torque
- without distortion

Length(mm)	Type	Ref.C
5	*Ultra-short	TCMHDU1200
10	Short	TCMHDS1200
15	Long	TCMHDL1200
20	*Extra-long	TCMHDE1200

(*) Separate sales item

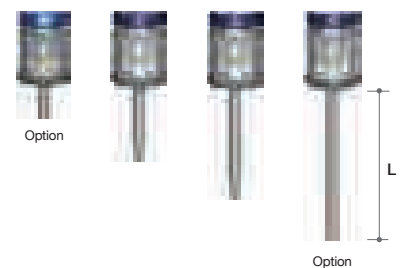

➔ Surgical Kit Components

Drill Extension

- For extending drills & other handpiece tools
- Up to 35Ncm torque: can be distorted when too much force is applied

Ref.C
MDE150



Direction Indicator

- Confirms drilling direction & functions as parallel guide for additional osteotomies
- Each end of Direction Indicator has different diameter - Ø2.0 & Ø2.8.

Length (mm)	Ref.C
Ø2.0 / Ø2.8	MDI100



Path Finder

- Use to guide parallel placement of subsequent fixtures
- Grooves measure gingival depth, especially useful for flapless surgery

Length(mm)	Type	Ref.C
10	NC	AROPFN
	RC	AROPFR

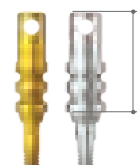

Torque Wrench (Ratchet type)

- Torque range: 15Ncm to 45Ncm
- Use for implant placement & final tightening of abutment screw

Type	Ref.C
Torque Wrench	TWSQ70



Torque Wrench & Adapter

- Torque range: 15Ncm to 45Ncm
- Use for implant placement & final tightening of abutment screw

Type	Ref.C
*Torque Wrench	MTW300A
*Torque Wrench Adapter (Handpiece)	TTA100
*Torque Wrench Adapter (Ratchet)	TTAR100

(*) Separate sales item

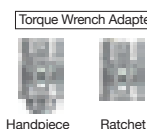

II. Prosthetic Kit

Includes various drivers required for prosthetics

Ref.C
KANPK3000

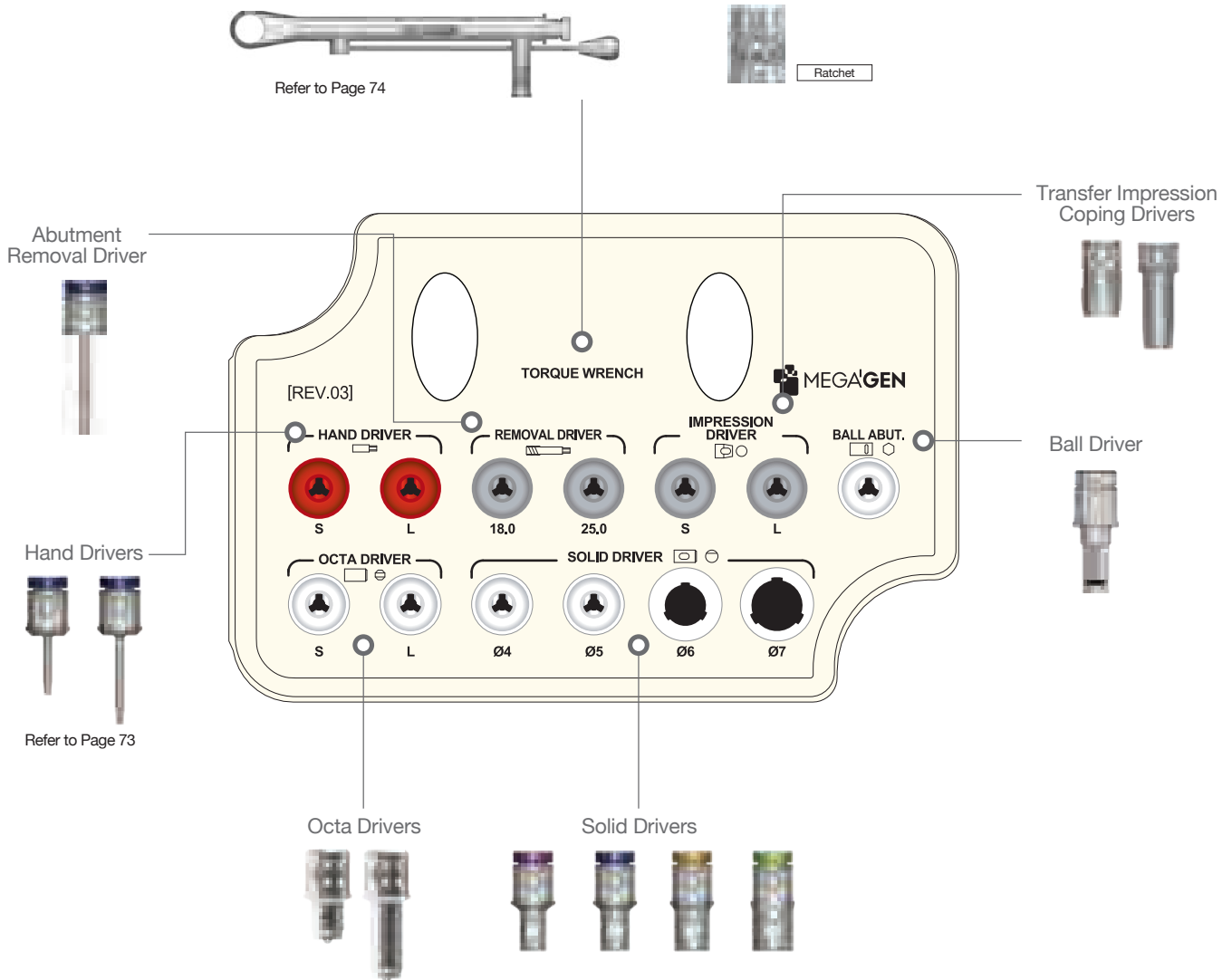

➔ Prosthetic Kit Components

Solid Driver

- For delivering solid abutment
- Color coded: Ø4-magenta, Ø5-blue, Ø6-yellow, Ø7-green
- Heights: 8.5 & 13.5mm
- Directly connectable to Torque Wrench

Solid Abutment Profile Diameter	Length(mm)	Ref.C
Ø4	8.5	TANSDS400
	13.5	*TANSDL400
Ø5	8.5	TANSDS500
	13.5	*TANSDL500
Ø6	8.5	TANSDS600
	13.5	*TANSDL600
Ø7	8.5	TANSDS700
	13.5	*TANSDL700



(*) Separate sales item

Octa Driver

- For seating Octa Abutment into fixture
- Can also be connected to Torque Wrench

Length(mm)	Ref.C
7	MOD300S
13	MOD300L

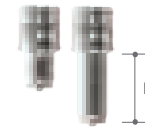

Ball Driver

- For seating Ball Abutment into fixture
- Connections for Handpiece, Ratchet & Torque Wrench
- Available as long or short

Type	Ref.C
*Handpiece Connector(Short)	TBH250S
*Handpiece Connector(Long)	TBH250L
*Ratchet Extension(Short)	TBR250S
*Ratchet Extension(Long)	TBR250L
*Torque Driver(Short)	TBT250S
Torque Driver(Long)	TBT250L

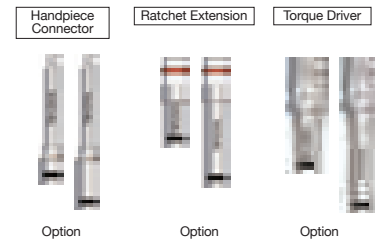

(*) Separate sales item

Impression Coping Driver (Transfer)

- For transfer-type impression coping
- Works with friction only
- Small yet powerful grip

Type	Ref.C
For two-piece impression coping	TCMID
For one-piece impression coping	TCMIDE

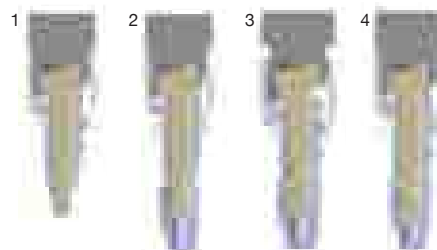

1. Connect Impression Coping & Impression Driver
2. Adjust connection with fixture by turning Holder clockwise
3. Push Holder & insert Impression Coping into fixture.
4. Turn Driver clockwise to ensure connection of Impression Coping & Fixture.

III. Bone Profiler Kit

Removes overhanging bone around fixture to allow adequate seating of Healing Abutment or Prosthetic Abutment

Ref.C
KAROBP3000

- Insert guide pin into fixture & select appropriate Bone Profiler
- Kit includes 4 sizes of bone profiler & 4 guide pins

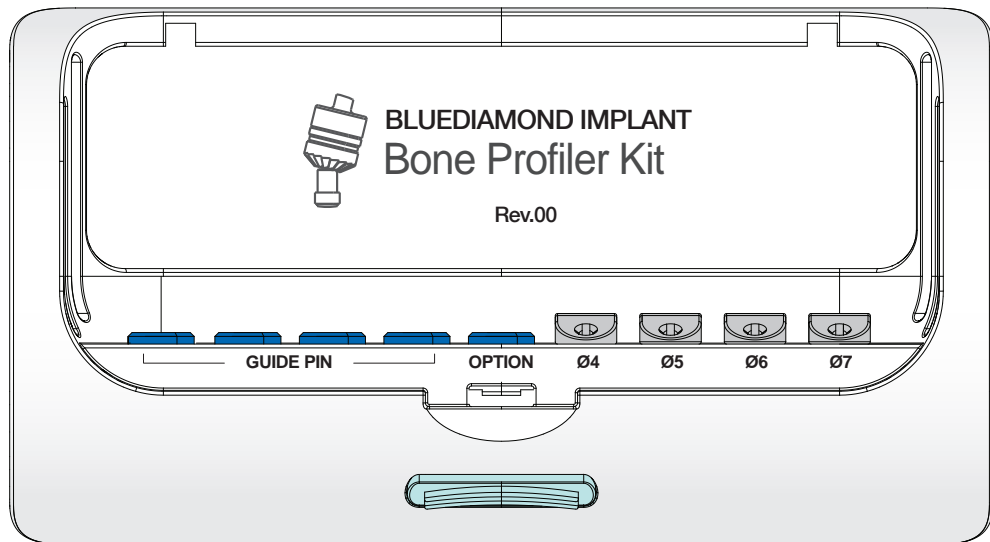

Bone Profiler

- Guide pin (AROBPG) included

- Each bone profiler can be purchased separately, as refill
- Each package includes bone profiler & guide pin

Profile Diameter	Length (mm)	Ref.C
Ø4	13	AROBP40G
Ø5		AROBP50G
Ø6	8	AROBP60G
Ø7		AROBP70G

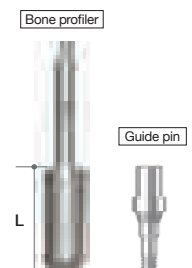

IV. Optional Components (continued)

- not included in surgical kit
- may be purchased separately & placed in spaces provided in surgical kit

Tissue Punch

- For removing soft tissue from osteotomy socket, especially useful in flapless surgery
- Identify soft tissue thickness using laser marking at 2mm
- Minimizes loss of soft tissue in flapless surgery
- Can stop bleeding when used with healing abutment

Diameter	Marking	Ref.C
In. Ø3 / Out. Ø4	2mm	TCMTPM0304
In. Ø4 / Out. Ø5		TCMTPM0405
In. Ø5 / Out. Ø6		TCMTPM0506
In. Ø6 / Out. Ø7		TCMTPM0607
In. Ø7 / Out. Ø8		TCMTPM0708

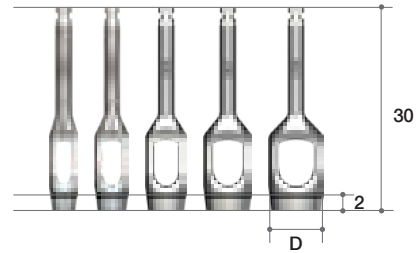

Hand Tap

- Useful when internal screw of fixture has been damaged
- For re-tapping disabled thread
- Caution: use of excessive force can cause further damage, so apply force slowly & gradually

Length(mm)	Type	Ref.C
10	M1.6	THT160L

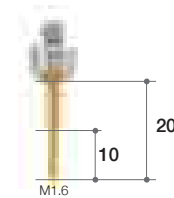

Ratchet Wrench

- Used to exert more force than Handpiece
- No bearing system: no breakage or corrosion problems
- Attaches to Ratchet Extension
- Arrow laser marking indicates direction of force

Ref.C
MRW040S



Trephine Burs

- Use to minimize drilling steps, especially for wider fixtures
- Helpful for collecting autogenous bone
- Useful for removing failed & fractured fixtures
- Depth markings are 7, 8.5, 10, 11.5, 13mm, same as fixture depths (no Y dimension, so markings are actual length)
- Markings on drill shaft represent inside / outside diameter of Trephine Burs

Diameter	Type	Ref.C
Ø3.5 (in Ø2.5)	Short	TANTBL2535
Ø5.0 (in Ø4.0)		TANTBL4050
Ø6.0 (in Ø5.0)		TANTBL5060
Ø7.0 (in Ø6.0)		TANTBL6070
Ø3.5 (in Ø2.5)	Long	TANTBE2535
Ø5.0 (in Ø4.0)		TANTBE4050
Ø6.0 (in Ø5.0)		TANTBE5060
Ø7.0 (in Ø6.0)		TANTBE6070

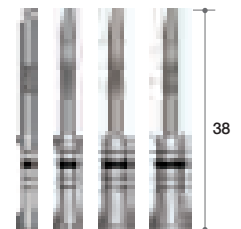
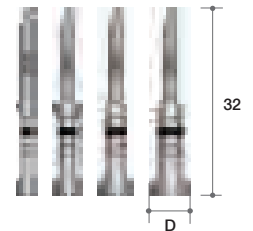

Trephine Bur Stopper

- Controls depth of trephination
- Especially useful in cases with limited available bone

Length (mm)	Ref.C
7.0	TANTSF2307
8.5	TANTSF2308
10.0	TANTSF2310
11.5	TANTSF2311

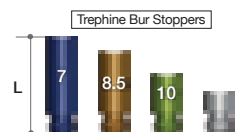
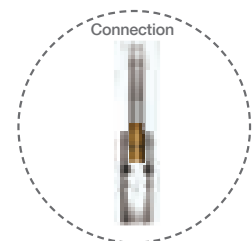

Bottom Drill

- Removes remaining bone in osteotomy socket after trephine drilling
- Laser markings of fixture sizes: 7, 8.5, 10, 11.5 & 13mm

Diameter	Type	Ref.C
Ø3.3	Short (32mm)	TCMBDS33
Ø3.8		TCMBDS38
Ø4.8		TCMBDS48
Ø5.8		TCMBDS58
Ø6.8		TCMBDS68
Ø3.3	Long (38mm)	TCMBDL33
Ø3.8		TCMBDL38
Ø4.8		TCMBDL48
Ø5.8		TCMBDL58
Ø6.8		TCMBDL68

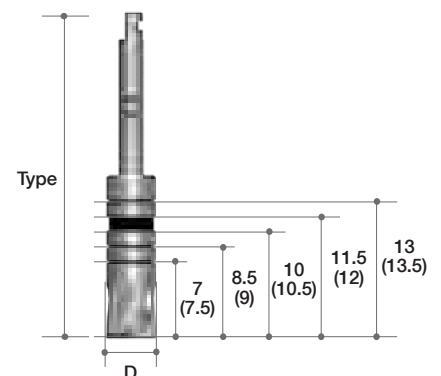

Right Angle Driver (hex 1.2)

- For engaging with cover screws, abutment screws & healing abutments
- Hex tip designed to withstand torque force of 35~45 Ncm

Length(mm)	Type	Ref.C
4	*Ultra-short	MDR120SS
10	Short	MDR120S
15	Long	MDR120L
20	*Extra Long	MDR120EL

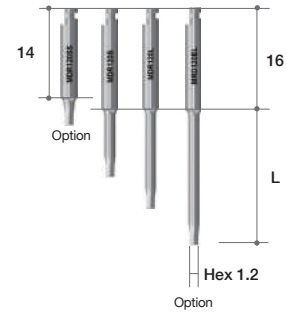

Insert Driver (hex 1.2)

- For engaging with cover screws, abutment screws & healing abutments
- Hex tip designed to withstand torque force of 35~45 Ncm

Length(mm)	Type	Ref.C
10	Short	MID120S
15	Long	MID120L

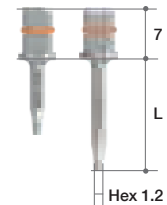

Reamer Drill & Center Pin

- For removing inner lip of cast after casting burn-out cylinders of solid abutment
- Center pins have 4 diameters according to profile diameter of solid abutment

Diameter	Type	Ref.C
Ø10.0	Reamer Drill	TANRD
Ø4.0	Center Pin	TANRDJ40
Ø4.5		TANRDJ50
Ø5.5		TANRDJ60
Ø6.5		TANRDJ70

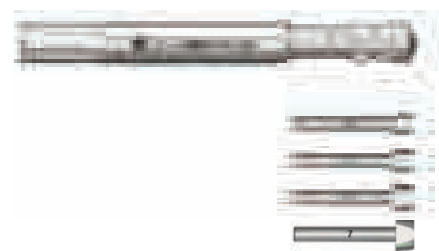

Slot Driver (Slotted type)

- For placement or removal of AnyOne Healing Abutment which has slot on top

Length(mm)	Type	Ref.C
10	Short	SDS06
15	Middle	SDM06
20	Long	SDL06

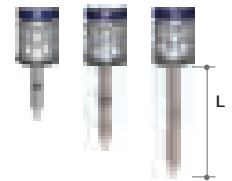

Removal Driver

Length(mm)	Type	Ref.C
21	M1.6	ARORDS16



Hand Driver (1.2 Hex)

1 2 3

4 5 6

Abutment Removal Driver

1. Use Hand Driver(1.2 Hex) to unscrew abutment screw
2. Continue to turn counter-clockwise until feeling click of disengagement
3. Push down Hand Driver once again to catch & fix abutment screw
4. Lift up Hand Driver lightly & continue to turn counter-clockwise until abutment screw engages with inner screw of abutment
5. Remove abutment screw completely from abutment
6. Insert Abutment Removal Driver & continue to turn clockwise until abutment comes out of fixture. Despite initial resistance, only simple force is needed to disconnect abutment from fixture

Digital Dentistry

I. MegaGen Digital Workflow

- Digital Equipment

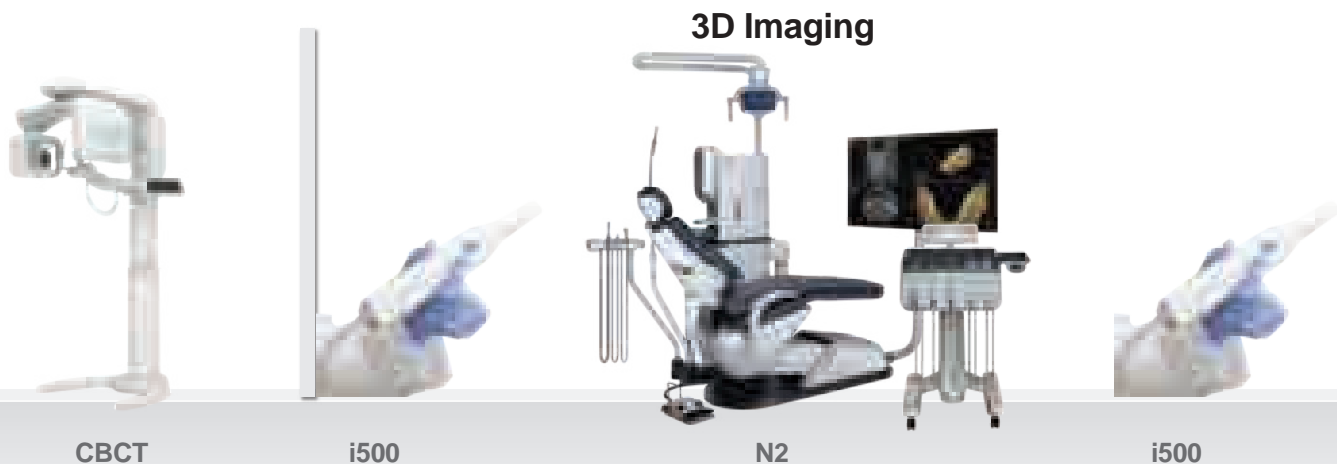

- Materials

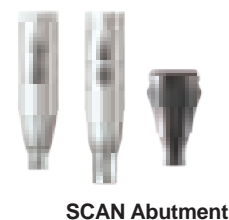

- Important for Dentists

Tx. Planning & Design



R2GATE® Premium

In-lab Equipment



Meg Printer II



BX5

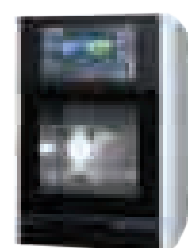

X5



Surgical KIT



R2 Package



Resin



R2 Guide™



Premilled PMMA / Ceramic



Blocks



TiGen



R2 Guide™



Blocks



Zr. Custom

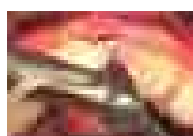

R2 Guided Surgery & ONE-DAY Implant™



Provisional



Abutment-integrated glass ceramic final crown



Abutment-integrated semi-crown



Ti-Custom



Final Crown

II. R2GATE®

Innovative diagnostic software for identifying & solving all challenges related to implant treatment

Integrating all information required for top-down implant positioning

CBCT (Dicom)

CBCT scans reveal the shape of the alveolar bone, plus the location of the mandibular neural tube and maxillary sinus, allowing implant placement planning. However, the CBCT imaging method also suffers from metal scattering and distortion, which affect the accuracy of the implant positioning.

STL (soft tissue & teeth)

R2GATE superimposes STL (3D scan of model or impression) and CBCT files to overcome the shortcomings of CBCT, while checking the relationship between proximal and antagonist teeth and the shape of the soft tissue and gingiva.

Top-Down Treatment

As the ultimate purpose of implant treatment is to restore a lost tooth, R2GATE checks the position of the final prosthesis, crown design, and relationship between proximal and antagonist teeth in order to select the ideal implant location.

Digital EYE™

Analyzing bone quality by color

While CBCT is effective for identifying the bone morphology and skeletal structure, the human eye can only distinguish 16 (6%) of the 256 black & white shades represented on a CBCT scan. Using standardized brightness levels, Digital EYE colorizes the CBCT shades to provide a bone condition analysis to determine the proper implant size, best implant position, and appropriate drilling sequence to ensure the optimal initial implant stability.

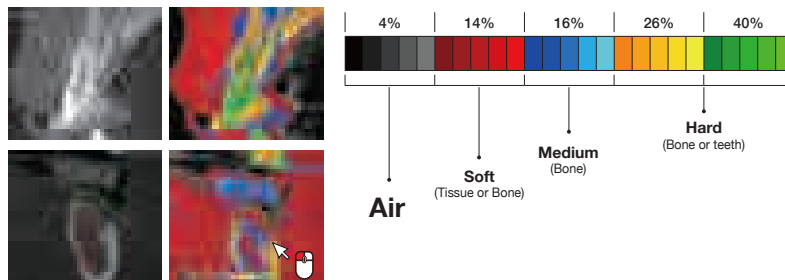

Standardized brightness

A Special Windowing Function and the Hounsfield unit scale are used to standardize the brightness levels from different CT equipment.

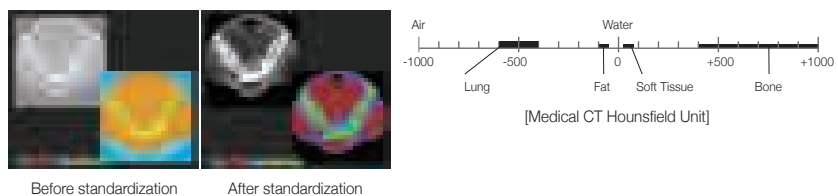

ONE-DAY Implant™

Temporary prosthesis is restored immediately after implant placement!

As the diagnostic functions of R2GATE provide predictable indications for immediate loading, a customized abutment and temporary prosthesis can be made before surgery for immediate restoration following implant placement

- After attaching fixture to handpiece carrier, place fixture using R2 GUIDE
 - a. For placement depth, align upper line of handpiece carrier with GUIDE window, see Fig. 1
 - b. For inner hex direction, align green part of handpiece carrier body part with GUIDE window, see Fig. 2

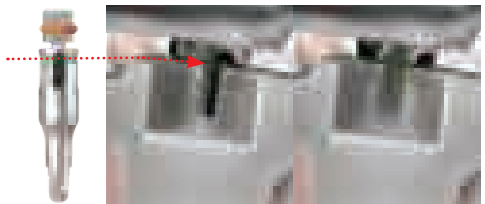

[Fig. 1]

[Fig. 2]





Immediate Loading

Recommended values for immediate loading: ITV (Initial Torque Value) $\geq 45\text{Ncm}$ + ISQ ≥ 75

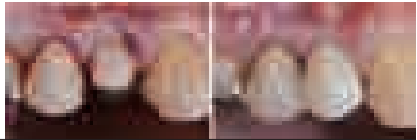

Torque Value: $> 45\text{Ncm}$ ISQ: > 75

Custom prosthetics:

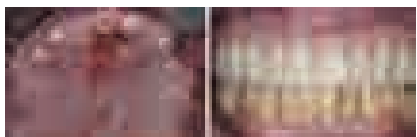
Cementation	 <ul style="list-style-type: none"> - Ready-made/custom Ti-base abutment - 3D printed or milled PMMA temporary prosthesis - Indication: single or triple bridge 	
Screw-retained	 <ul style="list-style-type: none"> - Ready-made/custom Ti-base abutment - 3D printed or milled PMMA temporary prosthesis - Indication: multi-unit bridge / non-Octa 	
Overdenture	 <ul style="list-style-type: none"> - Ready-made/custom Ti-base abutment - 3D printed or milled PMMA temporary prosthesis - Indication: edentulous 	

III. R2 GUIDE™

Most innovative implant guided surgery!
Virtual planning becomes reality

- Surgical guide is 3D-printed after final diagnosis of data
- Implant position, depth, & Octa can all be adjusted
- No need for separate metal sleeve or spoon

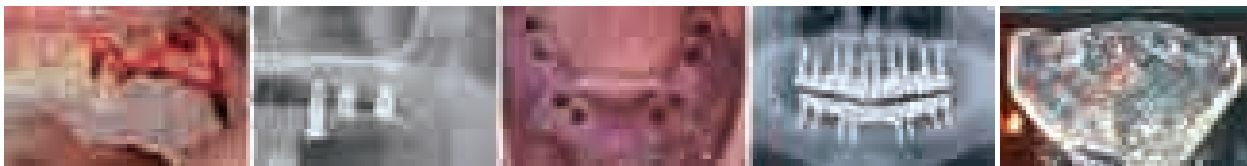

R2 GUIDE™ Option

Tooth & tissue support

R2 GUIDE is mounted on proximal teeth using Cusp Stoppers.

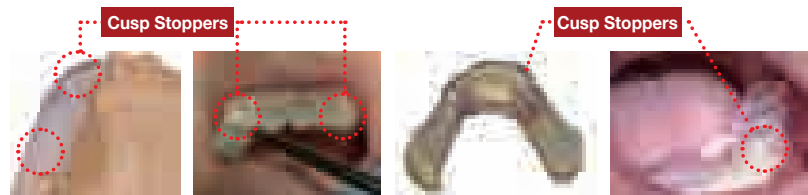

Full tissue support type (edentulous)

In edentulous cases, the R2GATE GUIDE is mounted using a putty bite and fixed in the oral cavity using specially designed anchor pins.



R2 Guided Drilling

From the initial drill to the implant carrier, everything is specially designed for guided drilling. No need for any additional sleeves or spoons, which shortens the surgery time.

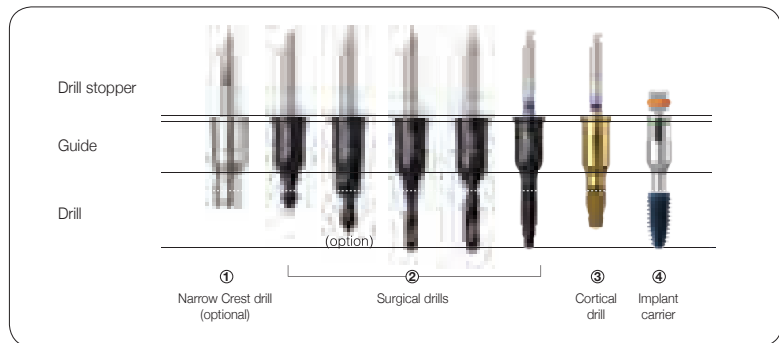

Narrow Crest Drill for narrow or steep alveolar ridge.

If a regular drill is used on a narrow or steep alveolar ridge, the drill can easily slip taking the drilling path in the wrong direction. Thus, a narrow crest drill is used first to flatten the drilling area and prevent slipping.

- Counter-clockwise: Engage drill using <100 RPM
- Clockwise: Drill using 400–600 RPM
- Start drilling sequence with initial drill
- Collect bone by separating drill body after drilling

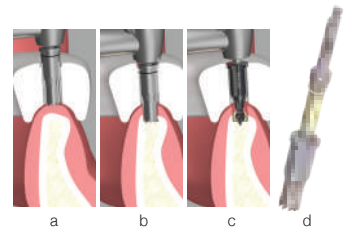

2nd Drill

This drill also works as a profiler drill to remove any excess bone above the fixture platform for a better prosthetic connection. With dense bone or high resistance during drilling, stop 2nd drilling protocol and try again right before fixture placement.

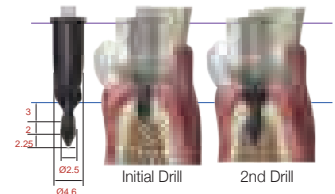

Drilling Protocol

Narrow Ø2.0 diameter drilling is very important to complete the coronal path of the drill. Especially when the guide core is short due to thick gingiva, gradual drilling to secure the fixture depth is essential for successful surgery. Eg) When placing 11.5mm fixture
 Narrow drill → initial Drill → (2nd drill) → 2.0x7 → 2.0x8.5 → 2.0x10 → 2.0x11.5 → 2.5x11.5 → 2.8x11.5 → Final drill → Cortical bone drill

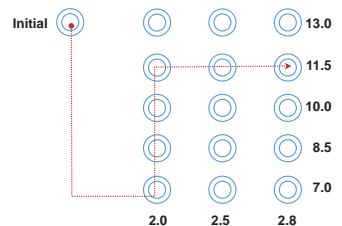

Slow Drilling with Drill Core

Before drilling, check the drill guide part is completely inserted into the drilling core of the GUIDE. Recommended RPM: 300 ~ 500 RPM.

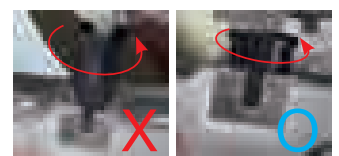

Slow UP & DOWN Motion

The recommended drilling protocol first increases the depth of the osteotomy and then widens the diameter. Slowly repeat an up & down motion until the drill stopper touches the stopper position in the GUIDE.



IV. R2 Surgical Kit

Ref.C

KAGIN3002

Contains all drills & components required for Digital Guided Surgery using R2 Guide following diagnosis using R2GATE Software
Minimally invasive surgery can achieve same results, while minimizing surgical errors

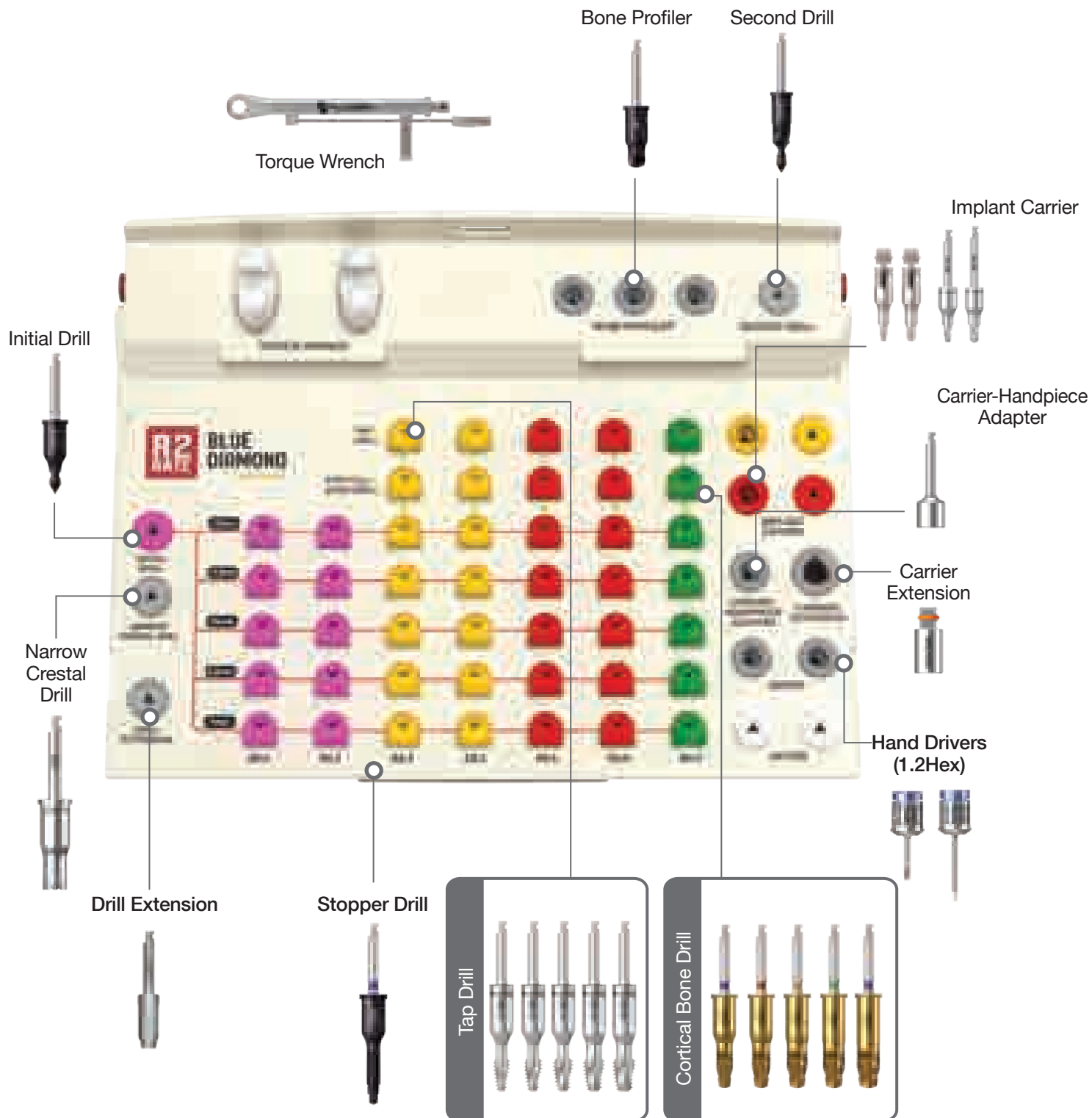

➔ Components of R2GATE Full Surgical Kit



Initial Drill

- Use for marking drilling position on bone
- Start drilling slowly after drill guide part is fully inserted into drilling core of R2GATE GUIDE™.
- Recommended drilling speed: 300 ~ 800 RPM with copious irrigation

Diameter	Guide Diameter	Length(mm)	Ref.C
Ø2.6	Ø5.0	1.0	R2ID2601

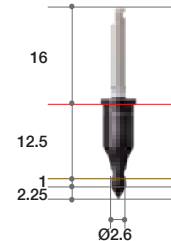

Second Drill

- Unique step – drilling (from Ø2.0 to Ø4.6) is used to flare out upper cortical bone of osteotomy
- This helps with rest of drilling procedure & abutment connection
- With hard bone, if 2nd drilling is disturbed by thick cortical bone, stop & try again before fixture placement

Diameter	Guide Diameter	Length(mm)	Ref.C
Ø2.5	Ø5.0	5.0	R2SD2505

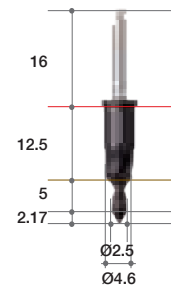

Stopper Drills

- Diameters: Ø2.0, Ø2.5, Ø2.8 for gradual enlargement of osteotomy
- Drill lengths: 7.0, 8.5, 10, 11.5, 13mm appropriate for most implant lengths
- Recommended drilling speed: 500 ~ 800 RPM with copious irrigation.

Diameter	Guide Diameter	Length(mm)	Ref.C
Ø2.0	Ø5.0	6.5	R2SD2007
		8	R2SD2008
		9.5	R2SD2010
		11	R2SD2011
		12.5	R2SD2013
Ø2.5	Ø5.0	6.5	R2SD2507
		8	R2SD2508
		9.5	R2SD2510
		11	R2SD2511
		12.5	R2SD2513
Ø2.9	Ø5.0	7	R2UD2907
		8	R2UD2908
		9.5	R2UD2910
		11	R2UD2911
		12.5	R2UD2913
Ø3.3	Ø5.0	7	R2UD3307
		8	R2UD3308
		9.5	R2UD3310
		11	R2UD3311
		12.5	R2UD3313
Ø3.6	Ø5.0	7	R2UD3607
		8	R2UD3608
		9.5	R2UD3610
		11	R2UD3611
		12.5	R2UD3613
Ø3.9	Ø5.0	7	R2UD3907
		8	R2UD3908
		9.5	R2UD3910
		11	R2UD3911
		12.5	R2UD3913
Ø4.3	Ø5.0	7	R2UD4307
		8	R2UD4308
		9.5	R2UD4310
		11	R2UD4311
		12.5	R2UD4313

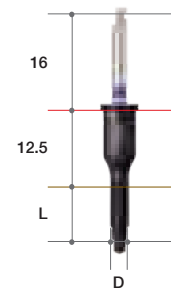

Bone Profiler

- Recommended drilling speed: 300 ~ 800 RPM

Diameter	Guide Diameter	Ref.C
Ø4.0	Ø5.0	AGBP40
Ø5.0		AGBP50
Ø6.0	Ø6.5	AGBP60

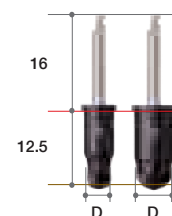

➔ Components of R2GATE Full Surgical Kit

Cortical Bone Drill

- Recommended drilling speed : 300 ~ 800 RPM

Diameter	Guide Diameter	Length(mm)	Ref.C
Ø3.6	Ø5.0	6.5	R2BDCD33
Ø4.0			R2BDCD37
Ø4.4			R2BDCD41
Ø4.7			R2BDCD44
Ø4.95			R2BDCD48

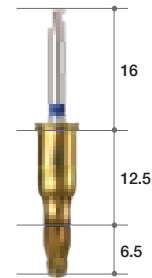

Tap Drills

- For insertion test before placing fixture
- To avoid enlarging osteotomy, select tap drill one-size smaller than osteotomy
- Recommended insertion torque & speed: 45 ~ 50Ncm, under 40 RPM.

Diameter	Guide Diameter	Length(mm)	Ref.C
Ø3.6	Ø5.0	9.5	R2TD33ARO
Ø4.0			R2TD37ARO
Ø4.4			R2TD41ARO
Ø4.7			R2TD44ARO
Ø5.0			R2TD48ARO

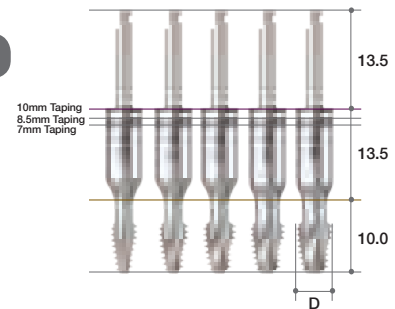

Implant Carriers

- Use to pick-up fixture from ampule, then insert into osteotomy socket & rotate clockwise 2-3 times by hand
- To tighten fixture, use Handpiece Adapter & Handpiece (Surgery Engine) (Ratchet Type)
- Recommended insertion torque: 45~50Ncm

Connection	Guide Diameter	Type	Ref.C
2.1 Octa	Ø5.0	Ratchet	ICRO2127
2.5 Octa			ICRO2530
2.1 Octa	Ø5.0	Handpiece	ICRO2127H
2.5 Octa			ICRO2530H

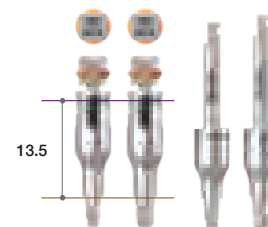

Carrier-Handpiece Adapter

- Use with handpiece for implant placement following initial delivery of fixture using implant carrier

Square	Ref.C
4.0	AGHA



Carrier Extension

- Extends length of implant carrier

Square	Ref.C
4.0	MRE400S

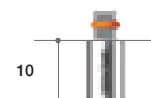

Drill Extension

- Extends drills & other handpiece instruments
- Recommended torque: <35Ncm
- Can be distorted with excessive force

Ref.C
MDE150



Hand Driver (1.2 Hex)

- For use with all cover screws, abutment screws & healing abutments
- 4 lengths for added convenience
- Directly insert into Torque Wrench without adaptor
- Hex tip can withstand 35-45Ncm of torque without distorting

Length(mm)	Type	Ref.C
5.0	*Ultra-short	TCMHDU1200
10	Short	TCMHDS1200
15	Long	TCMHDL1200
20	*Extra-long	TCMHDE1200

(*) Separate sales item.

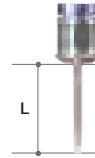

Torque Wrench (Ratchet type)

- Use for implant placement & final tightening of abutment screw
- Torque range: 15Ncm to 45Ncm

Type	Ref.C
Torque Wrench	TWSQ70

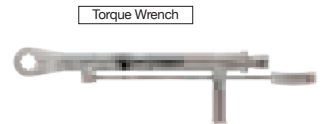

Torque Wrench & Adapter

- Use for implant placement & final tightening of abutment screw
- Torque range: 15Ncm to 45Ncm

Type	Ref.C
*Torque Wrench	MTW300A
*Torque Wrench Adapter (Handpiece)	TTA100
*Torque Wrench Adapter (Ratchet)	TTAR100

(*) Separate sales item.

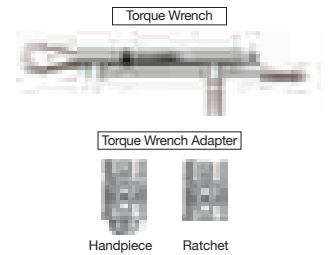

Narrow Crest Drill

- Use for angled fixture placement or to flatten bone surface of narrow ridge to prevent slipping during drilling
- Use to harvest autogenous bone if used after soft tissue
- 2-piece design: drill body & housing
- Disassemble to remove bone chips & for easy cleaning

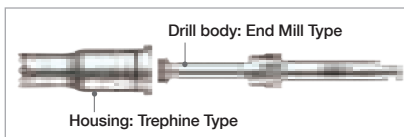

Diameter	Guide Diameter	Length(mm)	Ref.C
Ø4.0	Ø5.0	15.5(12.5/2)	NCD402

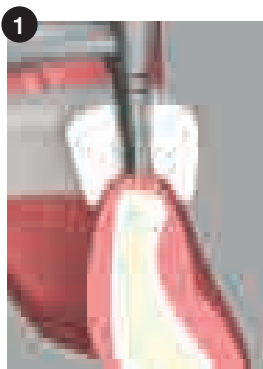
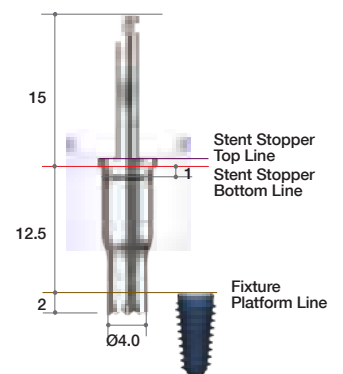

1 Set site by drilling counter-clockwise at low speed (≤ 100 rpm)

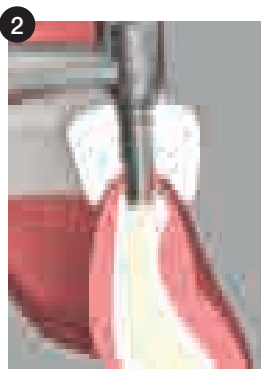

2 Start drilling clockwise (400-600rpm)

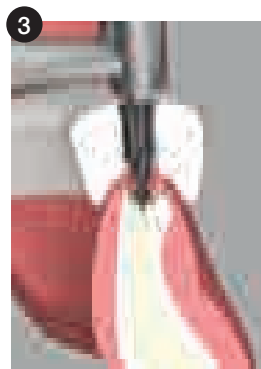

3 Once bone is flat, proceed with drilling sequence



4 Disassemble body and housing after drilling to remove bone chip. Clean and sterilize after every usage.

V. Anchor Kit

System	Ref.C
BLUEDIAMOND	KAGAS3002

In edentulous or free-end cases, R2 GUIDE™ is fixed using specially designed Anchor Pins



Required Accessory Kit

For fixing complete edentulous R2 GUIDE

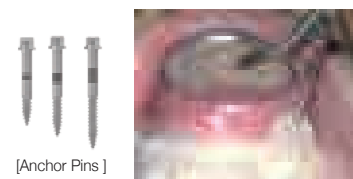

Anchor Pin:

Combine the R2 GUIDE & Putty Bite, place them in the patient's mouth, and ask the patient bite strongly. Insert an Anchor Pin into each anchor hole in the R2 GUIDE and tighten them using a screwdriver. In the case of hard bone, drill lightly with a 2.0 x 13.0mm drill for better fixation



Stent Anchor:

With a complete edentulous guide, a triangular placement of implants & stent anchors is recommended for more stability, as shown.

R2GATE provides 2 guides & stent anchors, so both guides can stay fixed when placing regular & wide implants into an edentulous jaw.

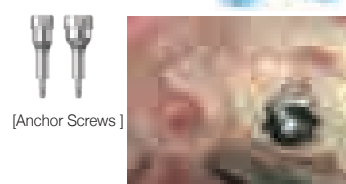
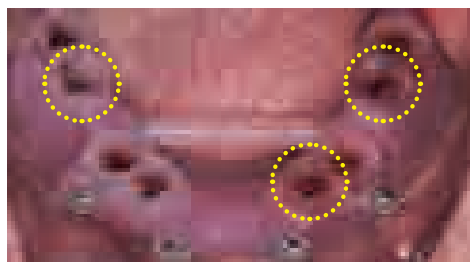

➔ Components of Anchor Kit



Anchor Pins

- Distinguish length by number of line markings
- Connect via Trox Tip

Diameter	Length(mm)	Marking Line	Ref.C
Ø2.0	5.5	1	TCMACP2015
	8.0	2	TCMACP2018
	10.5	3	TCMACP2020

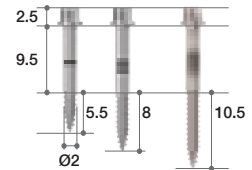

Stent Anchors

- Connect by hand or using Hand Driver

Thread	Guide Diameter	Ref.C
M1.6	Ø5.0	AGSANR16
	Ø5.0	AGSARR16
	Ø6.5	*AGSARW16

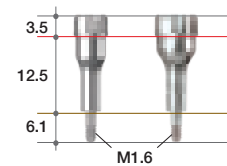

(*) Separate sales item.

Trox Tip

Length(mm)	Ref.C
80	AGTT80



Tip Driver

Ref.C
TD



VI. Digital Abutment & Prosthetic Options

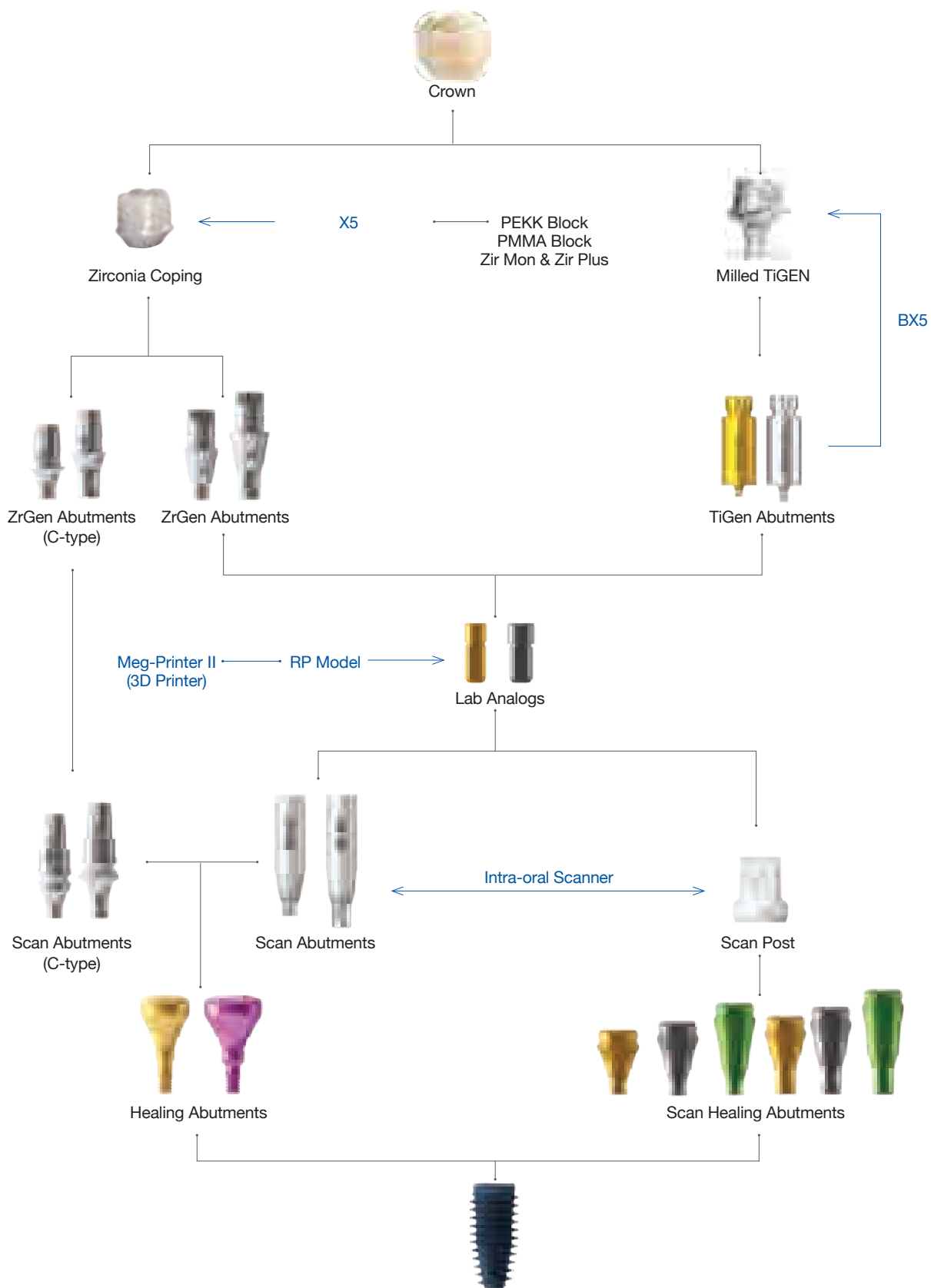

►► **ZrGEN®**

ZrGEN® is the brand name of the MegaGen titanium base that provides an esthetic outcome with a simplified dental implant prosthesis. A ZrGEN® crown & monolithic crown connected to a ZrGEN® abutment provide a strong & precise connection with an implant fixture.

ZrGEN® Varieties

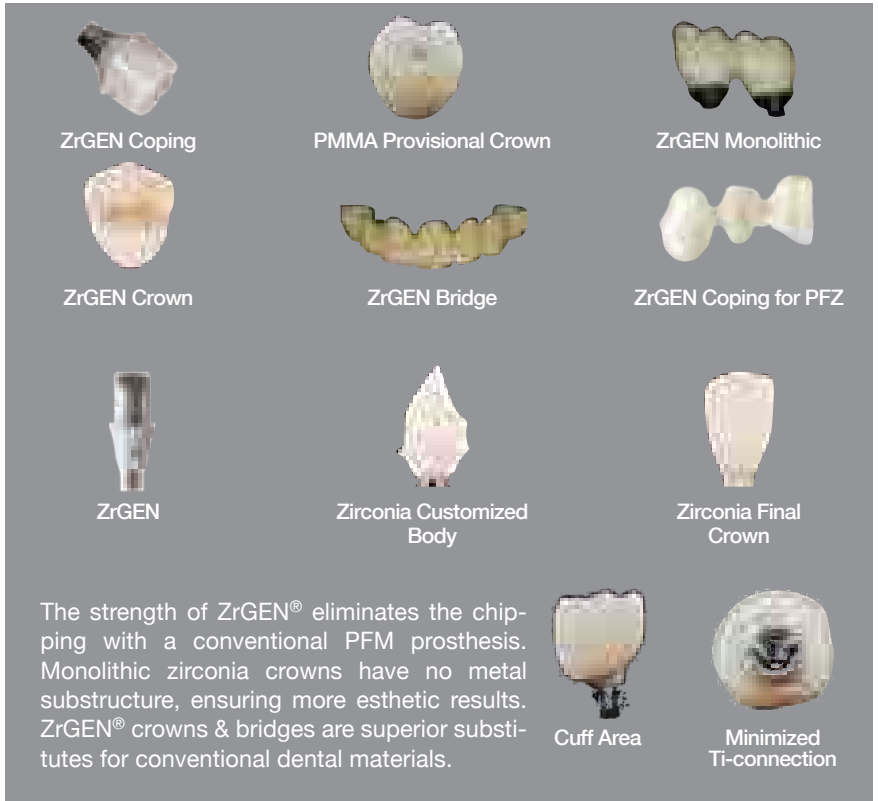

ZrGEN® Sub Structure

Clinical Applications



►► **TiGEN®**

TiGEN® is the brand name of the MegaGen titanium customized abutment that provides outstanding durability & a simplified dental implant prosthesis. The ready-made connection part provides a strong & precise connection with the implant fixture.



➔ ZrGEN Abutment options

ZrGEN Abutments

- Pre-milled
- 1set includes 10 abutments + spare abutment screw
- Supporting Dental CAD
 - 3 Shape
 - Exocad
 - Dental Wings

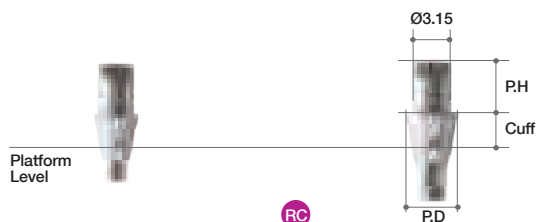

NC

Profile Diameter	Cuff Height (mm)	Post Height(mm)	Type	Ref.C
Ø4.0	0.6	4.5	Octa	AROZGN4015.MTN
	1.5			AROZGN4025.MTN
	3.0			AROZGN4035.MTN
	4.0			AROZGN4045.MTN
	0.6	6.0		AROZGN4016.MTN
	1.5			AROZGN4026.MTN
	3.0			AROZGN4036.MTN
	4.0			AROZGN4046.MTN
	0.6	8.0		AROZGN4018.MTN
	1.5			AROZGN4028.MTN
	3.0			AROZGN4038.MTN
	4.0			AROZGN4048.MTN

RC

Profile Diameter	Cuff Height (mm)	Post Height(mm)	Type	Ref.C
Ø4.5	0.6	4.5	Octa	AROZGR4515.MTN
	1.5			AROZGR4525.MTN
	3.0			AROZGR4535.MTN
	4.0			AROZGR4545.MTN
	0.6	6.0		AROZGR4516.MTN
	1.5			AROZGR4526.MTN
	3.0			AROZGR4536.MTN
	4.0			AROZGR4546.MTN
	0.6	8.0		AROZGR4518.MTN
	1.5			AROZGR4528.MTN
	3.0			AROZGR4538.MTN
	4.0			AROZGR4548.MTN

ZrGEN Abutments (C-type)

- Scan Post for Sirona Cerec users → CEREC
- In-Lab CAD software, compatible with Xive Library
 - 1set includes 10 abutments

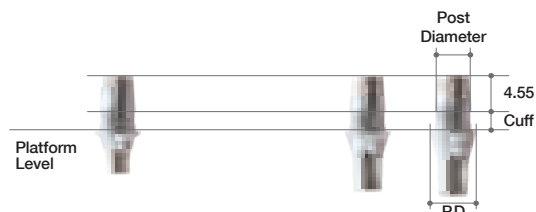

NC

Diameter	Cuff Height	Post Height	Post Size	Ref.C
Ø3.9	0.5	4.7	Small	AROCSN3405.MTN
	1.0			AROCSN3410.MTN
	2.0			AROCSN3420.MTN
Ø4.3	0.5		Small	AROCSN3805.MTN
	1.0			AROCSN3810.MTN
	2.0			AROCSN3820.MTN

RC

Diameter	Cuff Height	Post Height	Post Size	Ref.C
Ø3.9	0.5	4.7	Small	AROCSR3405.MTN
	1.0			AROCSR3410.MTN
	2.0			AROCSR3420.MTN
Ø4.3	0.5		Small	AROCSR3805.MTN
	1.0			AROCSR3810.MTN
	2.0			AROCSR3820.MTN
Ø5.5	0.5	Large	AROCLR4505.MTN	
	1.0		AROCLR4510.MTN	
	2.0		AROCLR4520.MTN	

➔ TiGEN Abutment options

TiGEN Abutments

- Pre-milled
- 1set includes 10 abutments + spare abutment screw
- Supporting Dental CAD
 - 3 Shape
 - Exocad
 - Dental Wings
- Supporting Dental CAM
 - MANIX
 - DOOWON
 - BX5

NC				RC			
Profile Diameter	Color	Type	Ref.C	Profile Diameter	Color	Type	Ref.C
Ø10	Gold	Octa	AROTGN1020.MTN	Ø10	Silver	Octa	AROTGR1020.MTN
Ø12			AROTGN1220.MTN	Ø12			AROTGR1220.MTN

TiGEN Abutments (NT type)

Launching in June 2021

- Pre-milled
- 1set includes 10 abutments + spare abutment screw
- Supporting Dental CAD
 - 3 Shape
 - Exocad
 - Dental Wings
- Supporting Dental CAM
 - NT Trading

NC				RC			
Profile Diameter	Color	Type	Ref.C	Profile Diameter	Color	Type	Ref.C
Ø10	Gold	Octa	AROTGNN1016.MTN	Ø10	Silver	Octa	AROTGRN1016.MTN
Ø12			AROTGNN1216.MTN	Ø12			AROTGRN1216.MTN

TiGEN Abutments (Medentika type)

Launching in June 2021

- Pre-milled
- 1set includes 10 abutments + spare abutment screw
- Supporting Dental CAD
 - 3 Shape
 - Exocad
 - Dental Wings
- Supporting Dental CAM
 - Medentika

NC				RC			
Profile Diameter	Color	Type	Ref.C	Profile Diameter	Color	Type	Ref.C
Ø12	Gold	Octa	AROTGNM1214.MTN	Ø12	Silver	Octa	AROTGRM1214.MTN

TiGEN Abutments (Reverse type)

Launching in June 2021

- Pre-milled
- 1set includes 10 abutments + spare abutment screw
- Supporting Dental CAD
 - 3 Shape
 - Exocad
 - Dental Wings
- Use reverse jig
 - Reverse jig types
 - BX5 / MANIX / DOOWON
 - NT Trading
 - Medentika

NC				RC			
Profile Diameter	Color	Type	Ref.C	Profile Diameter	Color	Type	Ref.C
Ø10	Gold	Octa	AROTGNR1015.MTN	Ø10	Silver	Octa	AROTGRR1015.MTN
Ø12			AROTGNR1215.MTN	Ø12			AROTGRR1215.MTN

➔ Scan Abutment options

Scan Abutments

- Abutment Screw (AROAS16B/ AROAS16) included

- For Chairside/ Labside
- Spare abutment screw included
- Supporting Dental CAD
 - 3 Shape
 - Exocad
 - Dental Wings

Profile Diameter	Height(mm)	Ref.C
Ø4.0	13	AROSAN
		AROSAR

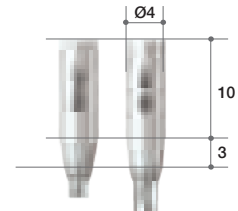

Scan Abutments (C-type)

- Abutment Screw (AROAS16B/ AROAS16) included

- Scan Post for Sirona Cerec Users → CEREC
- In-Lab CAD Software, compatible with Xive Library

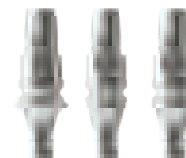
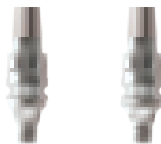

NC

Profile Diameter	Cuff Height (mm)	Post Size (mm)	Ref.C
Ø3.9	0.5	Small	AROCSS3405NT
	1.0		AROCSS3410NT
	2.0		AROCSS3420NT
Ø4.3	0.5		AROCSS3805NT
	1.0		AROCSS3810NT
	2.0		AROCSS3820NT

RC

Profile Diameter	Cuff Height (mm)	Post Size (mm)	Ref.C
Ø3.9	0.5	Small	AROCSS3405RT
	1.0		AROCSS3410RT
	2.0		AROCSS3420RT
Ø4.3	0.5		AROCSS3805RT
	1.0		AROCSS3810RT
	2.0		AROCSS3820RT
Ø5.5	0.5	Large	AROCSL4505RT
	1.0		AROCSL4510RT
	2.0		AROCSL4520RT

Scan Healing Abutments

- S.H.A. Screw included
(AROHS1604/ AROHS1605/ AROHS1607)

- Secure scan data without removing Scan Healing Abutment
- Spare abutment screw included
- Color-coded by height
- For accurate scanning, Scan Healing Abutment must be exposed at least 2.0mm from surgical site
- Select Scan Post according to diameter of Scan Healing Abutment
- Scan Post is disposable & each package includes 10

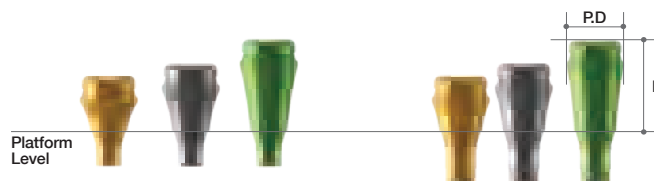

NC				RC			
Profile Diameter	Scan Post	Height (mm)	Ref.C	Profile Diameter	Scan Post	Height (mm)	Ref.C
Ø4.0	SP4007.MTN	4	AROISHN4004T	Ø4.0	SP4007.MTN	4	AROISHR4004T
		5	AROISHN4005T			5	AROISHR4005T
		7	AROISHN4007T			7	AROISHR4007T
Ø5.0	SP5007.MTN	4	AROISHN5004T	Ø5.0	SP5007.MTN	4	AROISHR5004T
		5	AROISHN5005T			5	AROISHR5005T
		7	AROISHN5007T			7	AROISHR5007T
Ø6.0	SP6007.MTN	4	AROISHN6004T	Ø6.0	SP6007.MTN	4	AROISHR6004T
		5	AROISHN6005T			5	AROISHR6005T
		7	AROISHN6007T			7	AROISHR6007T
Ø7.0	SP7007.MTN	4	AROISHN7004T	Ø7.0	SP7007.MTN	4	AROISHR7004T
		5	AROISHN7005T			5	AROISHR7005T
		7	AROISHN7007T			7	AROISHR7007T

Scan Post Carrier

Profile Diameter	Height(mm)	Ref.C
Ø4.0	19	SPC16

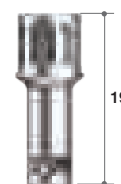

Lab Analogs

- Replaces implant in model
- Use Gold Analog for NC connection fixture
- Use Silver Analog for RC connection fixture

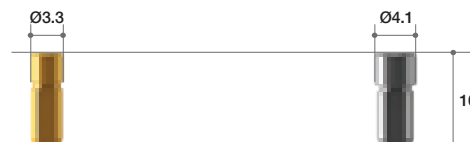

NC		RC	
Profile Diameter	Ref.C	Profile Diameter	Ref.C
Ø3.3	AROLAN	Ø4.1	AROLAR

A CUT ABOVE THE REST
BLUEDIAMOND
IMPLANT



Rev. 01

**BLUE
DIAMOND**
IMPLANT

Head Office
Gangnam Office

45, Secheon-ro 7-gil, Dasa-eup, Dalseong-gun, Daegu, Korea
MegaGen Tower, 607 Seolleung-ro, Gangnam-gu, Seoul, Korea

T. +82-1544-2285
T. +82-1566-2338

www.imegagen.com

MEGAGEN
For Lifetime Smiles