

ANYONE[®] Internal

by MEGA'GEN







Key Advantages

AnyOne[®] can be enjoyed by anyone from the beginner to the most experienced implantologist.

Simplified compatible & Single platform prosthetics
(11° Internal Hex Connection).



004 Characteristics & Advantages

004 I. Design Concept

005 II. Variety of AnyOne Fixtures

006 III. Features

008 Fixture Product

008 I. Fixture Dimension

010 II. Fixture Size

013 Cover Screw & Healing Abutment

014 Abutment & Prosthetic Options

014 I. Fixture level prosthesis

020 II. Abutment level prosthesis

020 1. Solid Abutment & Components

023 2. Octa Abutment & Components

027 3-1. Multi-unit Abutment & Components(N-Type)

035 3-2. Multi-unit Abutment & Components(S-Type)

039 4. Flat Abutment & Components

042 III. Overdenture Prosthesis

042 1. MegaGen Overdenture System

043 2. Meg-Loc Abutment & Component

046 3. Meg-Ball Abutment & Component

049 4. Meg-Magnet Abutment & Component

052 5. Meg-Rhein Abutment & Components

058 AnyOne Surgical Kit

058 I. AnyOne Internal Kit

067 II. Stopper Drill Kit

068 III. Prosthetic Kit

070 VI. Bone Profiler Kit

071 V. Optional components

076 R2GATE Full Surgical KIT

076 I.R2GATE Full Surgical Kit

082 R2GATE Universal Kit

088 Digital Material

020 I. ZrGEN

023 II. TiGEN

103 Clinical Case

Characteristics & Advantages

I. Design Concept

AnyOne® implant system was developed to be Tissue friendly, Operator friendly, and Patient friendly (T.O.P concept).

From a novice to an expert, every body can enjoy the benefits that AnyOne offers. The convenience of implant placement, the initial stability, excellent soft & hard tissue response and overall shorter treatment time are just few reasons that AnyOne will become your implant choice. Patients can expect minimally invasive surgery with less pain, shorter healing time, and a more esthetic final restoration. The AnyOne implant system truly offers a better experience and satisfaction to both the dentist and the patient.

1. Tissue friendly

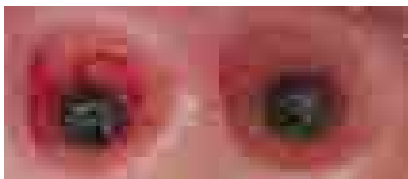

- Improved surface treatment - XPEED®
- Better crestal bone response due to stress reduction design
- Better cancellous bone response due to evenly-distributed stress
- Better soft tissue response thanks to the bio-friendly S-line shape

2. Operator friendly



- Simplified surgical protocol giving predictable initial stability
- Simplified & compatible, single platform prosthetics
- Secure osteointegration with shortened healing times
- High osseointegration

3. Patient friendly

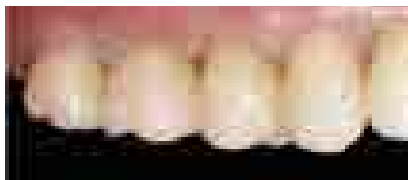

- Minimally invasive surgery
- Shorter recovery and treatment time
- Enhanced esthetic results

II. Variety of AnyOne Fixtures

AnyOne has a variety of choices.

1. Easy and convenient "Regular Thread"



For Hard Bone

Easy and Simple placement for all cases.

Ø3.5, Ø4.0, Ø4.5, Ø5.0, Ø6.0, Ø7.0

2. "Deep Thread" for stronger initial fixation



For Soft Bone

New design with extended thread gives substantially stronger initial stability for soft bone application.

Ø4.5, Ø5.5, Ø6.5, Ø7.5, Ø8.0

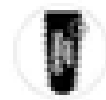

Deep Thread

3. "Special 7mm" essential for special case



For Irregular Ridge

This 'Special 7mm' fixture can be used for non-uniform bone loss case with limited available vertical dimension.

Ø4.5, Ø5.0, Ø6.0, Ø7.0

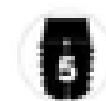

7mm Implant

III. Features

Simplified surgical protocol with predictable initial stability



Advanced fixture design allows easier drilling in any bone density while ensuring initial stability.

Diversified prosthetic options provide convenient solutions

The convenience of a single prosthetic connection for all fixture sizes with an 11 degree internal hex connection

Stress reduction on crestal bone



- Placing a fixture into the alveolar bone is easier to control due to the straight upper portion of the fixture.
- Crestal bone loss is minimized by reducing stress in the cortical bone.

KnifeThread®

Stress distribution on cancellous bone

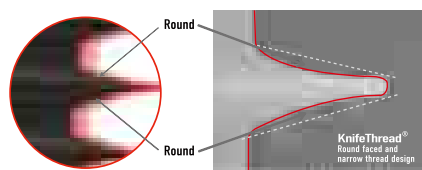

- Thanks to MegaGen's unique **KnifeThread®** and super self-tapping design, better initial stability can be attained in any compromised bone situation. The design enables bone condensing, gentle ridge expansion, maximized compressive force resistance and minimized shear force production.

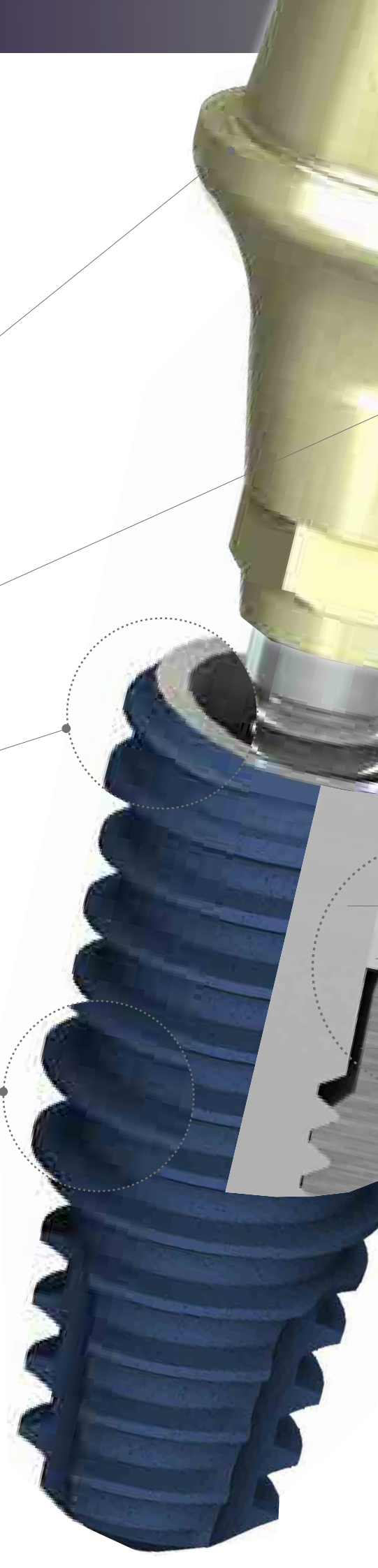



Advantage for Esthetic & CAD / CAM prosthesis

AnyOne Abutments have a sloped shoulder margin making them ideal for CAD/CAM zirconia prosthetics.

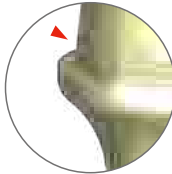

Excellent soft tissue response

The biological S-line provides seamless natural-looking and more functional emergence profile.



Higher compressive strength

- Diameter Ø4.5 can be used to molar area without a concern for fracturing.
- AnyOne fixtures have a wide parallel-wall design, making them more resistant to fracture than most of other commercialized fixtures.
- AnyOne can be used in most cases, reducing the need for GBR.



1. Wall thickness > Small size (unit : mm)

	Company A	Company B	AnyOne® Ø3.5
A	0.201	0.341	0.323
B	0.056	0.197	0.254
C	0.248	0.324	0.415

> Regular size (unit : mm)

	Company A	Company B	AnyOne® Ø4.0
A	0.296	0.476	0.431
B	0.173	0.321	0.354
C	0.369	0.466	0.515

2. Compressive strength

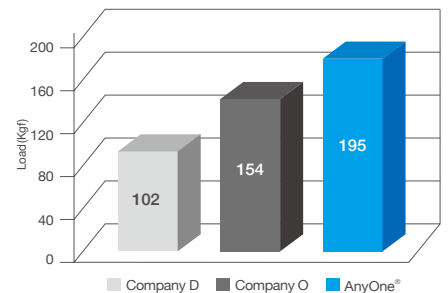

Performed compressive strength test to compare compression load of AnyOne Fixture with other companies fixture using universal testing machine -R&D center in MegaGen Implant Co.,Ltd.(2012)-

3. Fatigue test

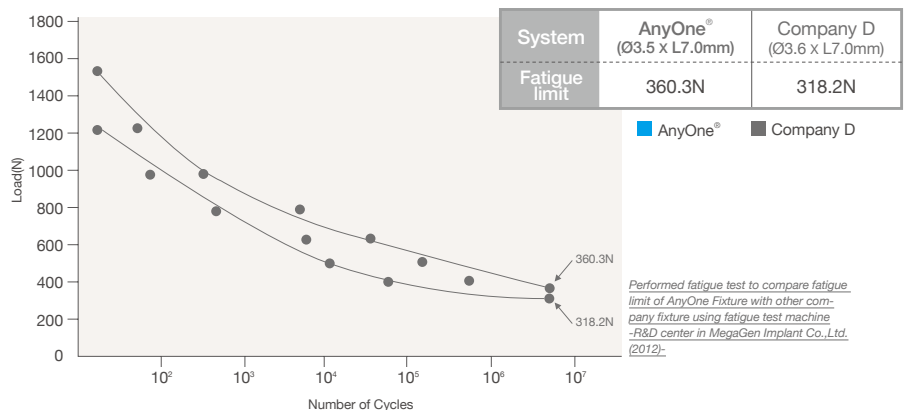

Fixture Product

I. Fixture Dimension

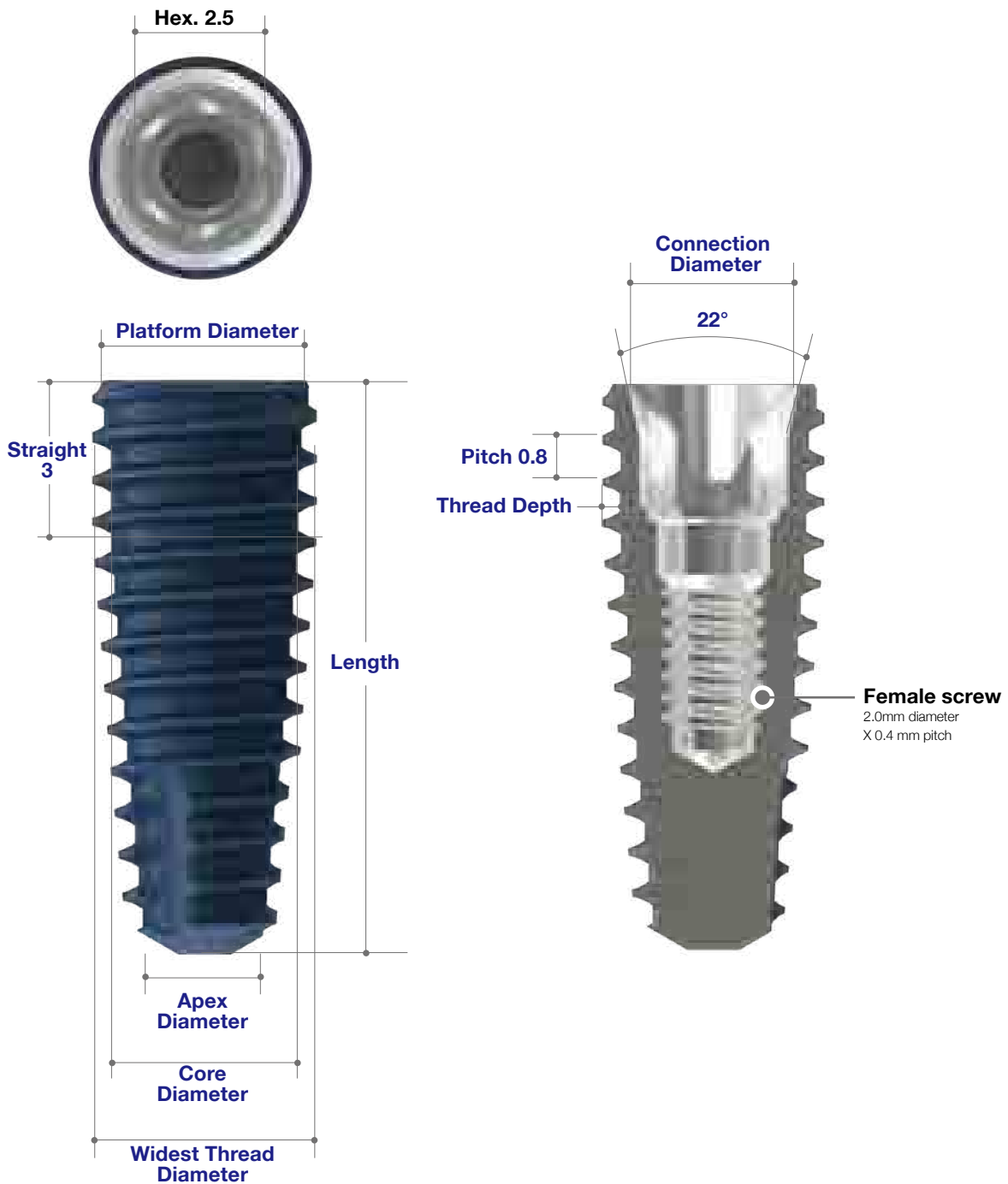

Fixture Size variation

• Normal Thread

Fixture Diameter	Widest thread Diameter	Platform Diameter	Apex Diameter	Core Diameter (Thread Depth)	Length(mm)	Connection Diameter
Ø3.5	Ø3.9	Ø3.5	Ø2.6	Ø2.8(0.25)	7.0 / 8.0 / 9.5 / 11.0 / 12.5 / 14.5	Ø3.1
Ø4.0	Ø4.3	Ø3.9	Ø3.0	Ø3.6(0.35)	7.0 / 8.0 / 9.5 / 11.0 / 12.5 / 14.5	Ø3.3
Ø4.5	Ø4.8	Ø3.9	Ø3.5	Ø4.1(0.35)	7.0 / 8.0 / 9.5 / 11.0 / 12.5 / 14.5	Ø3.3
Ø5.0	Ø5.3	Ø3.9	Ø3.6	Ø4.6(0.35)	7.0 / 8.0 / 9.5 / 11.0 / 12.5 / 14.5	Ø3.3
Ø6.0	Ø6.3	Ø3.9	Ø4.6	Ø5.6(0.35)	7.0 / 8.0 / 9.5 / 11.0 / 12.5	Ø3.3
Ø7.0	Ø7.3	Ø3.9	Ø5.7	Ø6.6(0.35)	7.0 / 8.0 / 9.5 / 11.0 / 12.5	Ø3.3

• (Excluding length 7 & 8.5)

• Deep Thread

Fixture Diameter	Widest thread Diameter	Platform Diameter	Apex Diameter	Core Diameter (Thread Depth)	Length(mm)	Connection Diameter
Ø4.5	Ø4.8	Ø3.9	Ø3.5	Ø3.6(0.6)	7.0 / 8.0 / 9.5 / 11.0 / 12.5 / 14.5	Ø3.3
Ø5.5	Ø5.8	Ø3.9	Ø4.1	Ø4.6(0.6)	7.0 / 8.0 / 9.5 / 11.0 / 12.5 / 14.5	Ø3.3
Ø6.5	Ø6.8	Ø3.9	Ø5.1	Ø5.6(0.6)	7.0 / 8.0 / 9.5 / 11.0 / 12.5 / 14.5	Ø3.3
Ø7.5	Ø7.8	Ø3.9	Ø6.2	Ø6.6(0.6)	7.0 / 8.0 / 9.5 / 11.0 / 12.5 / 14.5	Ø3.3
Ø8.0	Ø8.3	Ø3.9	Ø6.7	Ø6.6(0.85)	7.0 / 8.0 / 9.5 / 11.0 / 12.5	Ø3.3

• (Excluding length 7 & 8.5)

• Special 7mm

Fixture Diameter	Widest thread Diameter	Platform Diameter	Apex Diameter	Core Diameter (Thread Depth)	Length(mm) (Bevel H)	Connection Diameter
Ø4.5	Ø4.8	Ø3.9	Ø3.5	Ø4.1(0.3)	7(2)	Ø3.3
Ø5.0	Ø5.3	Ø3.9	Ø3.6	Ø4.6(0.3)	7(2)	Ø3.3
Ø6.0	Ø6.3	Ø3.9	Ø4.6	Ø5.6(0.3)	7(2)	Ø3.3
Ø7.0	Ø7.3	Ø3.9	Ø5.7	Ø6.6(0.3)	7(2)	Ø3.3

II. Fixture Size

Regular Thread Ø3.5

- Cover Screw(cs) included

Diameter	Length(mm)	Ref.C
Ø3.5	7.0	IF3507C
	8.5	IF3508C
	10.0	IF3510C
	11.5	IF3511C
	13.0	IF3513C
	15.0	IF3515C



Regular Thread Ø4.0

- Cover Screw(cs) included

Diameter	Length(mm)	Ref.C
Ø4.0	7.0	IF4007C
	8.5	IF4008C
	10.0	IF4010C
	11.5	IF4011C
	13.0	IF4013C
	15.0	IF4015C



Regular Thread Ø4.5

- Cover Screw(cs) included

Diameter	Length(mm)	Ref.C
Ø4.5	7.0	IF4507C
	8.5	IF4508C
	10.0	IF4510C
	11.5	IF4511C
	13.0	IF4513C
	15.0	IF4515C



Regular Thread Ø5.0

- Cover Screw(cs) included

Diameter	Length(mm)	Ref.C
Ø5.0	7.0	IF5007C
	8.5	IF5008C
	10.0	IF5010C
	11.5	IF5011C
	13.0	IF5013C
	15.0	IF5015C



Regular Thread Ø6.0

- Cover Screw(cs) included

Diameter	Length(mm)	Ref.C
Ø6.0	7.0	IF6007C
	8.5	IF6008C
	10.0	IF6010C
	11.5	IF6011C
	13.0	IF6013C

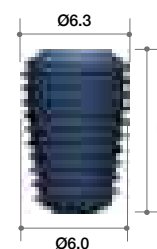

Regular Thread Ø7.0

- Cover Screw(cs) included

Diameter	Length(mm)	Ref.C
Ø7.0	7.0	IF7007C
	8.5	IF7008C
	10.0	IF7010C
	11.5	IF7011C
	13.0	IF7013C

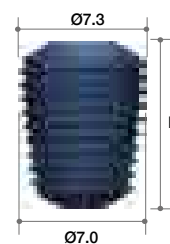

Deep Thread Ø4.5

- Cover Screw(cs) included

Diameter	Length(mm)	Ref.C
Ø4.5	7.0	IF4507DC
	8.5	IF4508DC
	10.0	IF4510DC
	11.5	IF4511DC
	13.0	IF4513DC
	15.0	IF4515DC

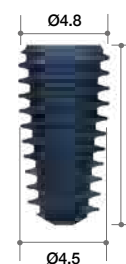

Deep Thread Ø5.5

- Cover Screw(cs) included

Diameter	Length(mm)	Ref.C
Ø5.5	7.0	IF5507DC
	8.5	IF5508DC
	10.0	IF5510DC
	11.5	IF5511DC
	13.0	IF5513DC
	15.0	IF5515DC

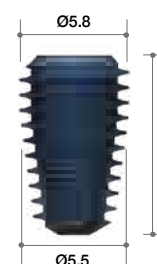

➔ Fixture Size

Deep Thread Ø6.5

- Cover Screw(cs) included

Diameter	Length(mm)	Ref.C
Ø6.5	7.0	IF6507DC
	8.5	IF6508DC
	10.0	IF6510DC
	11.5	IF6511DC
	13.0	IF6513DC
	15.0	IF6515DC

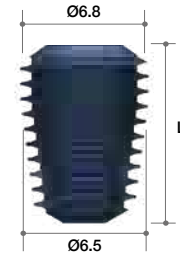

Deep Thread Ø7.5

- Cover Screw(cs) included

Diameter	Length(mm)	Ref.C
Ø7.5	7.0	IF7507DC
	8.5	IF7508DC
	10.0	IF7510DC
	11.5	IF7511DC
	13.0	IF7513DC
	15.0	IF7515DC

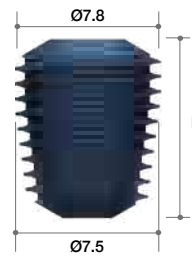

Deep Thread Ø8.0

- Cover Screw(cs) included

Diameter	Length(mm)	Ref.C
Ø8.0	7.0	IF8007DC
	8.5	IF8008DC
	10.0	IF8010DC
	11.5	IF8011DC
	13.0	IF8013DC

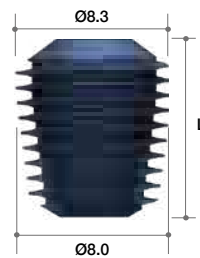

Special Length

- Cover Screw(cs) included

Diameter(mm)	Length(mm)	Ref.C
Ø4.5	7.0	IF4507SC
Ø5.0		IF5007SC
Ø6.0		IF6007SC
Ø7.0		IF7007SC

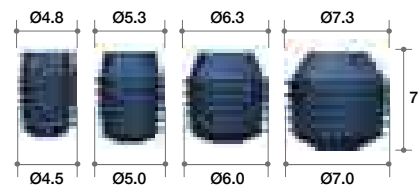

Cover Screw & Healing Abutment

Cover Screw

- Used for two stage surgical protocol.
- Protects the inner portion and platform of the fixture after placing.
- Uses Hand Driver (1.2 Hex).
- Recommend torque : by hand (5 - 8Ncm)
- Aoucs5005-Used for Ø3.5/Ø4.0/Ø4.5 fixture
- Aoucs6005-Used for Ø5.0 fixture

Profile Diameter	Height (mm)	Color	Ref.C
Ø3.5	0.5	Magenta	CS
Ø3.7	1.0	Magenta	CS1
Ø4.1	2.0	Magenta	CS2
Ø5.0	0.5	Gold	AOUCS5005
Ø6.0	0.5	Magenta	AOUCS6005

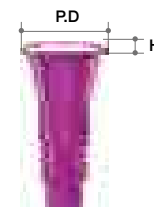

Healing Abutment

- Creates the emergence profile of the gingival tissue during healing.
- Uses Hand Driver (1.2 Hex).
- Recommend torque : by hand (5 - 8Ncm)

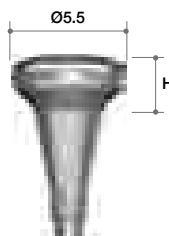

Diameter(mm)	Height(mm)	Ref.C
Ø4.0	2.5	HA4025
	3.0	HA4030
	4.0	HA4040
	5.0	HA4050
	6.0	HA4060
	7.0	HA4070
	8.0	HA4080
Ø4.5	9.0	HA4090
	2.5	HA4525
	3.0	HA4530
	4.0	HA4540
	5.0	HA4550
	6.0	HA4560
	7.0	HA4570
Ø5.5	8.0	HA4580
	9.0	HA4590
	3.0	HA5530
	4.0	HA5540
	5.0	HA5550
	6.0	HA5560
	7.0	HA5570
Ø5.0	8.0	HA5580
	9.0	HA5590

Diameter(mm)	Height(mm)	Ref.C
Ø6.5	3.0	HA6530
	4.0	HA6540
	5.0	HA6550
	6.0	HA6560
	7.0	HA6570
	8.0	HA6580
	9.0	HA6590
Ø7.5	4.0	HA7540
	5.0	HA7550
	6.0	HA7560
	7.0	HA7570
	8.0	HA7580
Ø8.5	9.0	HA7590
	4.0	HA8540
	5.0	HA8550
	6.0	HA8560
	7.0	HA8570
Ø9.5	8.0	HA8580
	9.0	HA8590
	4.0	HA9540
	5.0	HA9550
	6.0	HA9560
	7.0	HA9570
Ø8.0	8.0	HA9580
	9.0	HA9590

Abutment & Prosthetic Options

I. Fixture Level Prosthesis

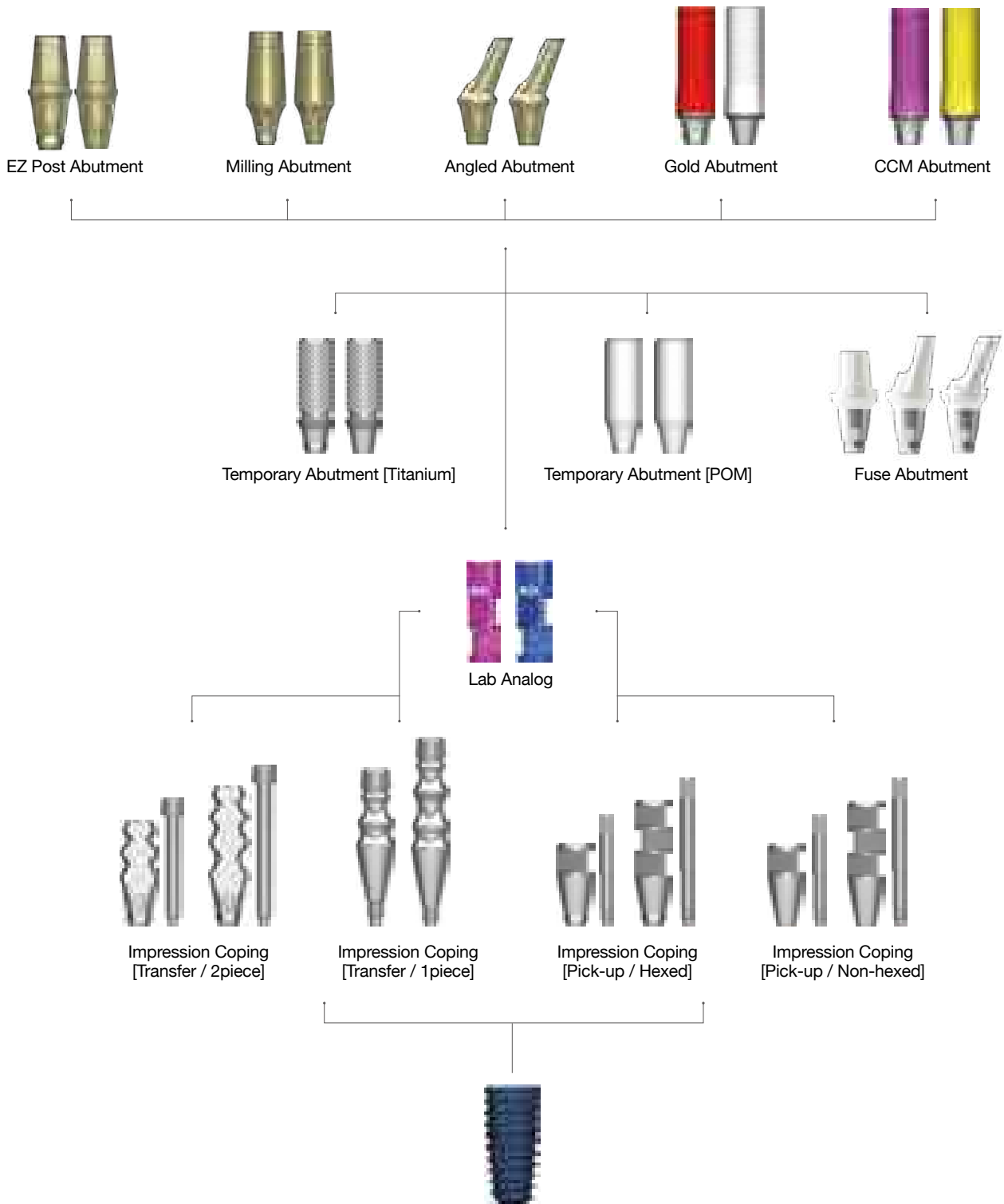

➔ Abutment Options (Continued)

Impression Coping (Transfer type)

- Guide Pin (GPT12H / GPT12 / GPT16H / GPT16) included in two piece type
- Diameters correspond to Healing Abutment diameters.
- Available in one piece (non-hex) or two piece (hex) and two heights.
- Used for Closed Tray (Transfer) technique.
- Impression Coping design ensures easy and accurate transfer of fixture position.
- Flat surface of Impression Coping aligns with the flat of the hex within the fixture.
- Transfer Impression Coping Driver and Hand Driver (1.2Hex) should be used to ensure Impression Coping is properly tightened.



Transfer Impression Coping Driver

Profile Diameter	Height (mm)	Type	Ref.C	Ref.C (1.2 Hex)	
Ø4.0	12.0	2piece	IT4012HT	IT4012HHT	
	16.0		IT4016HT	IT4016HHT	
Ø4.5	12.0		IT4512HT	IT4512HHT	
	16.0		IT4516HT	IT4516HHT	
Ø5.5	12.0		IT5512HT	IT5512HHT	
	16.0		IT5516HT	IT5516HHT	
Ø6.5	12.0		IT6512HT	IT6512HHT	
	16.0		IT6516HT	IT6516HHT	
Ø4.0	12.0		1piece	IT4012N	IT4012NH
	16.0			IT4016N	IT4016NH
Ø4.5	12.0			IT4512N	IT4512NH
	16.0			IT4516N	IT4516NH
Ø5.5	12.0	IT5512N		IT5512NH	
	16.0	IT5516N		IT5516NH	
Ø6.5	12.0	IT6512N		IT6512NH	
	16.0	IT6516N		IT6516NH	

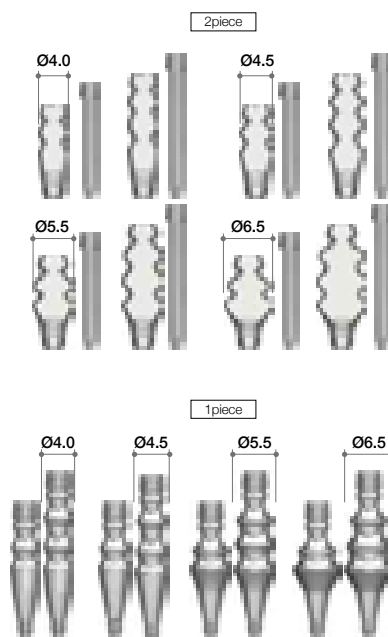

Impression Coping (Pick-up type)

- Guide Pin (GPP07 / GPP12 / GPP16) included
- Used for open tray technique. Most beneficial for multiple fixtures that will be splinted together.
- Square body design ensures stability within the impression and accurate transfer of fixture position.

Profile Diameter	Height(mm)	Type	Ref.C	
Ø4.0	12.0	Hex	IP4012HT	
	16.0		IP4016HT	
Ø4.5	7.0		IP4507HT	
	12.0		IP4512HT	
Ø5.5	7.0		IP5507HT	
	12.0		IP5512HT	
Ø6.5	7.0		IP6507HT	
	12.0		IP6512HT	
Ø4.0	12.0		Non-Hex	IP4012NT
	16.0			IP4016NT
Ø4.5	7.0			IP4507NT
	12.0			IP4512NT
Ø5.5	7.0	IP5507NT		
	12.0	IP5512NT		
Ø6.5	7.0	IP6507NT		
	12.0	IP6512NT		

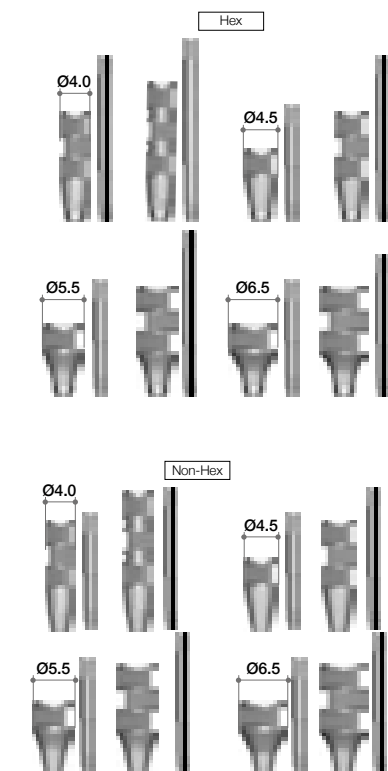

➔ Abutment Options (Continued)

Lab Analog

- Replicates the fixture.
- Magenta analog for Ø3.5 fixture.
- Blue analog for all fixture sizes for Ø4.0~Ø8.0.

Type	Color	Ref.C
Small	Magenta	LA350H
Regular & Wide	Blue	LA400H



Temporary Abutment (Titanium)

- Abutment Screw(AS20) included

- For making provisional restoration.
- Available in both hex and non-hex.
- Grooved surface on abutment post allows for better retention of resin or wax.
- Recommend torque : 25Ncm

Profile Diameter	Height(mm)	Type	Ref.C
Ø4.5	11.0	Hex	TA4511HT
		Non-Hex	TA4511NT

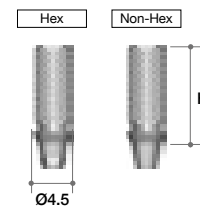

Temporary Abutment (POM)

- Abutment Screw(AS20) included

- For making chairside provisionals for the aesthetic zone.
- Especially useful for immediate placement after extraction.
- Available in both hex and non-hex.
- Recommend torque : 25Ncm

Profile Diameter	Height(mm)	Type	Ref.C
Ø4.5	11.0	Hex	TA4511HPT
		Non-Hex	TA4511NPT

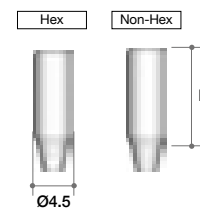

Fuse Abutment

- Abutment Screw(AS20)+Fuse cap included.

- For the design concept and rationale of the Fuse Abutment
- Recommend torque : 25Ncm

Diameter	C:H (mm)	P:H (mm)	Type	Ref.C
Ø5.5	4	5.5	Straight	AOFAP5545P
Ø4.5		7	15°	AOFAA5415P
		7	25°	AOFAP5425P

NEW : 4mm cuff height available
 → Adequate for deeply placed implants or thick gingival cases

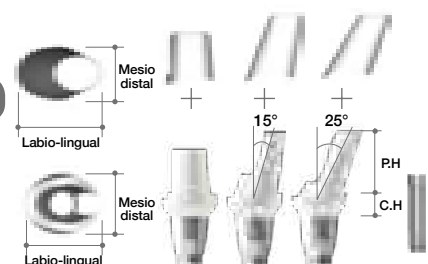

EZ Post Abutment

- Abutment Screw(AS20) included

- Cement retained restoration
- Post Height : 4.0, 5.5mm
- Profile Diameter : Ø4.5, Ø5.5, Ø6.5
- Cuff Height : 1.5, 2.5, 3.5, 4.5, 5.5mm
- Cement retained restoration
- Anodizing to ensure excellent aesthetics under the tissue. Biological S-line provides a seamless natural-looking and more functional emergence profile.
- Post Height : 4.0, 5.5mm
- Non-Hex Abutments do not provide anti-rotation and are contra-indicated for single unit restorations.
- Recommend torque : 35Ncm

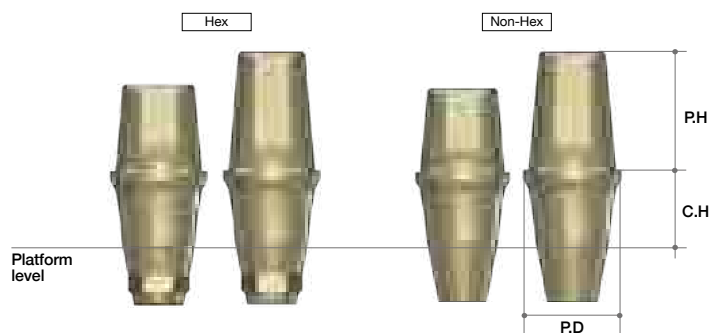

Profile Diameter	Cuff Height(mm)	Post Height(mm)	Type	Ref.C
Ø4.5	1.0	4.0	Hex	EP4511HT
	1.5			EP4514HT
	2.5			EP4524HT
	3.5			EP4534HT
	4.5			EP4544HT
	5.5	EP4554HT		
	1.0	5.5		EP4510HT
	1.5			EP4515HT
	2.5			EP4525HT
	3.5			EP4535HT
	4.5			EP4545HT
	5.5	EP4555HT		
	1.5	7.0		EP4517HT
	2.5			EP4527HT
	3.5			EP4537HT
4.5	EP4547HT			
5.5	EP4557HT			
Ø5.5	1.5	4.0	Hex	EP5514HT
	2.5			EP5524HT
	3.5			EP5534HT
	4.5			EP5544HT
	5.5			EP5554HT
	1.5	5.5		EP5515HT
	2.5			EP5525HT
	3.5			EP5535HT
	4.5			EP5545HT
	5.5			EP5555HT
	1.5	7.0		EP5517HT
	2.5			EP5527HT
	3.5			EP5537HT
	4.5			EP5547HT
	5.5			EP5557HT
Ø6.5	1.5	4.0	Hex	EP6514HT
	2.5			EP6524HT
	3.5			EP6534HT
	4.5			EP6544HT
	5.5			EP6554HT
	1.5	5.5		EP6515HT
	2.5			EP6525HT
	3.5			EP6535HT
	4.5			EP6545HT
	5.5			EP6555HT
	1.5	7.0		EP6157HT
	2.5			EP6527HT
	3.5			EP6537HT
	4.5			EP6547HT
	5.5			EP6557HT
Ø4.5	1.0	4.0	Non-Hex	EP4511NT
	1.5			EP4514NT
	2.5			EP4524NT
	3.5			EP4534NT
	4.5			EP4544NT
	5.5	EP4554NT		
	1.0	5.5		EP4510NT
	1.5			EP4515NT
	2.5			EP4525NT
	3.5			EP4535NT
	4.5			EP4545NT
	5.5	EP4555NT		
	1.5	7.0		EP4517NT
	2.5			EP4527NT
	3.5			EP4537NT
4.5	EP4547NT			
5.5	EP4557NT			
Ø5.5	1.5	4.0	Non-Hex	EP5514NT
	2.5			EP5524NT
	3.5			EP5534NT
	4.5			EP5544NT
	5.5			EP5554NT
	1.5	5.5		EP5515NT
	2.5			EP5525NT
	3.5			EP5535NT
	4.5			EP5545NT
	5.5			EP5555NT
	1.5	7.0		EP5517NT
	2.5			EP5527NT
	3.5			EP5537NT
	4.5			EP5547NT
	5.5			EP5557NT
Ø6.5	1.5	4.0	Non-Hex	EP6514NT
	2.5			EP6524NT
	3.5			EP6534NT
	4.5			EP6544NT
	5.5			EP6554NT
	1.5	5.5		EP6515NT
	2.5			EP6525NT
	3.5			EP6535NT
	4.5			EP6545NT
	5.5			EP6555NT
	1.5	7.0		EP6157NT
	2.5			EP6527NT
	3.5			EP6537NT
	4.5			EP6547NT
	5.5			EP6557NT

➔ Abutment Options

Milling Abutment

- Abutment Screw(AS20) included
- Used for abutment design by customized milling.
- Available in both hex and Non-Hex, in four diameters (Ø4.0, Ø4.5, Ø5.5 & Ø6.5) and in various cuff heights.
- Recommend torque : 35Ncm

Profile Diameter	Cuff Height(mm)	Post Height(mm)	Type	Ref.C	
Ø4.0	1.5	9.0	Hex	MA4015HT	
Ø4.5	2.0			MA4520HT	
Ø5.5	2.0			MA5520HT	
	4.0			MA5540HT	
Ø6.5	2.5			MA6525HT	
	4.0			MA6540HT	
Ø4.0	1.5			Non-Hex	MA4015NT
Ø4.5	2.0				MA4520NT
Ø5.5	2.0		MA5520NT		
	4.0		MA5540NT		
Ø6.5	2.5		MA6525NT		
	4.0		MA6540NT		

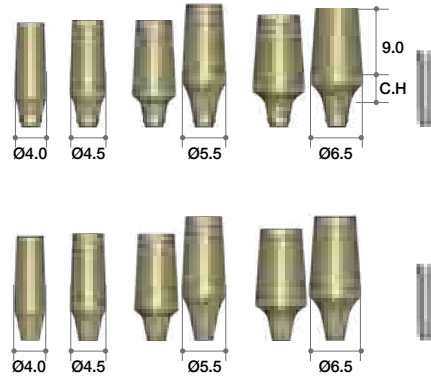

Milling Abutment Type II (BOPT Abutment)

- AnyOne Internal : Abutment Screw (AS20) included.
- Long post enables easier customization from milling.
- Recommend torque : 35Ncm

Profile Diameter	Cuff Height(mm)	Post Height(mm)	Type	Ref.C
Ø4.0	1.0	19	Hex	AOBOT4019HT
			Non-Hex	AOBOT4019NT

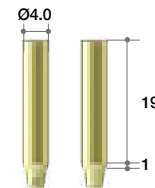

Angled Abutment

- Abutment Screw(AS20) included
- 2 different angulations (15°, 25°)
- Available in two diameters (Ø4.5 & Ø5.5) and in two cuff heights (2.5 & 4.5mm).
- Height of minimized screw head helps to prevent milling problems.
- Profile Diameters : Ø4.5, Ø5.5
- Cuff Height : 2.5, 4.5mm
- Recommend torque : 35Ncm

Profile Diameter	Cuff Height (mm)	Post Height (mm)	Type	Angle	Ref.C	
Ø4.5	2.5	7.0	Hex	15°	AA4215HT	
				25°	AA4225HT	
	4.5			15°	AA4415HT	
				25°	AA4425HT	
Ø5.5	2.5			Non-Hex	15°	AA5215HT
					25°	AA5225HT
	4.5				15°	AA5415HT
					25°	AA5425HT
Ø4.5	2.5		Non-Hex		15°	AA4215NT
					25°	AA4225NT
	4.5				15°	AA4415NT
					25°	AA4425NT
Ø5.5	2.5	Non-Hex		15°	AA5215NT	
				25°	AA5225NT	
	4.5			15°	AA5415NT	
				25°	AA5425NT	
Ø4.5	2.5		Hex-E	15°	AA4215ET	
				25°	AA4225ET	
	4.5			15°	AA4415ET	
				25°	AA4425ET	
Ø5.5	2.5	Hex-E		15°	AA5215ET	
				25°	AA5225ET	
	4.5			15°	AA5415ET	
				25°	AA5425ET	

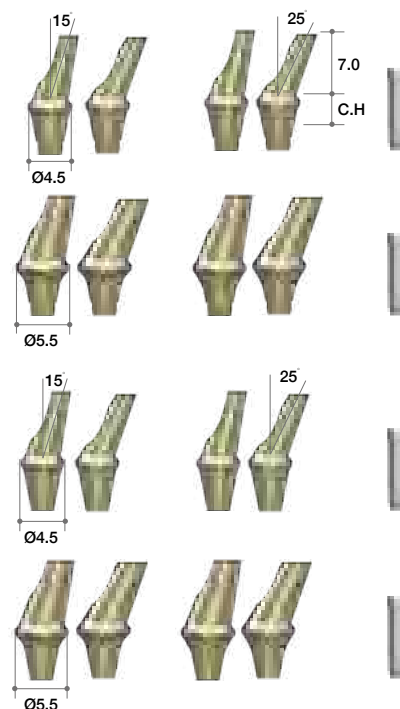

Gold Abutment

- Abutment Screw(AS20) included

- For fabrication of customized abutment for either screw or cement retained restorations.
- Available in both hex (red) and non-hex (white)
- Melting point of gold alloy : 1063°C
- Threaded sleeves allow for better retention of resin or wax.
- Recommend torque : 30Ncm

Profile Diameter	Cuff Height (mm)	Post Height (mm)	Type	Ref.C
Ø4.5	1.0	11.0	Hex	GA4515HT
			Non-Hex	GA4515NT

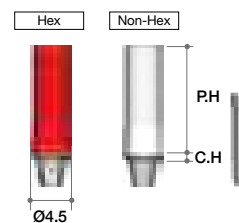

CCM Abutment

- Abutment Screw(AS20) included

- Useful to make a customized abutment in difficult situations.
- Can be casted with non-precious alloys(Ni-Cr, Cr-Co alloys).
- Non-precious melting temperature : Depend on Manufacturer
- Threaded sleeves for convenient Resin / Wax-up.
- Melting temperature of CCM : 1300~1400°C
- Recommend torque : 35Ncm

Profile Diameter	Cuff Height (mm)	Post Height (mm)	Type	Ref.C
Ø4.5	1.0	11.0	Hex	CA4515HT
			Non-Hex	CA4515NT

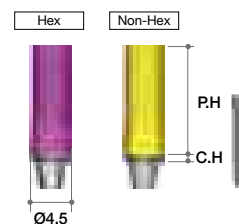

II. Abutment Level Prosthesis

1. Solid Abutment & Components

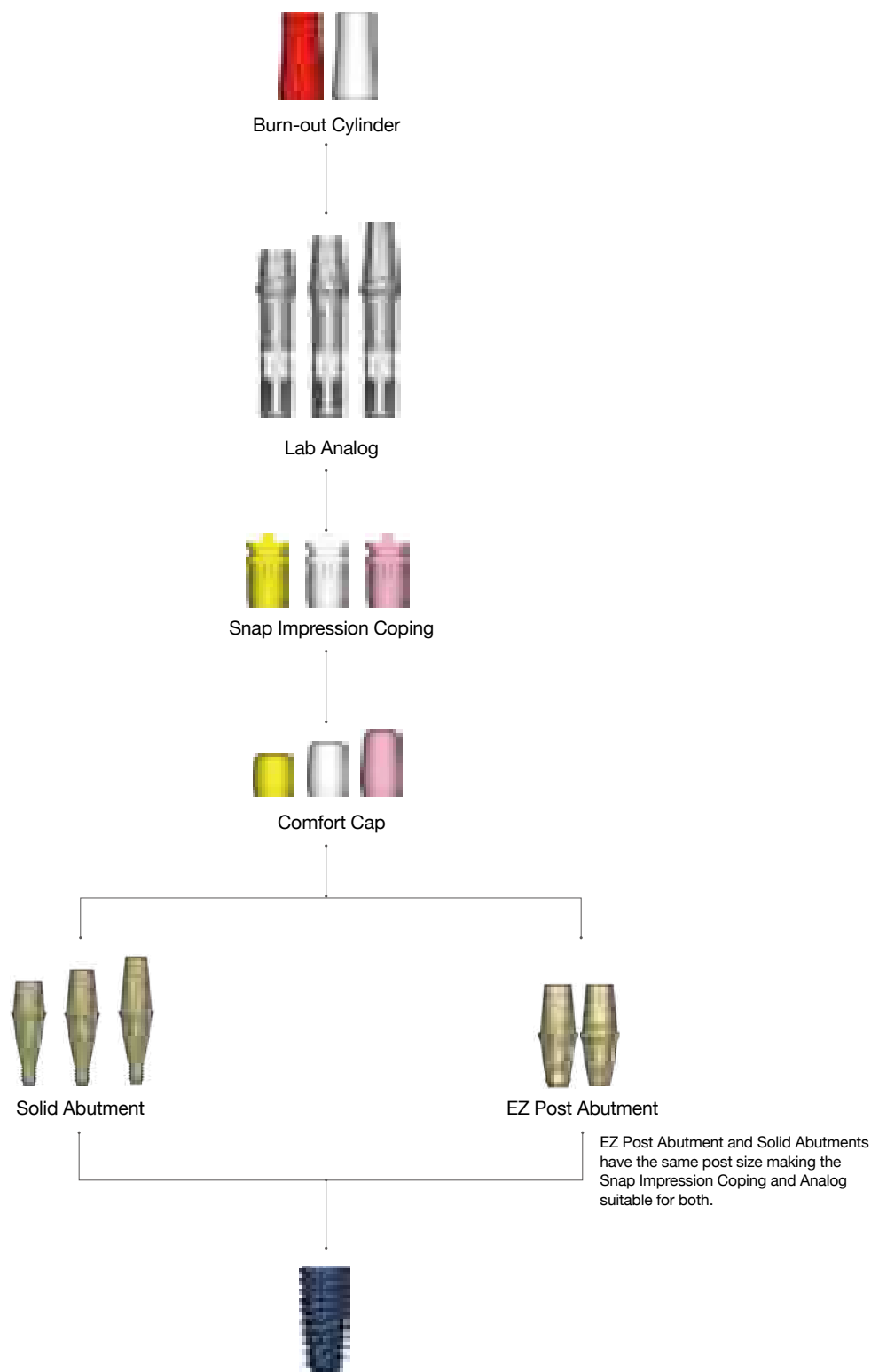

➔ Solid Abutment & Lab Analog

Solid Abutment

- Cement retained restoration only.
- Solid Abutment should be placed into patient's mouth before taking impression.
- Should be tightened with Solid Driver and Hand Driver.
- Recommend Torque : 35Ncm
- Profile Diameter : Ø4.0, Ø4.5, Ø5.5, Ø6.5
- Cuff Height : 1.5, 2.5, 3.5, 4.5, 5.5mm
- Post Height : 4.0, 5.5, 7.0mm

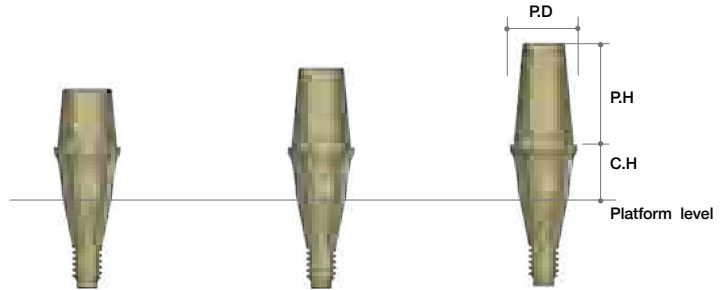

Profile Diameter	Cuff Height(mm)	Post Height(mm)	Ref.C
Ø4.0	1.0	4.0	SL40104
	1.5		SL40154
	2.5		SL40254
	3.5		SL40354
	4.5		SL40454
	5.5	SL40554	
	1.0	5.5	SL40105
	1.5		SL40155
	2.5		SL40255
	3.5		SL40355
	4.5		SL40455
	5.5	SL40555	
	1.0	7.0	SL40107
	1.5		SL40157
	2.5		SL40257
3.5	SL40357		
4.5	SL40457		
5.5	SL40557		
Ø4.5	1.0	4.0	SL45104
	1.5		SL45154
	2.5		SL45254
	3.5		SL45354
	4.5		SL45454
	5.5	SL45554	
	1.0	5.5	SL45105
	1.5		SL45155
	2.5		SL45255
	3.5		SL45355
	4.5		SL45455
	5.5	SL45555	
	1.0	7.0	SL45107
	1.5		SL45157
	2.5		SL45257
3.5	SL45357		
4.5	SL45457		
5.5	SL45557		

Profile Diameter	Cuff Height(mm)	Post Height(mm)	Ref.C
Ø5.5	1.5	4.0	SL55154
	2.5		SL55254
	3.5		SL55354
	4.5		SL55454
	5.5		SL55554
	1.5	5.5	SL55155
	2.5		SL55255
	3.5		SL55355
	4.5		SL55455
	5.5		SL55555
1.5	7.0	SL55157	
2.5		SL55257	
3.5		SL55357	
4.5		SL55457	
5.5		SL55557	
Ø6.5	1.5	4.0	SL65154
	2.5		SL65254
	3.5		SL65354
	4.5		SL65454
	5.5		SL65554
	1.5	5.5	SL65155
	2.5		SL65255
	3.5		SL65355
	4.5		SL65455
	5.5		SL65555
1.5	7.0	SL65157	
2.5		SL65257	
3.5		SL65357	
4.5		SL65457	
5.5		SL65557	

Lab Analog

- Used for Solid Abutment
- Used only if Solid Abutment was not modified.

Profile Diameter	Height(mm)	Ref.C
Ø4.0	4.0	LA4040P
	5.5	LA4055P
	7.0	LA4070P
Ø4.5	4.0	LA4540P
	5.5	LA4555P
	7.0	LA4570P
Ø5.5	4.0	LA5540P
	5.5	LA5555P
	7.0	LA5570P
Ø6.5	4.0	LA6540P
	5.5	LA6555P
	7.0	LA6570P

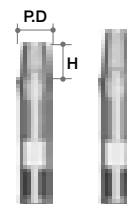

➔ Components for Solid Abutment

Comfort Cap

- Protects a Solid Abutment and minimizes irritation to tongue and oral mucosa.
- Easily make a temporary crown by resin build up.
- Color coded according to post heights.
[Yellow : PH 4.0mm, White : PH 5.5mm, Pink : PH 7.0mm]

Profile Diameter	Post Height(mm)	Ref.C
Ø4.0	4.0	CC4040
	5.5	CC4055
	7.0	CC4070
Ø4.5	4.0	CC4540
	5.5	CC4555
	7.0	CC4570
Ø5.5	4.0	CC5540
	5.5	CC5555
	7.0	CC5570
Ø6.5	4.0	CC6540
	5.5	CC6555
	7.0	CC6570

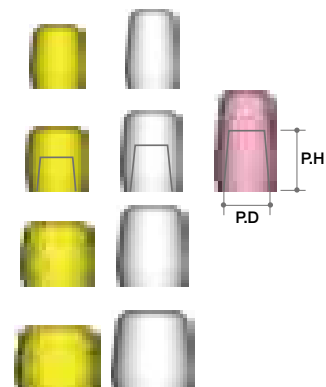

Snap Impression Coping

- Used for precise Impression Coping on Solid Abutment.
- Color coded for 3 different post heights.
[Yellow : PH 4.0mm, White : PH 5.5mm, Pink : PH 7.0mm]
- Do not use if Solid Abutment has been modified.

Profile Diameter	Post Height(mm)	Ref.C
Ø4.0	4.0	SIC4040
	5.5	SIC4055
	7.0	SIC4070
Ø4.5	4.0	SIC4540
	5.5	SIC4555
	7.0	SIC4570
Ø5.5	4.0	SIC5540
	5.5	SIC5555
	7.0	SIC5570
Ø6.5	4.0	SIC6540
	5.5	SIC6555
	7.0	SIC6570

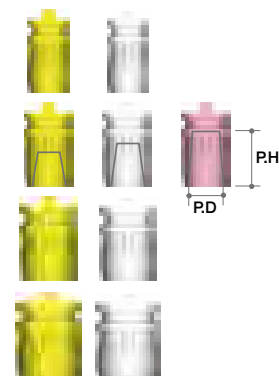

Burn-out Cylinder

- Precise fit with post of Solid Abutment, EZ Post Abutment, Lab Analog.
- Easy to wax up, provides accurate margins and clean burnout.
- Available both hex (red) and non-hex (white).

Profile Diameter	Type	Ref.C
Ø4.0	Single	BC4070S
Ø4.5		BC4570S
Ø5.5		BC5570S
Ø6.5		BC6570S
Ø4.0	Bridge	BC4070B
Ø4.5		BC4570B
Ø5.5		BC5570B
Ø6.5		BC6570B

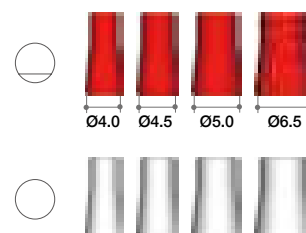

II. Abutment Level Prosthesis

2. Octa Abutment & Components

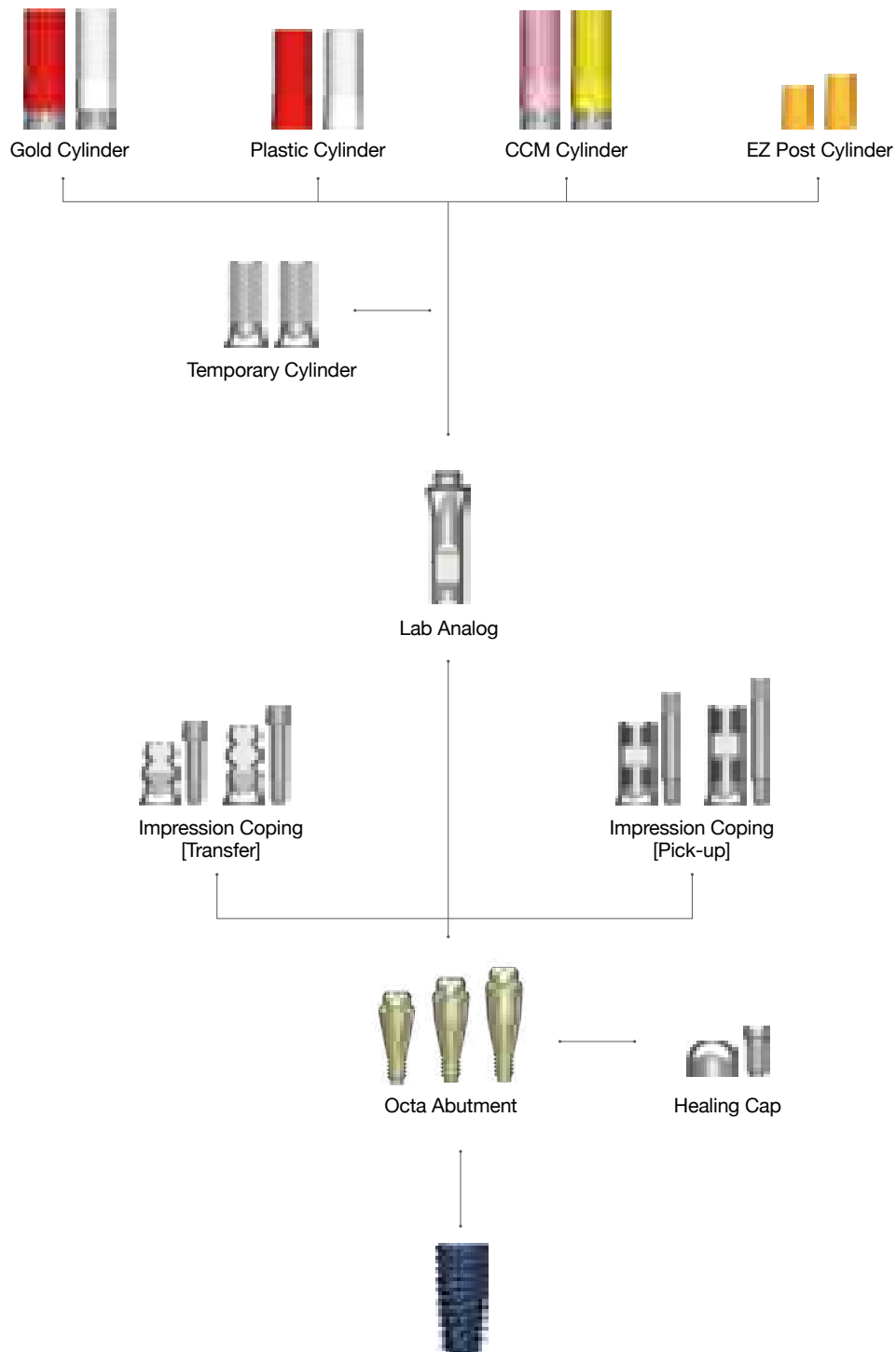

➔ Components for Octa Abutment (Continued)

Octa Abutment

- Used to make multiple screw-retained prosthetics.
- Recommend torque : 35Ncm
- Maximum path Angle : 70°

Profile Diameter	Cuff Height(mm)	Ref.C
Ø3.8	1.0	OA4010
	1.5	OA4015
	2.5	OA4025
	3.5	OA4035
	4.5	OA4045
Ø4.8	1.0	OA5010
	1.5	OA5015
	2.5	OA5025
	3.5	OA5035
	4.5	OA5045
Ø5.8	1.0	OA6010
	1.5	OA6015
	2.5	OA6025
	3.5	OA6035
	4.5	OA6045
	5.5	OA6055

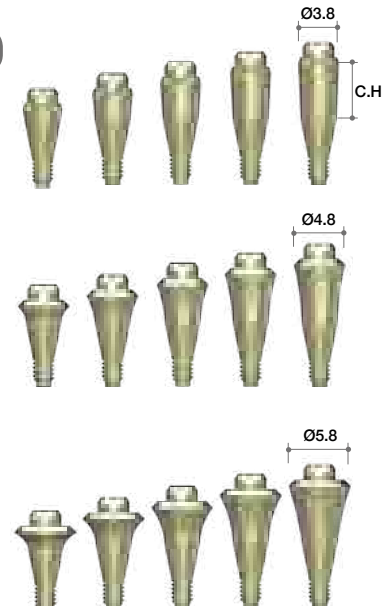

Healing Cap

- Cylinder Screw (IRCS200) included
- Protects Octa Abutment and minimizes irritation to tongue and oral mucosa.

Profile Diameter	Ref.C
Ø4.0	AANOHC4000T
Ø5.0	IHC400T
Ø6.0	AANOHC6000T



Impression Coping (Transfer)

- Guide Pin(AAOTGP10 / AAOTGP12) included
- Should be tightened with Impression Driver (Page.352)
- Special impression coping screw which can be used with a 1.2mm hex driver is available on request.

Profile Diameter	Height (mm)	Type	Ref.C
Ø4.0	7.5	Octa	AAOITO4010T
		Non-octa	AAOITN4010T
	9.5	Octa	AAOITO4012T
		Non-octa	AAOITN4012T
Ø5.0	7.5	Octa	AAOITO5010T
		Non-octa	AAOITN5010T
	9.5	Octa	AAOITO5012T
		Non-octa	AAOITN5012T
Ø6.0	7.5	Octa	AAOITO6010T
		Non-octa	AAOITN6010T
	9.5	Octa	AAOITO6012T
		Non-octa	AAOITN6012T

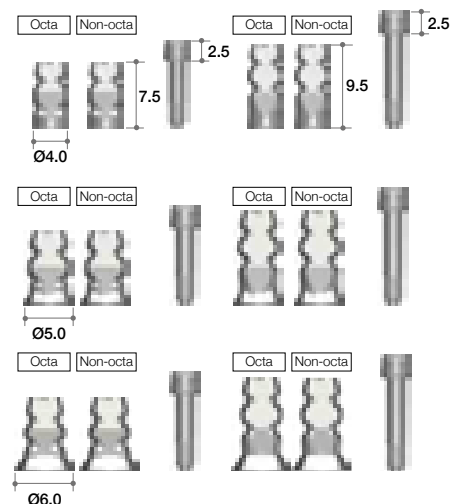

Impression Coping (Pick-up)

- Guide Pin included

Profile Diameter	Height (mm)	Type	Ref.C
Ø4.0	10.0	Octa	AAOIPO4010T
		Non-octa	AAOIPN4010T
	12.0	Octa	AAOIPO4012T
		Non-octa	AAOIPN4012T
Ø5.0	10.0	Octa	AAOIPO5010T
		Non-octa	AAOIPN5010T
	12.0	Octa	AAOIPO5012T
		Non-octa	AAOIPN5012T
Ø6.0	10.0	Octa	AAOIPO6010T
		Non-octa	AAOIPN6010T
	12.0	Octa	AAOIPO6012T
		Non-octa	AAOIPN6012T

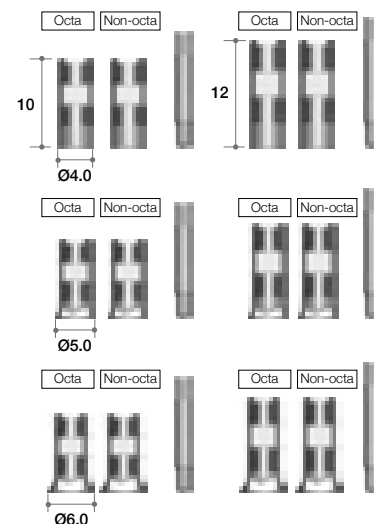

Lab Analog

Profile Diameter	Ref.C
Ø3.8	AANOLA4000
Ø4.8	IOA300
Ø5.8	AANOLA6000

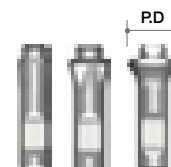

Temporary Cylinder

- Cylinder Screw (IRCS200) included

• Recommend torque : 25Ncm

Profile Diameter	Type	Ref.C
Ø4.0	Octa	AANOTCO4010T
	Non-octa	AANOTCN4010T
Ø5.0	Octa	AANOTCO5010T
	Non-octa	AANOTCN5010T
Ø6.0	Octa	AANOTCO6010T
	Non-octa	AANOTCN6010T

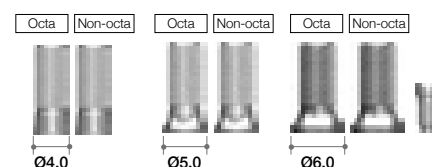

EZ Post Cylinder

- Cylinder Screw (IRCS200) included

• Recommend torque : 35Ncm

Profile Diameter	Post Height(mm)	Type	Ref.C
Ø4.0	5.5	Octa	AAOECO4005T
	7.0		AAOECO4007T
	5.5	Non-octa	AAOECN4005T
	7.0		AAOECN4007T
Ø5.0	5.5	Octa	AAOECO5005T
	7.0		AAOECO5007T
	5.5	Non-octa	AAOECN5005T
	7.0		AAOECN5007T
Ø6.0	5.5	Octa	AAOECO6005T
	7.0		AAOECO6007T
	5.5	Non-octa	AAOECN6005T
	7.0		AAOECN6007T

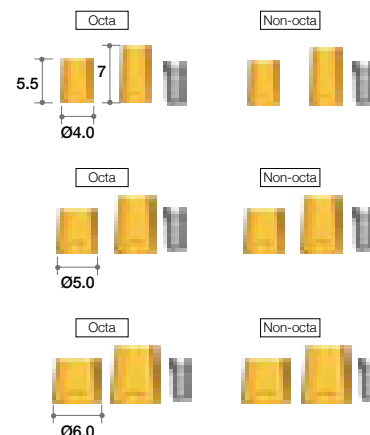

➔ Components for Octa Abutment

Gold Cylinder

- Cylinder Screw (IRCS200) included

- For customizing abutment for screw retained multi-unit restoration.
 - Available in both octa(red) and non-octa(white)
- Melting point of gold alloy : 1063°C
- Threaded sleeves allow for better retention of resin or wax.
- Available in three diameters (Ø4.0, Ø5.0 & Ø6.0).
- Recommend torque : 30Ncm

Profile Diameter	Type	Ref.C
Ø4.0	Octa	AANGCO4000T
	Non-octa	AANGCN4000T
Ø5.0	Octa	ILOGO100T
	Non-octa	IIGN100T
Ø6.0	Octa	AANGCO6000T
	Non-octa	AANGCN6000T

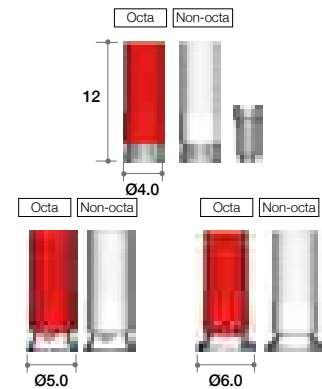

CCM Cylinder

- Cylinder Screw (IRCS200) included

- Useful to make a customized abutment in difficult situations.
- Can be casted with non-precious alloys (Ni-Cr, Cr-Co alloys).
- Non-precious melting temperature : Depend on Manufacturer.
- Threaded sleeves for convenient Resin / Wax-up.
- Melting temperature of CCM : 1300~1400°C
- Recommend torque : 35Ncm

Profile Diameter	Type	Ref.C
Ø4.0	Octa	AANCCO4000T
	Non-octa	AANCCN4000T
Ø5.0	Octa	AANCCO5000T
	Non-octa	AANCCN5000T
Ø6.0	Octa	AANCCO6000T
	Non-octa	AANCCN6000T

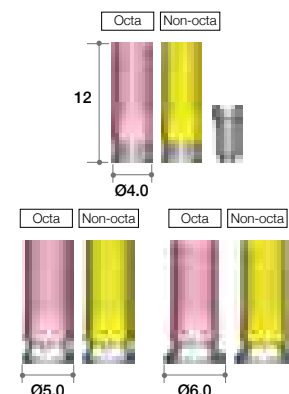

Plastic Cylinder

- Cylinder Screw (IRCS200) included

- Economical option
- Used for customizing abutment for screw retained multi-unit restorations.
 - Available in both octa(red) and non-octa(white)
- Threaded sleeves allow for better retention of resin or wax.
- Recommend torque : 25Ncm

Profile Diameter	Type	Ref.C
Ø4.0	Octa	AAOTCO4010T
	Non-octa	AAOTCN4010T
Ø5.0	Octa	IOPH100T
	Non-octa	IOPN100T
Ø6.0	Octa	AAOTCO6010T
	Non-octa	AAOTCN6010T

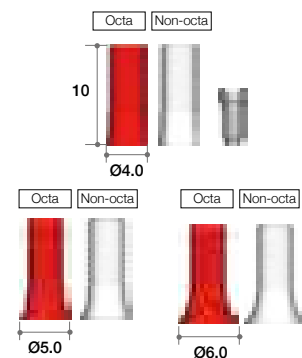

II. Abutment Level Prosthesis

3-1. Multi-unit Abutment & Components (All-on-4) (N-Type)

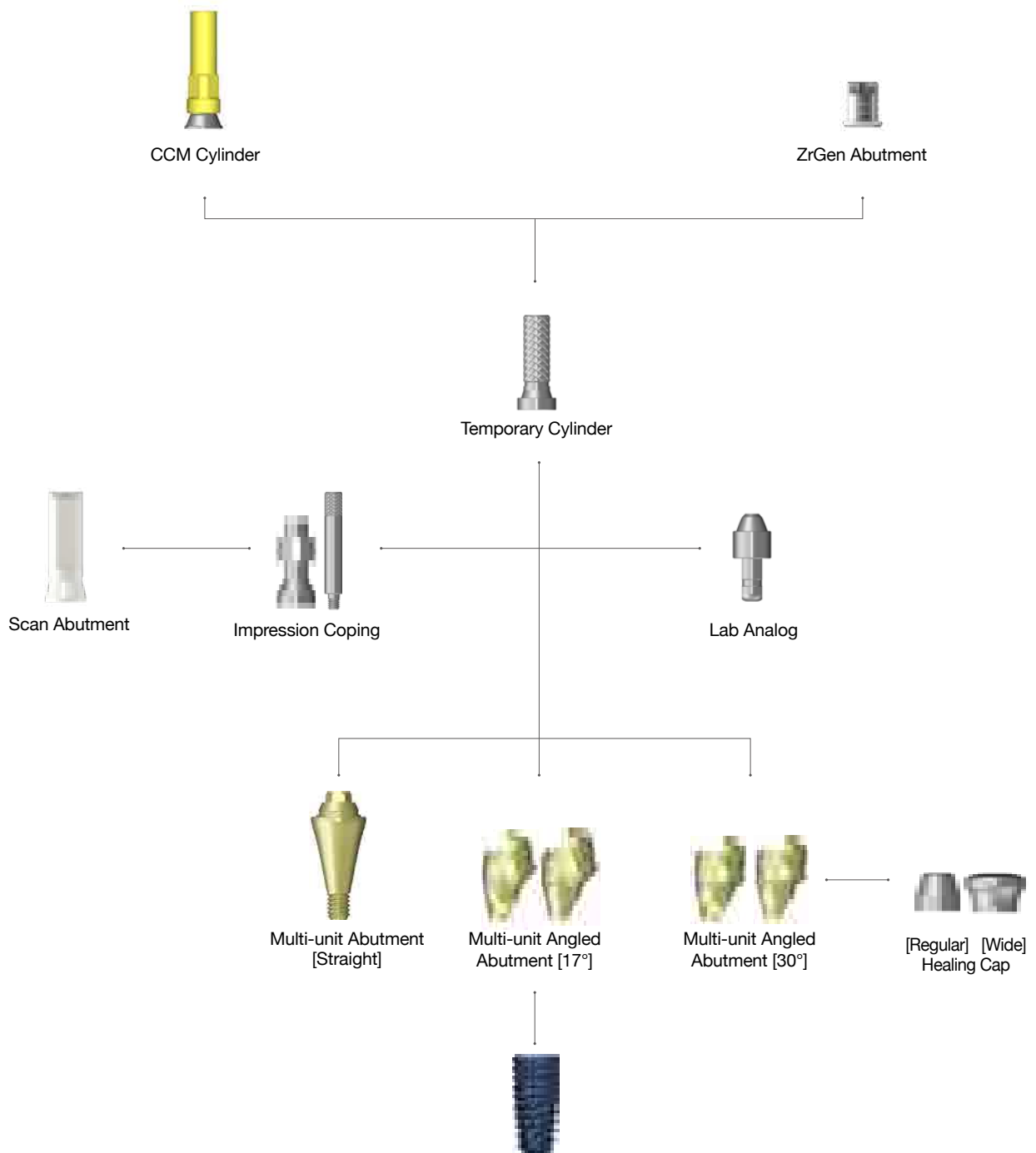

➔ Components for Multi-unit Abutment (Continued)

• For the design concept and rationale of the Multi-unit Abutment

Multi-unit Abutment [AO] - Straight

- MUA Straight Carrier (MUASC) included

• Recommend torque : 35Ncm

Cuff Height (mm)	Type	Ref.C
1.5	1-piece (M2)	MUAAON0015C
2.5		MUAAON0025C
3.5		MUAAON0035C
4.5		MUAAON0045C

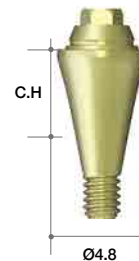

Multi-unit Angled Abutment [AO] - 17°

- MUA Screw (MUAOS) included

- MUA Angled Carrier (MUAAC) included

• Recommend torque : 25Ncm

Cuff Height (mm)	Type	Ref.C
2.5	Hex	MUAAOH1725TC
3.5		MUAAOH1735TC
4.5		MUAAOH1745TC
2.5	Non-Hex	MUAAON1725TC
3.5		MUAAON1735TC
4.5		MUAAON1745TC

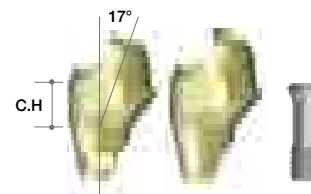

Multi-unit Angled Abutment [AO] - 30°

- MUA Screw (MUAOS) included

- MUA Angled Carrier (MUAAC) included

• Recommend torque : 25Ncm

Cuff Height (mm)	Type	Ref.C
3.5	Hex	MUAAOH3035TC
4.5		MUAAOH3045TC
3.5	Non-Hex	MUAAON3035TC
4.5		MUAAON3045TC

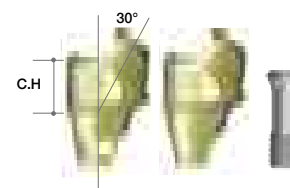

Impression coping (Pick-up)

- Guide pin (MUAGP) included

- Use to take an impression at the abutment level.
- Open tray method.

Connection	Ref.C
Non-Hex	MUAICT

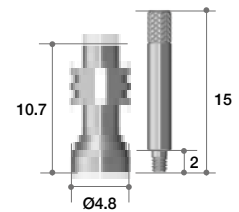

Lab Analog

- Use to duplicate the Multi-unit abutment in the working model.
- Available to use as a RP Analog for 3D printed working model.

Head form	Ref.C
Multi-unit Abutment(Nobel)	MUALA

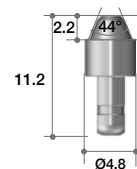

Temporary Cylinder

- Cylinder Screw (MUAS) 2EA included

- Use for fabricating acrylic provisional restoration.
- Grooves on the post cylinder allow storing resin adhesion.
- Back-up screw is included.
- Recommend torque : 15Ncm

Connection	Ref.C
Non-Hex	MUATCL

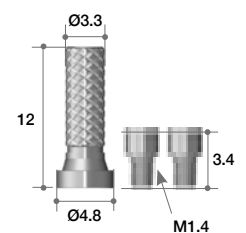

CCM Cylinder

- Cylinder Screw (MUAS) 2EA included

- Use for fabricating screw retained prostheses with metal reinforced or bar structured overdentures.
- Available to cast with non-precious dental alloys (Ni-Cr, Cr-Co alloys)
- Melting temperature of CCM base: 1300~1400°C
- Back-up screw is included.
- Recommend torque : 15Ncm

Connection	Ref.C
Non-Hex	MUACCML

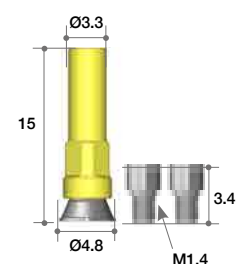

➡ Components for Multi-unit Abutment (Continued)

Healing Cap

- Cylinder Screw (MUAS) 2ea included
- The size of healing cap can be selected depending on soft tissue volume or type of restorations.

Type	Ref.C
Regular	MUAHCL
Wide	MUAHCWL

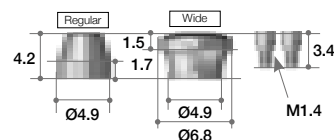

Healing Cap Set reference code

Order code : Add "P" after the existing reference code

Ex) MUAHCL → MUAHCP

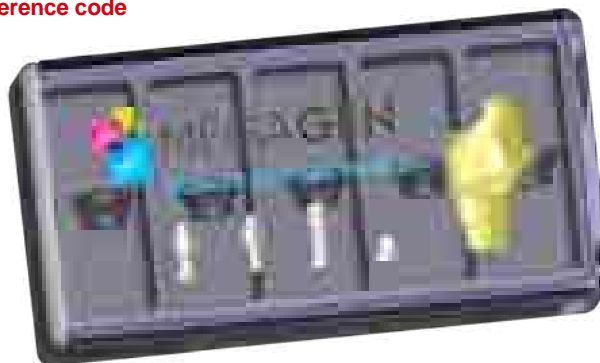

Try-in Abutment

- Cuff height is indicated with laser markings
- Straight, 17°, 30°
- Non-hex type

Angle	Cuff Marking	Ref.C
Straight	1.5 / 2.5 / 3.5 / 4.5	MUTIAAO00C
17°	2.5 / 3.5 / 4.5	MUTIAAO17C
30°	3.5 / 4.5	MUTIAAO30C

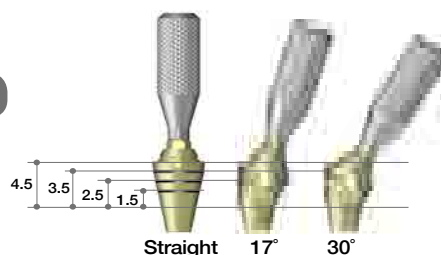

Try-in Abutment Set reference code

Order code : MUTIAAO00C P



- * Available Systems : AnyRidge, AnyOne Internal, AnyOne External
- * Kit contains Straight, 17° and 30° type of Try-in Abutments (1 each)



Multi-unit Driver

- Use to torque straight type Multi-unit Abutments.
- Use with a torque wrench (ref code: **MTW300A**)

Hex	Length	Ref.C
2.0	10	MUD10

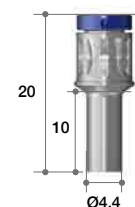

Right Angle Driver

- Use to torque straight type Multi-unit Abutments.
- Use with latch-type handpiece.
- Use with Meg-TORQ (ref code: **MEG_TORQ**)

Hex	Length	Ref.C
2.0	10	MURAD10

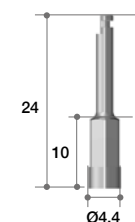

Hand Driver

- Use for abutment screw with 1.2 hex hole.
- Use up to 15° divergent.
- It should use under 30Ncm torque.

Hex	Length	Ref.C
1.2	20	MUHD1220

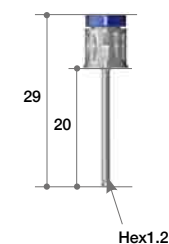

Removal Driver

- Use for abutment screw with 1.2 hex hole.
- Use up to 15° divergent.
- Exclusively for AnyRidge system.
- It should use under 30Ncm torque.

Hex	Length	Ref.C
1.2	20	MJARD20

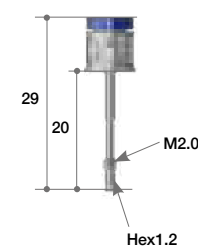

►► Multi-unit Abutment Set Contents

Multi-unit Abutment Healing cap type Set reference code

Order code : Add "HP" after the existing reference code

Ex) MUAAOH1725TC → MUAAOH1725 HP

Multi-unit Abutment CCM type Set reference code

Order code : Add "P" after the existing reference code

Ex) MUAAOH1725TC → MUAAOH1725 P

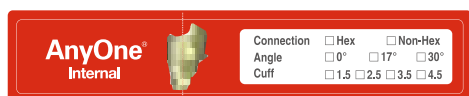

AnyOne
Internal

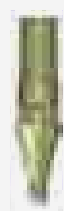

Cuff
1.5mm
2.5mm
3.5mm
4.5mm



Cuff
2.5mm
3.5mm
4.5mm



Cuff
3.5mm
4.5mm

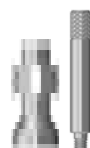

Impression
Coping



Lab Analog



Temporary
Cylinder

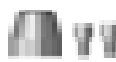

Healing
Cap
(Regular)

OR



CCM
Cylinder

▶▶ Starting Package Contents



	Type	Ref.C
Healing Cap	Hex	SKAOHN3000H
	Non Hex	SKAONN3000H
CCM Abutment	Hex	SKAOHN3000
	Non Hex	SKAONN3000

Straight 8set (2set x 4kind of cuff)	Angle 17° 6set (2set x 3kind of cuff)	Angle 30° 4set (2set x 2kind of cuff)
<p>Multi-unit Abutment with *carrier</p> <p>* MUA carrier is used to pick-up an abutment to the patient's mouth, and check its insertion angle.</p> <p>Healing Cap (Regular) or CCM Cylinder Temporary Cylinder Lap Analog Impression Coping</p>		

Surgical Instrument

Multi-unit Driver Right Angle Driver Hand Driver Removed Driver

Healing Cap 2set

Regular
Wide

Try-in Abutment 1set
(Straight, 17°, 30° each 1ea)

Surgical Guide 2ea

➔ Components for Multi-unit Abutment

Surgical Guide

- The distance between the lines is 7mm
- Put center pin after initial drilling at the centric of arch.

Angle	Marking Length	Ref.C
30	7	MUSG70

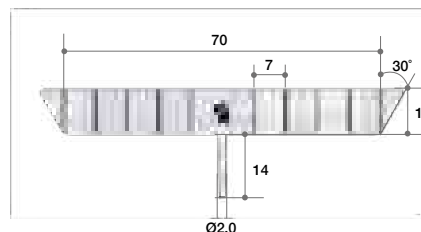

▶▶ How to use Surgical Guide

- ※ As Canine and 2nd premolar are most commonly used, the surgical guide has thicker lines for easier identification.
- ※ The surgical guide is able to use for 1st molar depending on surgical plan.

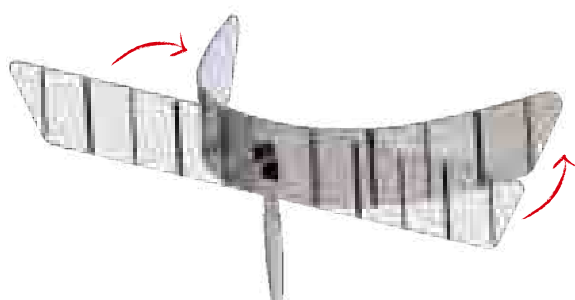

Bend to use

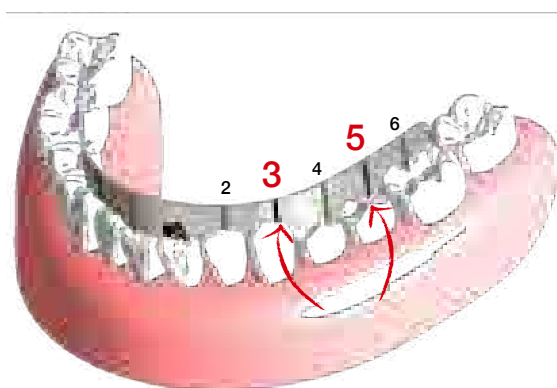

[Packing]

II. Abutment Level Prosthesis

3-2. Multi-unit Abutment & Components (All-on-4) (S-Type)

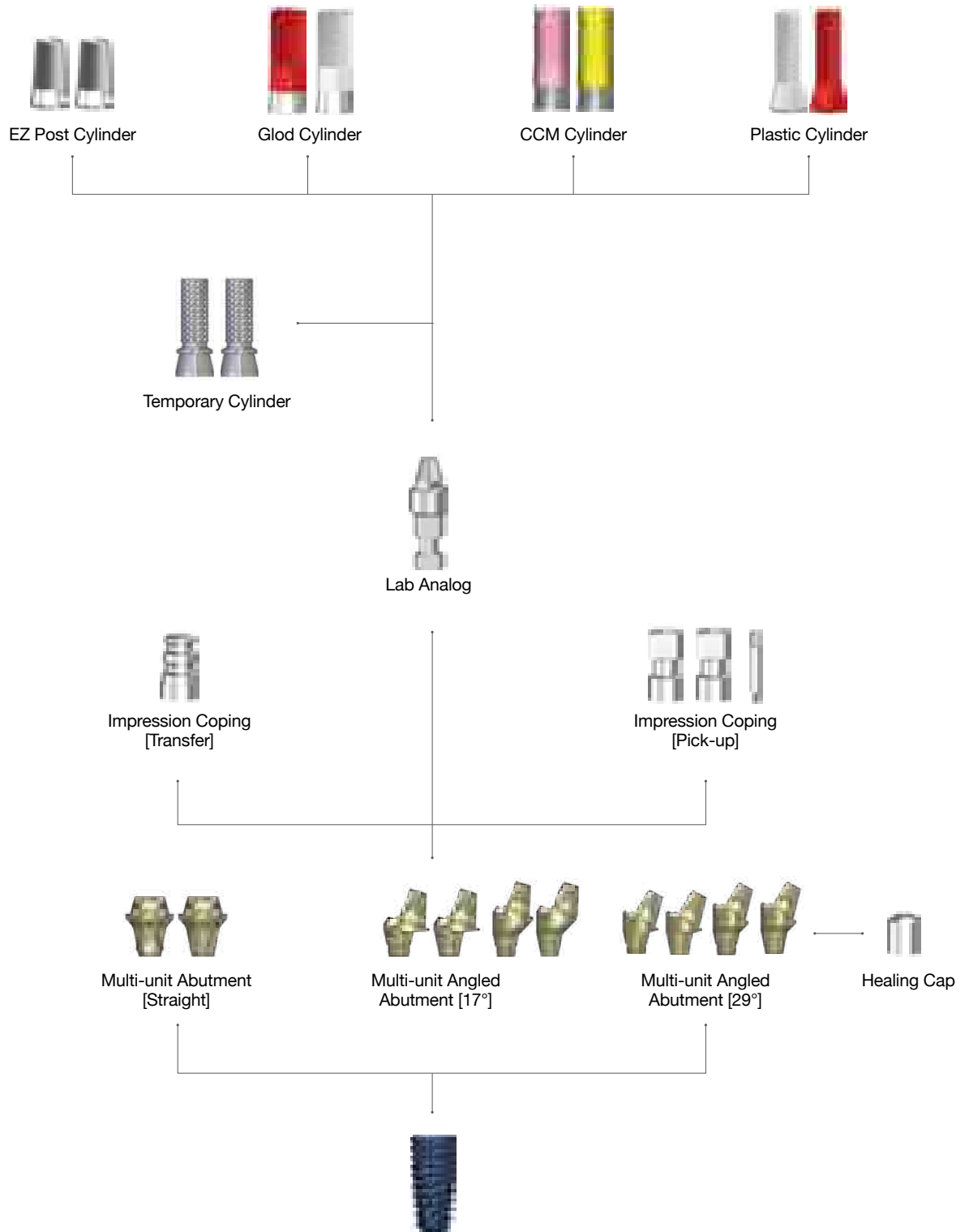

➔ Components for Multi-unit Abutment (Continued)

Multi-unit Abutment (Straight)

- Multi-unit Abutment Screw (MUS15 / MUS25 / MUS35 / MUS45 / MUS55) included.

• Recommend torque : 35Ncm

Cuff Height (mm)	Type	Ref.C
1.5	Hex	MU5015HT
2.5		MU5025HT
3.5		MU5035HT
4.5		MU5045HT
5.5		MU5055HT
1.5	Non-Hex	MU5015NT
2.5		MU5025NT
3.5		MU5035NT
4.5		MU5045NT
5.5		MU5055NT

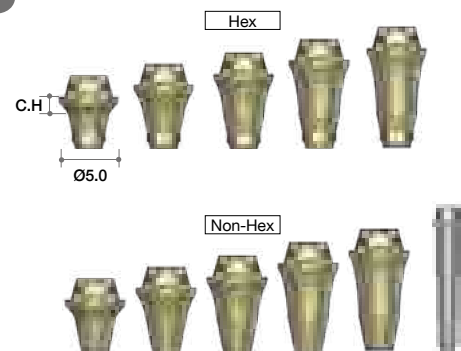

Multi-unit Angled Abutment (17°)

- Abutment Screw (MUAS20) included

• Recommend torque : 35Ncm

Cuff Height (mm)	Type	Ref.C
1.0	Hex	MU50117HT
2.0		MU50217HT
3.0		MU50317HT
4.0		MU50417HT
1.0	Non-Hex	MU50117NT
2.0		MU50217NT
3.0		MU50317NT
4.0		MU50417NT

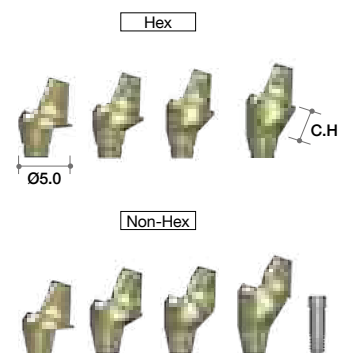

Multi-unit Angled Abutment (29°)

- Abutment Screw (MUAS20) included

• Recommend torque : 35Ncm

Cuff Height (mm)	Type	Ref.C
1.0	Hex	MU50129HT
2.0		MU50229HT
3.0		MU50329HT
4.0		MU50429HT
1.0	Non-Hex	MU50129NT
2.0		MU50229NT
3.0		MU50329NT
4.0		MU50429NT

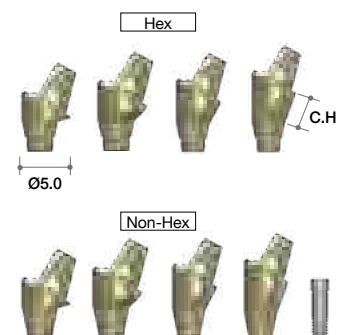

Healing Cap

Profile Diameter	Ref.C
Ø5.0	REC600



Impression Coping (Transfer)

Profile Diameter	Ref.C
Ø4.8	RITE480



Impression Coping (Pick-up)

- Guide Pin (RICG150) included

Height (mm)	Ref.C
9.4	RIEH480T
	RIEN480T



Lab Analog

Profile Diameter	Ref.C
Ø4.8	RELA300



Temporary Cylinder

- Cylinder Screw (TASH140) included
 • Recommend torque : 15Ncm

Profile Diameter	Ref.C
Ø4.8	ETH100T
	ETN100T

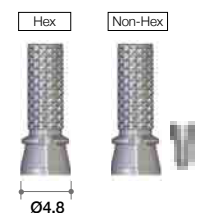

➔ Components for Multi-unit Abutment

EZ Post Cylinder

- Cylinder Screw (TASH140) included
- Recommend torque : 15Ncm

Profile Diameter	Type	Ref.C
Ø5.0	Hex	RCA900T
	Non-Hex	RCA800T

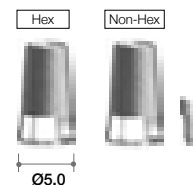

Gold Cylinder

- Cylinder Screw (TASH140) included
- For customizing abutment for screw retained multi-unit restoration.
 - Available in both octa(red) and non-octa(white)
- Melting point of gold alloy : 1063°C
- Threaded sleeves allow for better retention of resin or wax.
- Available in three diameters (Ø4.0, Ø5.0 & Ø6.0).
- Recommend torque : 15Ncm

Profile Diameter	Sleeve color	Ref.C
Ø4.8	Red	REGC200T
	White	REGC100T

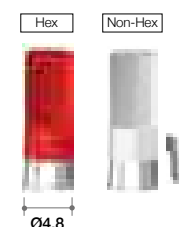

CCM Cylinder

- Cylinder Screw (TASH140) included
- Useful to make a customized abutment in difficult situations.
- Can be casted with non-precious alloys (Ni-Cr, Cr-Co alloys).
- Non-precious melting temperature : Depends on Manufacturer
- Threaded sleeves for convenient Resin/ Wax-up.
- Melting temperature of CCM : 1300~1400°C
- Recommend torque : 15Ncm

Profile Diameter	Sleeve color	Ref.C
Ø4.8	Pink	RCA5013HT
	Yellow	RCA5013NT

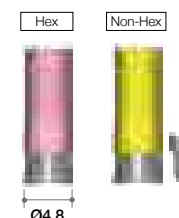

Plastic Cylinder

- Cylinder Screw (TASH140) included
- Economical option
- Used for customizing abutment for screw retained multi-unit restorations.
 - Available in both octa(red) and non-octa(white)
- Threaded sleeves allow for better retention of resin or wax.
- Recommend torque : 15Ncm

Profile Diameter	Sleeve color	Ref.C
Ø5.2	Red	RPEH100T
	White	RPEN100T

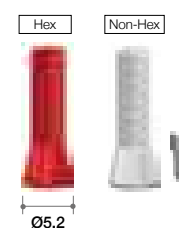

II. Abutment Level Prosthesis

4. Flat Abutment & Components

: The main advantage of this Flat Abutment is the freedom on angulation.

Flat Abutment can cover any angulation problems.

: Only for multiple (Cannot be used for single implant)

: Only with screw retained prosthetics.

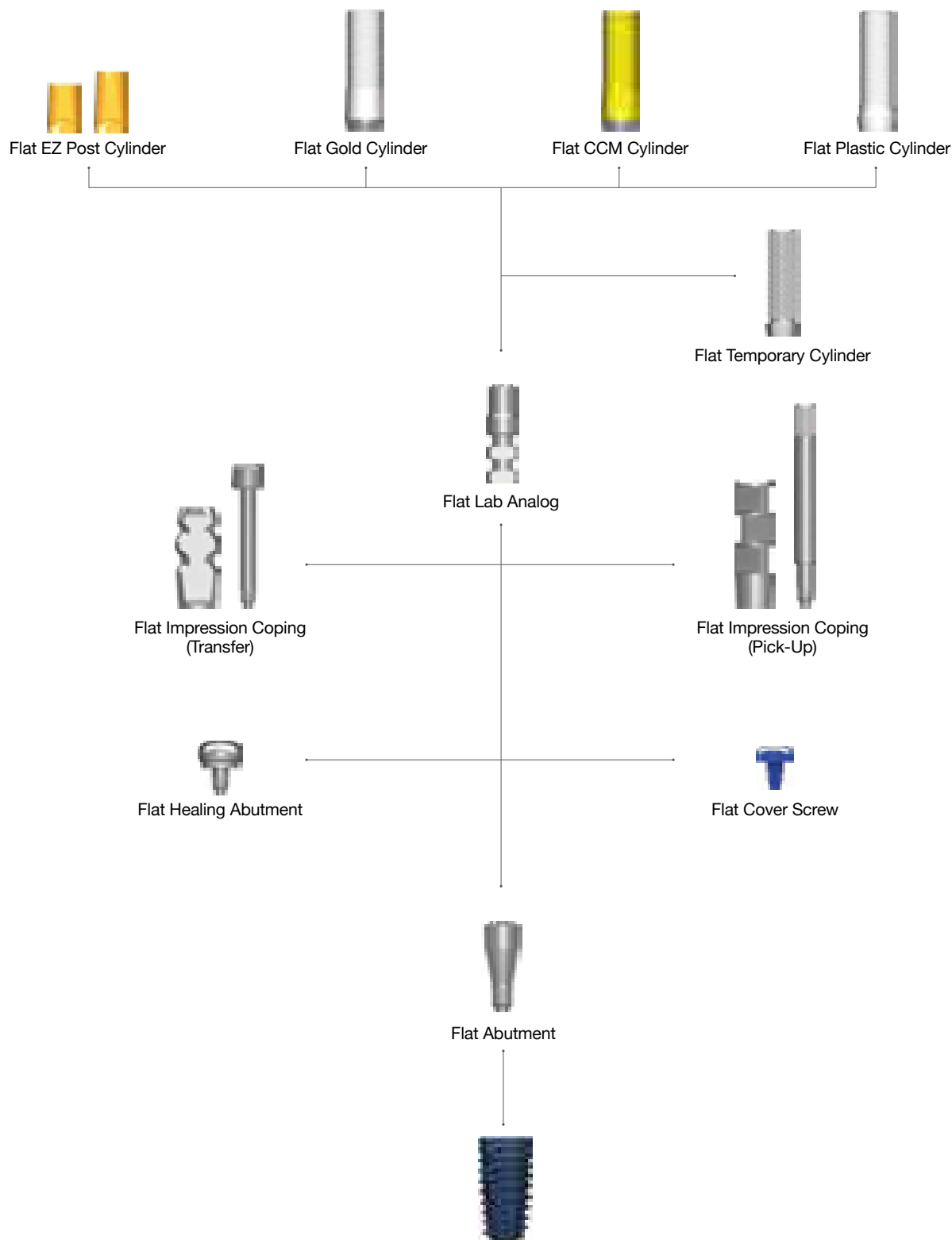

➔ Components for Flat Abutment

Flat Abutment

- Use Hand Driver (1.6 Hex)

• Recommend torque : 25Ncm

Profile Diameter	Cuff Height (mm)	Ref.C
Ø3.5	1.5	FA3515
	2.5	FA3525
	3.5	FA3535
	4.5	FA3545
	5.5	FA3555

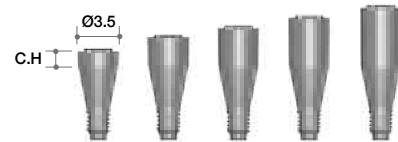

Flat Cover Screw

• Recommend torque : by hand (5 - 8Ncm)

Profile Diameter	Ref.C
Ø3.5	FCS3510



Flat Healing Abutment

• Recommend torque : by hand (5 - 8Ncm)

Height (mm)	Ref.C
2	FHA402
3	FHA403
4	FHA404



Flat Impression Coping (Transfer)

- Guide Pin (FGPT74) included.

• Should be tightened with Impression Driver (Page.271)

• Special impression coping screw which can be used with a 1.2mm hex driver is available on request.

Profile Diameter	Height (mm)	Ref.C
Ø4.0	9.5	FIT4012T

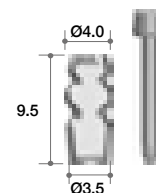

Flat Impression Coping (Pick-Up)

- Guide pin (FGPP15) included.

Profile Diameter	Height (mm)	Ref.C
Ø4.0	12	FIP4012T

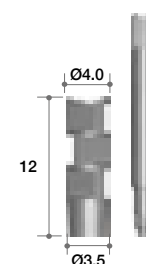

Flat Lab Analog

Profile Diameter	Height (mm)	Ref.C
Ø3.5	12	FLA3512

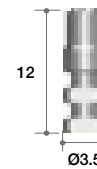

Flat Temporary Cylinder

- Flat Cylinder Screw (FAS) included.

• Recommend torque : 15Ncm

Profile Diameter	Ref.C
Ø4.0	FTC4012T

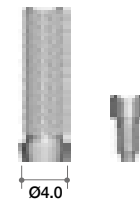

Flat EZ Post Cylinder

- Flat Cylinder Screw (FAS) included.

• Recommend torque : 25Ncm

Height (mm)	Ref.C
5.5	FEC4005T
7.0	FEC4007T



Flat Gold Cylinder

- Flat Cylinder Screw (FAS) included.

- Useful to make a customized abutment in difficult situations.
- Precious and non-precious alloys.
- Melting point of gold alloy : 1063°C
- Threaded sleeves for convenient Resin / Wax-up.
- Recommend torque : 25Ncm

Profile Diameter	Ref.C
Ø3.8	FGC4012T

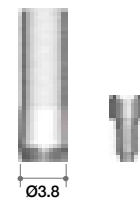

Flat CCM Cylinder

- Flat Cylinder Screw (FAS) included.

- Useful to make a customized abutment in difficult situations.
- Can be casted with non-precious alloys (Ni-Cr, Cr-Co alloys).
- Non-precious melting temperature : Depend on Manufacturer
- Threaded sleeves for convenient Resin / Wax-up.
- Melting temperature of CCM : 1300~1400°C
- Recommend torque : 25Ncm

Profile Diameter	Ref.C
Ø3.8	FCC4012T



Flat Plastic Cylinder

- Flat Cylinder Screw (FAS) included.

• Recommend torque : 25Ncm

Profile Diameter	Ref.C
Ø4.0	FPC4012T

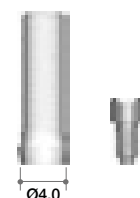

NEW PRODUCT

III. Overdenture Prosthesis

1. MegaGen Overdenture System

Meg-Loc

Compatible with products L and K, excellent functionality, & incomparable price!

Combination of Titanium housing and Pekkton (reinforced plastic) creates low water solubility and higher wear resistance and durability than other existing products.

Retention insert offers wide range of retention forces (600gf, 1200gf, 1800gf) to suit each patient, resulting in high level of satisfaction for both patient and dentist. Strong physical properties of Pekkton and insert gap increase elasticity, so that insert does not tear or break unlike conventional nylon products, thereby ensuring strong retention and longer life.

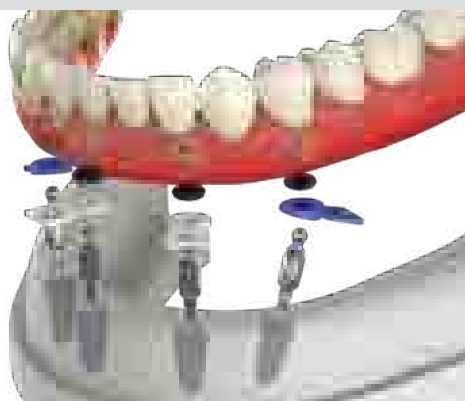

Meg-Ball

Smallest housing, retentive ring with longer life!

Even when the implant angle is not parallel, a stable denture can still be produced!

Compatible with other products with Ø2.25 head size, minimized patient inconvenience due to small-size housing, simpler to arrange artificial teeth as space occupied by denture is reduced, and easier to maintain than other systems.

Retentive ring has a high elasticity, abrasion resistance, and durability, thereby doubling the length of life when compared to a silicone O-ring and guaranteeing a longer life than NBR products.

Positioner (0/5/10/15 degrees) maintains parallel housing direction, even with distorted implant placement angle, ensuring denture stability.

Meg-Magnet

Designed to maintain stable and sufficient magnetic force!
Completely blocks bursts and corrosion resistant!

Structure is connected with abutment using magnetic force, which is feasible even with insufficient bone volume or poor bone quality

Easy to attach and detach, and minimal inflammation.

Magnet of Ø4.5 & Ø5.0 is compatible with other products, and laser marking on upper part makes it easy to distinguish between up and down.

Sufficient magnetic force (450gf, 650gf) ensures stable retention

Laser sealing blocks any bursting phenomenon.

TiN coating provides corrosion resistance.

Positioner (small & regular) prevents magnet from slipping in the mouth and stops any flow of impression materials under the abutment.

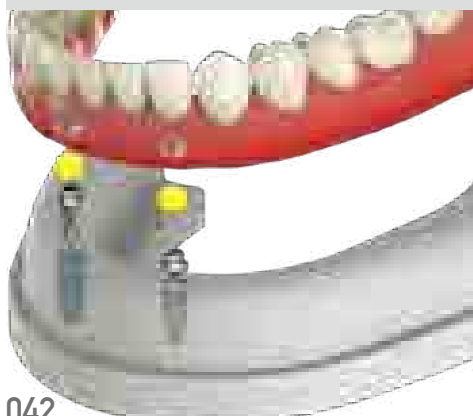
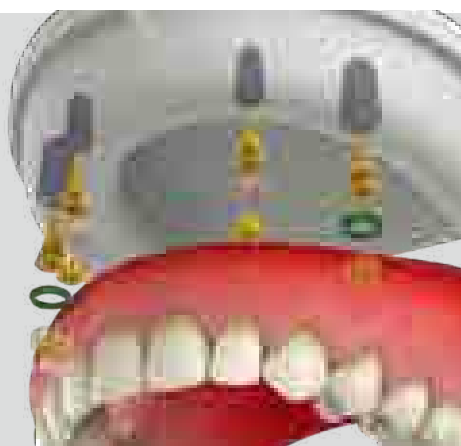

Meg-Rhein

Can compensate for tilted implant placement angle up to 50 °.

Combined head and housing structure is smallest on the market.

Retentive cap is based on Italian technology and has uniform physical properties. Various retention forces (600gf, 1200gf, 1800gf, 2700gf) classified by color can be selected according to each patient.

Dynamic housing with double structure enables tilting to 25 ° angle, allowing stable denture even when with distorted implant placement angle.

III. Overdenture Prosthesis

2. Meg-Loc Abutment & Component



Meg-Loc Metal Housing set



Block-out Spacer



Meg-Loc Abutment



►► Meg-Loc Overdenture System

Advantages

Easy compatibility

Compatible with Product L and Product K (same specifications)

Better abrasion resistance and durability

Combination of Titanium housing and reinforced plastic (Pekkton) provides low water solubility and high resistance, making it superior in abrasion resistance and durability compared to existing products.

Water Sorption Test

Property	Meg-Loc (Pekkton)	Product L	Unit
Water Sorption	8.7	93.5	µg/mm ³

Stronger retention and longer life

Strong physical properties of Pekkton and gap in insert increase the elasticity, preventing the insert from being torn or broken unlike existing nylon products, even when angle does not match when attaching & removing denture.

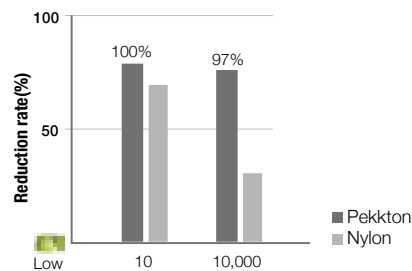

Easy to use

High resistance to plaque and easy cleaning
Easy replacement of retention insert

Tilting Angle



Various Retentive Caps of the Meg-Loc

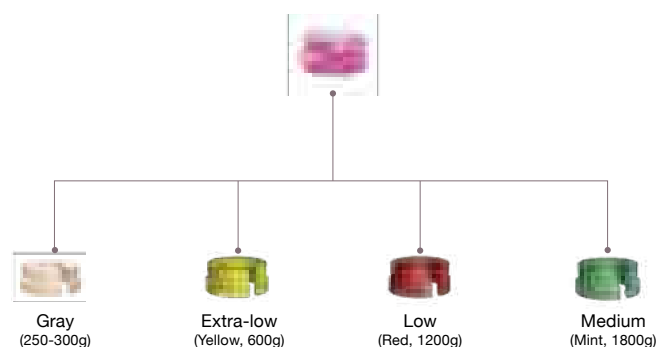

➔ Meg-Loc Overdenture System

Meg-Loc Abutment

- Angle compensation to one side 20 ° (both sides 40 °)
- Gently rounded shape
- Compatible with 1.2 Hex Driver
- Recommend torque : 35Ncm

Cuff Height (mm)	Ref.C
0	MLAO00
1.0	MLAO01
2.0	MLAO02
3.0	MLAO03
4.0	MLAO04
5.0	MLAO05
6.0	MLAO06

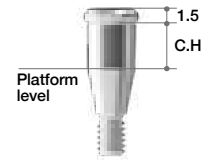

Meg-Loc Package

- 1 Meg-Loc Abutment

* Following package items are delivered with San DreMetto Korea packaging.

- 1 Titanium Housing
- 1 Block Out Spacer
- 4 Pekkton Retention Inserts (Gray-250~300gf(for lab), Yellow-600gf, Red-1200gf, Mint-1800gf)

Cuff Height (mm)	Ref.C
0	MLAO00P
1.0	MLAO01P
2.0	MLAO02P
3.0	MLAO03P
4.0	MLAO04P
5.0	MLAO05P
6.0	MLAO06P



Meg-Loc Attachment

Description	QTY	Ref.C
CM-LOC Attachment	SET	CM-LOC
Housing Titanium® for Pekkton® Inserts	4EA	CM-LOC-TP
Processing Insert (extra-low)	4EA	CM-LOC-PI
Insert (extra-low)	4EA	CM-LOC-EL
Insert (low)	4EA	CM-LOC-L
Insert (medium)	4EA	CM-LOC-M
Block-out Spacer	4EA	CM-LOC-BS

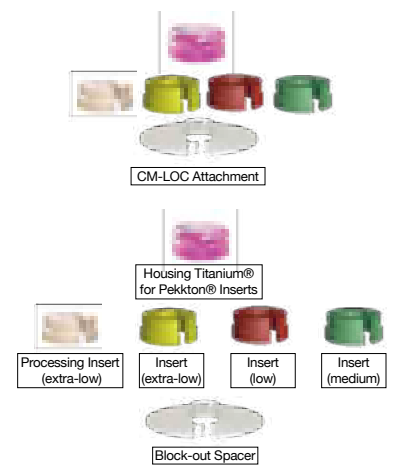

Multi Tool

- Retention insert Insert & Remove Tool

Ref.C
MLMT



III. Overdenture Prosthesis

3. Meg-Ball Abutment & Component



►► Meg-Ball Overdenture System

Advantages

Easy compatibility



Ø2.25 head size for easy compatibility with other products

Smallest Housing



Metal Housing

Small housing minimizes patient inconvenience, facilitates arrangement of artificial teeth by reducing space occupied by denture, and is easier to maintain than other systems.

Double length of life



Retentive Ring

High elasticity, abrasion resistance, and durability doubles the length of life when compared with silicone O-ring and guarantees longer life than NBR products.

Stable denture even when implant placement angle is distorted

Positioner (0/5/10/15 degrees) maintains parallel housing direction even when angle of implant placement is distorted, ensuring denture stability



0°



5°



10°



15°

Tilting Angle



➔ Meg-Ball Overdenture System

Meg-Ball Abutment

- Angle compensation to one side 15 °
(both sides 30 °)
- Ø2.25 Ball shape
- Recommend torque : 35Ncm

Cuff Height (mm)	Ref.C
0	MBAO00
1.0	MBAO10
2.0	MBAO20
3.0	MBAO30
4.0	MBAO40
5.0	MBAO50
6.0	MBAO60

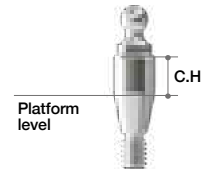

Meg-Ball Package

- Composed of Meg-Ball Abutment/
Metal Housing Set/
Housing Positioner (0°,5°,10°,15°)

Cuff Height (mm)	Ref.C
0	MBAO00P
1.0	MBAO10P
2.0	MBAO20P
3.0	MBAO30P
4.0	MBAO40P
5.0	MBAO50P
6.0	MBAO60P



Meg-Ball Metal Housing Set

- 1 Metal Housing
- 1 Retentive Ring

Ref.C
MBHR

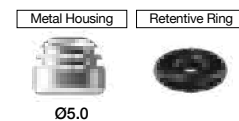

Retentive Ring Set

Quantity	Ref.C
5	MBR5
10	MBR10



III. Overdenture Prosthesis

4. Meg-Magnet Abutment & Component



►► Meg-Magnet Overdenture System

Advantages

Easy to apply for elderly patients or disabled patients

Designed for maximum magnetic efficiency and durability

Outstanding retention
 - Blocks bursting
 - Corrosion resistant
 - Abrasion resistant

Easy to distinguish between up and down via laser marking on upper section

No slippage of magnet

Component of the Meg-Magnet

Applicable with insufficient bone volume and poor bone quality
 Easy to attach and detach
 Unlikely to cause inflammation

Sufficient magnetic force (450gf, 650gf) to ensure stable retention
 Laser sealing blocks any bursting phenomenon

TiN coating provides corrosion resistance
 Over 0.1mm thickness at contact with attachment to ensure wear resistance



Magnet of Ø4.5 & Ø5.0 is compatible with other products
 Laser marking on upper part makes it easy to distinguish between up and down



Positioner (small & regular) prevents magnet from slipping in mouth and stops any flow of impression materials under the abutment

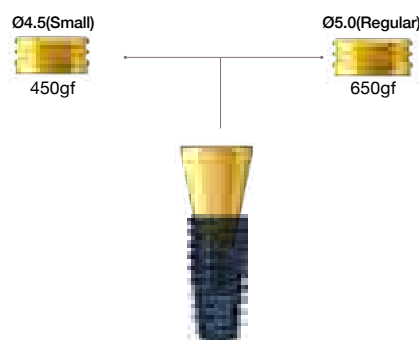

➔ Meg-Magnet Overdenture System

Meg-Magnet Abutment

- Use to 1.2 Hex Driver
- Recommend torque : 35Ncm

Profile Diameter	Cuff Height (mm)	Ref.C
Ø4.5	0	MMAO400
	1.0	MMAO410
	2.0	MMAO420
	3.0	MMAO430
	4.0	MMAO440
	5.0	MMAO450
Ø5.0	0	MMAO500
	1.0	MMAO510
	2.0	MMAO520
	3.0	MMAO530
	4.0	MMAO540
	5.0	MMAO550

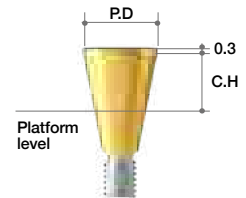

Meg-Magnet Package

- 1 Meg-Magnet Abutment
- 1 Magnet (Ø4.5-450gf, Ø5.0-650gf)
- 1 Magnetic Positioner

Profile Diameter	Cuff Height (mm)	Ref.C
Ø4.5	0	MMAO400P
	1.0	MMAO410P
	2.0	MMAO420P
	3.0	MMAO430P
	4.0	MMAO440P
	5.0	MMAO450P
Ø5.0	0	MMAO500P
	1.0	MMAO510P
	2.0	MMAO520P
	3.0	MMAO530P
	4.0	MMAO540P
	5.0	MMAO550P



Meg-Magnet Attachment Set

Size	Ref.C
Small	MA402
Regular	MA502

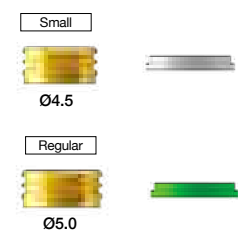

III. Overdenture Prosthesis

5. Meg-Rhein Abutment & Components

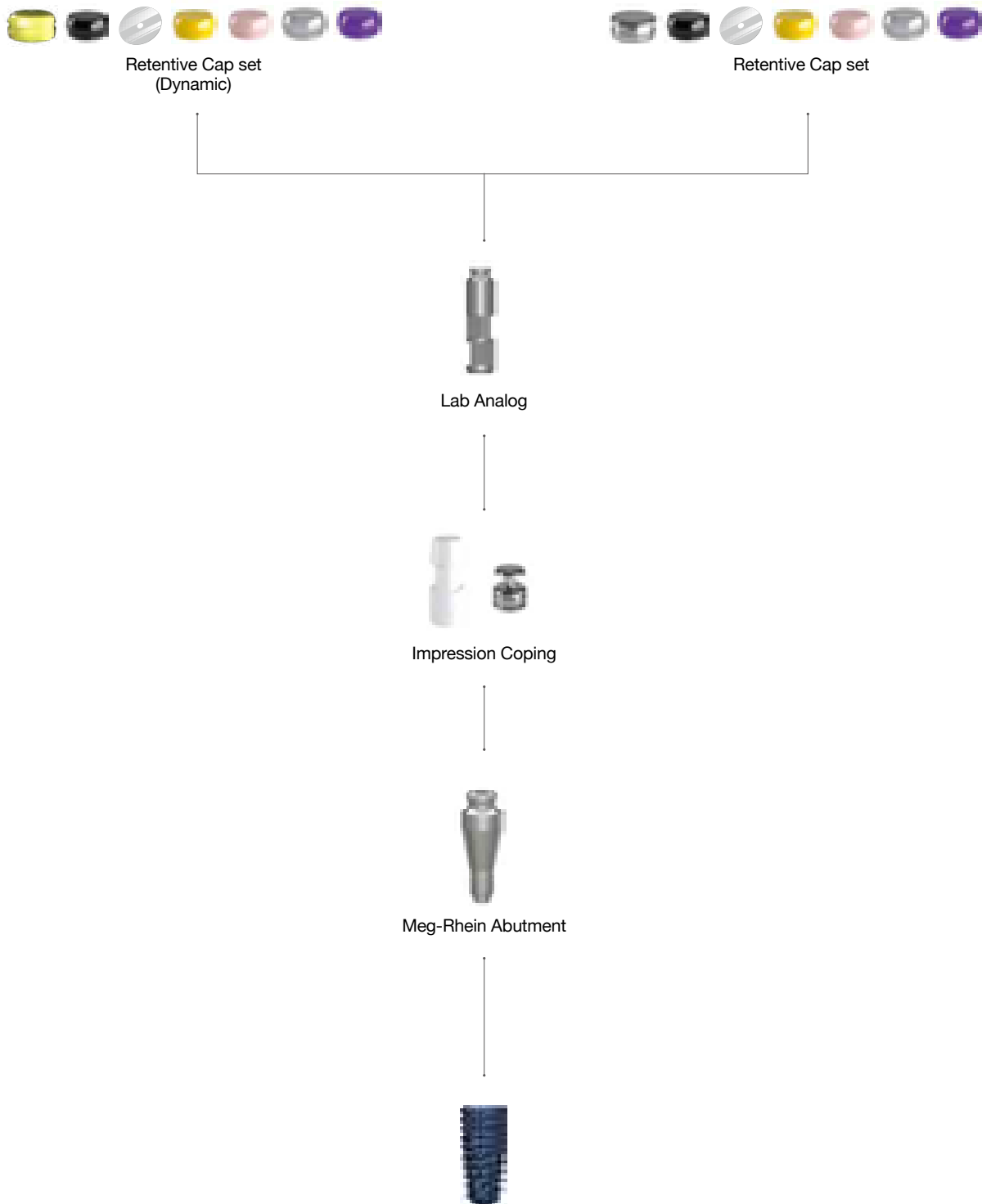

➔ Meg-Rhein Overdenture System

Meg-Rhein Overdenture System (Dynamic)

- 1 Meg-Rhein Abutment
- 1 Plastic Impression Coping
- 1 Stainless Steel Housing (Dynamic) & Black-Lab
- 1 Protective Disk
- 4 Retentive Caps
(Yellow-0.6kgf, Pink-1.2kgf, White-1.8kgf, Violet-2.7kgf)

- Perfect compatibility with the Rhein83 from Italy.
- Recommend torque : 15Ncm.

Cuff Height (mm)	Ref.C
0	DR00PA
1.0	DR01PA
2.0	DR02PA
3.0	DR03PA
4.0	DR04PA
5.0	DR05PA
6.0	DR06PA



Meg-Rhein Overdenture System

- 1 Meg-Rhein Abutment
- 1 Plastic Impression Coping
- 1 Stainless Steel Housing
- 1 Protective Disk
- 5 Retentive Caps
(Black-Lab, Yellow-0.6kgf, Pink-1.2kgf, White-1.8kgf, Violet-2.7kgf)

- Perfect compatibility with the Rhein83 from Italy.
- Recommend torque : 15Ncm.

Cuff Height (mm)	Ref.C
0	DR00P
1.0	DR01P
2.0	DR02P
3.0	DR03P
4.0	DR04P
5.0	DR05P
6.0	DR06P



►► Overdenture System

Advantages

Small & Easy-to-Use Housing System 

Tilting Angle

Various Retentive Caps of the Meg-Rhein

Low Reduction Rate & Uniform Variance of Retentive Force

Normal

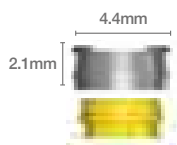

Dynamic

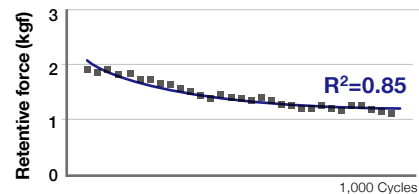
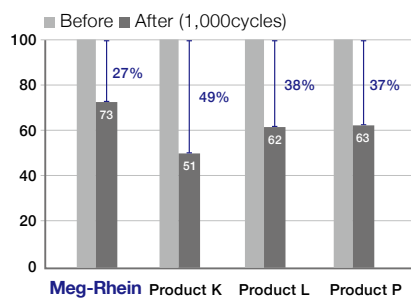
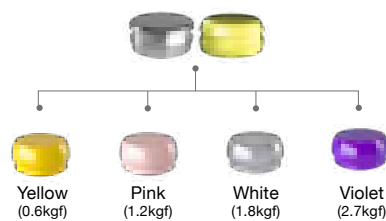
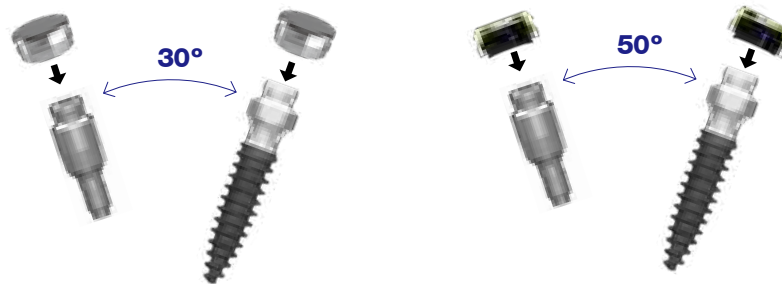
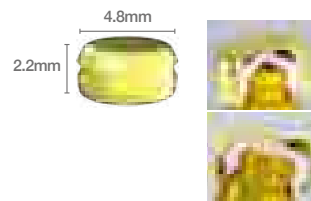

R^2 (Coefficient of determination) becomes more reliable when it is close to "1".

➔ Components for Meg-Rhein Abutment (Continued)

Stainless Steel Housing

- 5ea/pack

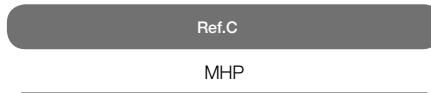

Stainless Steel Housing (Dynamic)

- 5ea/pack

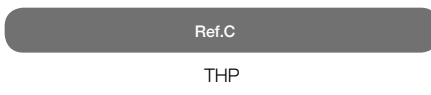

Retentive Caps (White)

- White cap(1.8kg) - For refill (5ea/pack).
- Can be used for more retentive force following pink cap(1.2kgf).

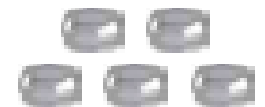
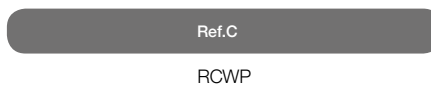

Retentive Caps (Violet)

- Violet cap(2.7kg) - For refill (5ea/pack).
- Can be used for more retentive force following white cap(1.8kgf).

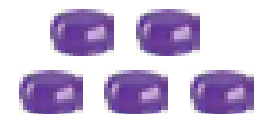
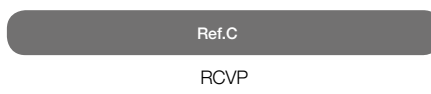

Retentive Caps (Pink)

- Pink cap(1.2kgf) - For refill (5ea/pack).

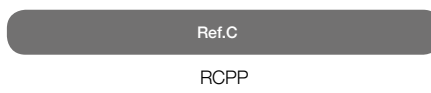

➔ Components for Meg-Rhein Abutment

Retentive Caps (Yellow)

- Yellow cap(0.6kgf) - For refill (5ea/pack).

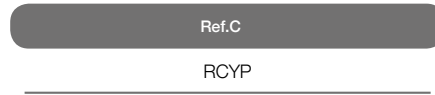

Retentive Caps (Black)

- For laboratory

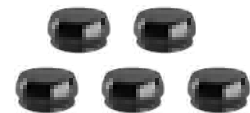
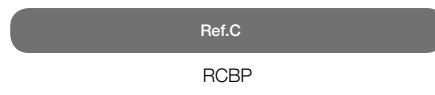

Stainless Impression Coping (Pick-Up)

- 2ea/pack.
- Italy - Rhein 83 products.
- For accurate (pick-up type) impression.
- Metal with groove design to prevent from swaying.

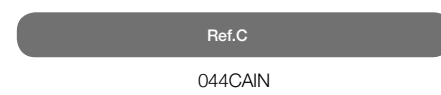

Lab Analog

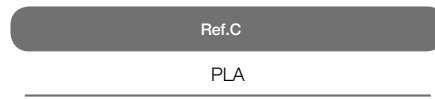

Retentive Cap Removal Tool

- Retentive Cap removal tool.

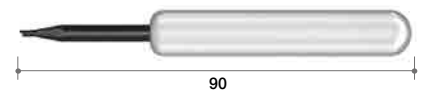
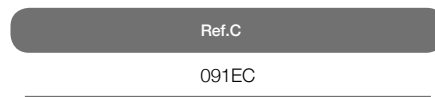

Retentive Cap Insertion Tool

- Retentive Cap insertion tool.

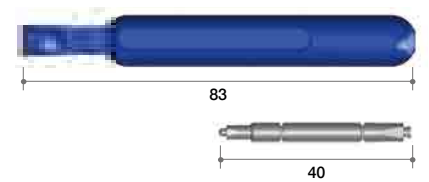
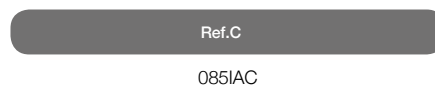

AnyOne Surgical Kit

I. AnyOne Internal Kit

Ref.C
KA0IN3003

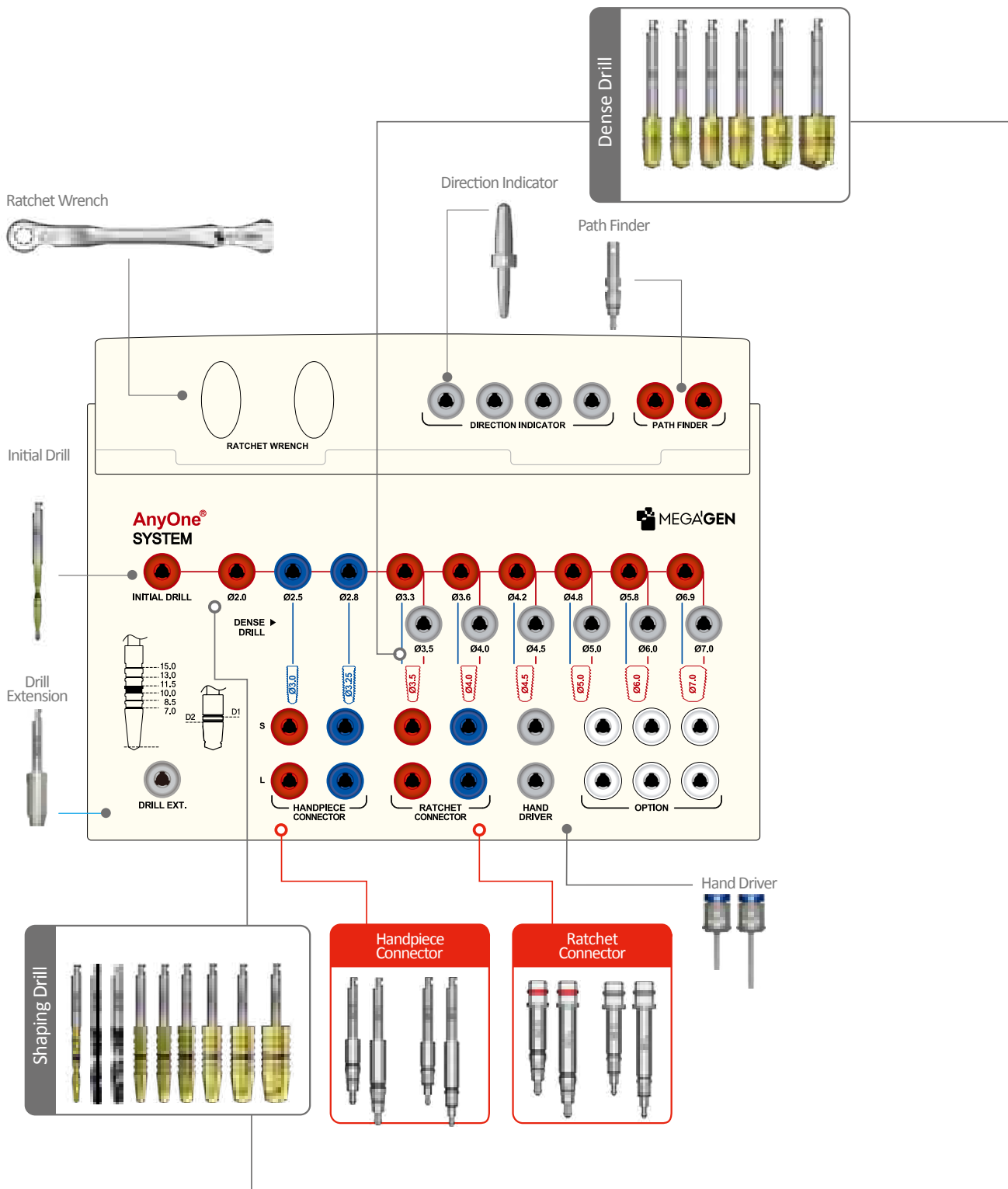

Shaping Drill

- Each drill has depth marking lines from 7.0mm to 15.0mm
- The dual marking system (grooves and laser markings) provides visual and radio graphic depth verification during surgery.

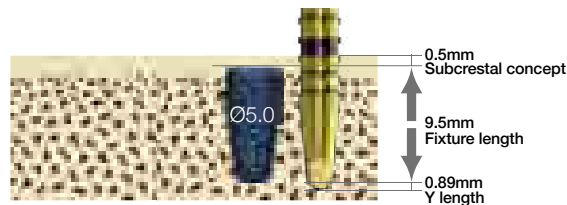

Drill Diameter	Ø2.8	Ø3.3	Ø3.6	Ø4.2	Ø4.8	Ø5.8	Ø6.9
Y length	0.58	0.59	0.68	0.85	0.89	0.94	0.94

※ Actual drill length : Drill length does not normally include the Y dimension of the drill.

※ Markings on the Shapping Drill are 0.5mm longer than the fixture so fixtures will automatically be placed 0.5mm subcrestally if the drilling protocol is followed.

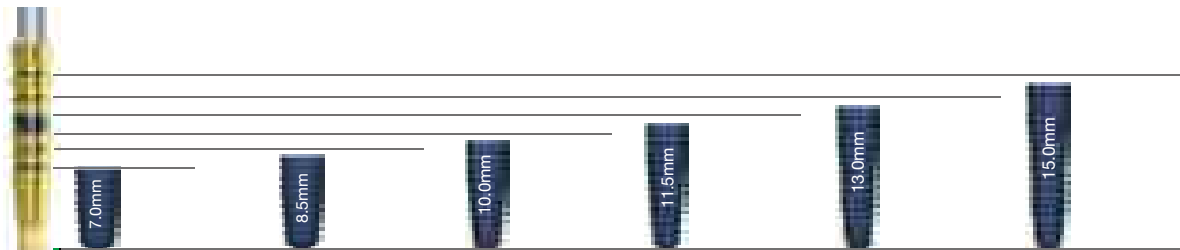

※ To place a Ø5.0 x 10mm length fixture, the required bone depth would be 10.89mm.
For example : 0.5mm(subcrestal concept) + 0.89mm(Y dimension of drill tip) + 9.5mm (fixture length)

Dense Drill

- To control initial stability in dense bone (type I & II), use the Dense Drill to remove and shape the cortical bone.

D2 Bone

In type II bone, drill to the first line.

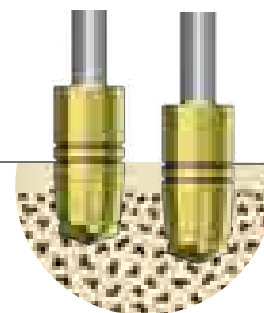

D1 Bone

In type I bone, drill to the second line.

► ► Surgical drilling sequence

- AnyOne fixtures offer optimum initial stability when they are used with the following drill sequence guide, AnyOne implants should be placed 0.5mm subcrestally.

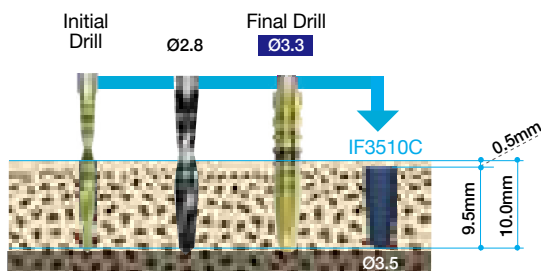

Ø3.5 Fixture

Ø3.5 drilling sequence

10.0mm is the fixture length, The Shaping Drills are 0.59mm longer than the fixture, so total drill depth is 10.59mm.

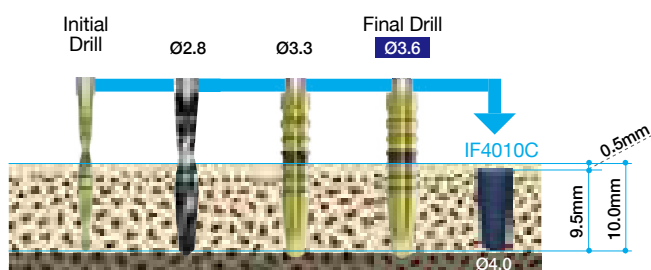

Ø4.0 Fixture

Ø4.0 drilling sequence

10.0mm is the fixture length, The Shaping Drills are 0.68mm longer than the fixture, so total drill depth is 10.68mm.

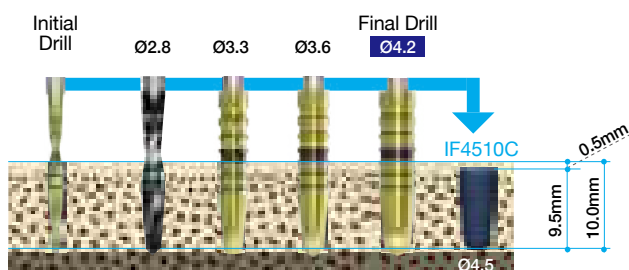

Ø4.5 Fixture

Ø4.5 drilling sequence

10.0mm is the fixture length, The Shaping Drills are 0.85mm longer than the fixture, so total drill depth is 10.85mm.

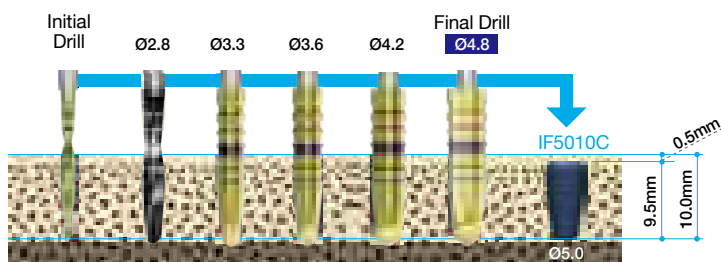

Ø5.0 Fixture
Ø5.0 drilling sequence

10.0mm is the fixture length, The Shaping Drills are 0.89mm longer than the fixture, so total drill depth is 10.89mm.

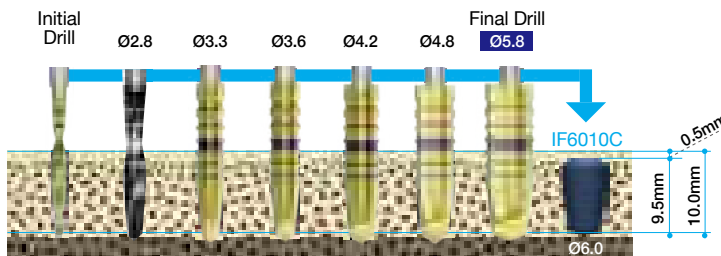

Ø6.0 Fixture
Ø6.0 drilling sequence

10.0mm is the fixture length, The Shaping Drills are 0.94mm longer than the fixture, so total drill depth is 10.94mm.

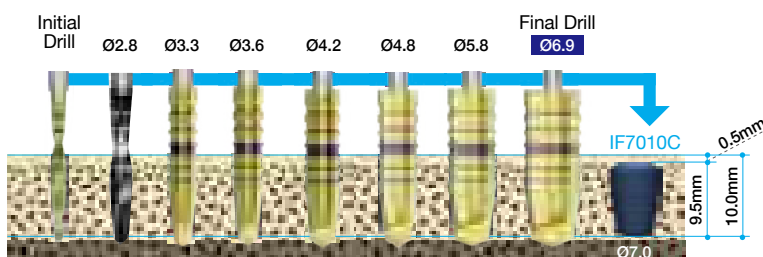

Ø7.0 Fixture
Ø7.0 drilling sequence

10.0mm is the fixture length, The Shaping Drills are 0.94mm longer than the fixture, so total drill depth is 10.94mm.

▶▶ Handpiece & Ratchet Connector

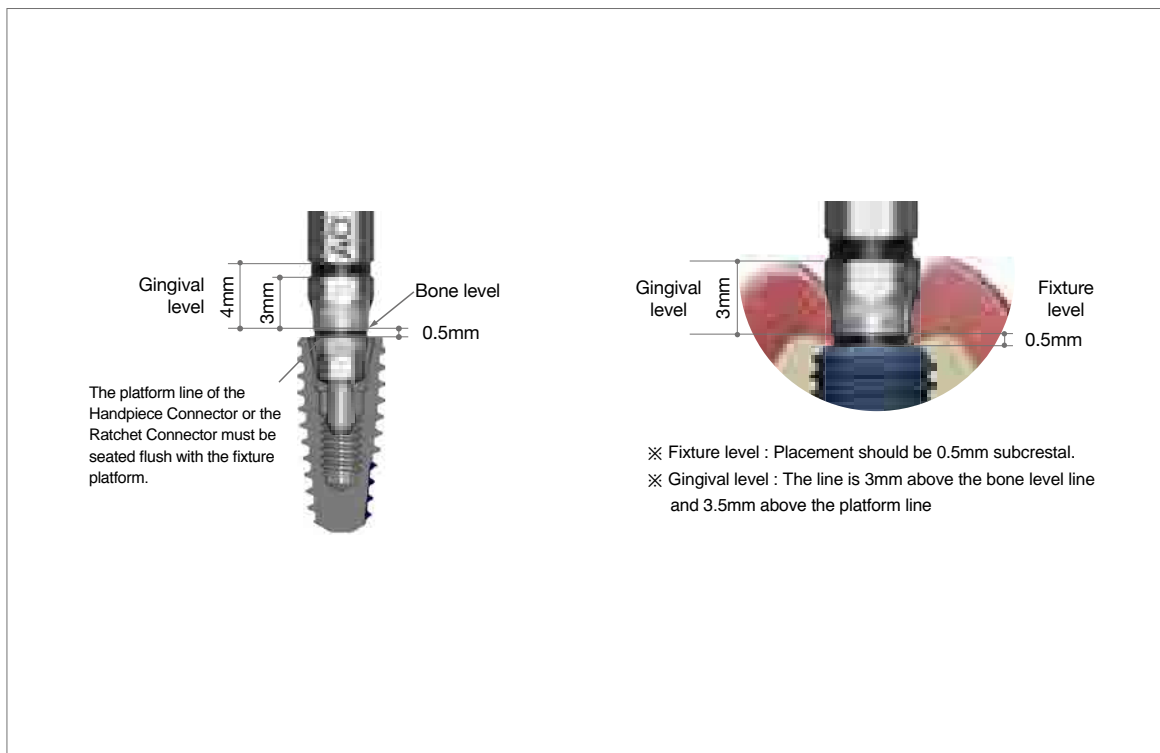

➔ Surgical Kit Components (Continued)

Initial Drill

- Used to pierce the cortical bone initially.
- Advisable to go into the bone to the full length of a fixture.

Diameter	Length(mm)	Ref.C
Ø1.8	33	ID1818S
	38	*ID1818M
	43	*ID1818L

(*) Separate sales item.



Shaping Drill

- Each drill has depth marking lines from 7.0mm to 15.0mm.
- The dual marking system(grooves and laser markings) provides visual and radiographic depth verification during surgery.
- TiN coating on drills : Enhanced corrosion resistance and abrasion resistance.

Diameter	Length(mm)	Ref.C
Ø2.0	33	SD2018S
	38	*SD2018M
	43	*SD2018L
Ø2.5	33	SD2518S
	38	*SD2518M
	43	*SD2518L
Ø2.8	33	SD2818S
	38	*SD2818M
	43	*SD2818L
Ø3.3	33	SD3318S
	38	*SD3318M
	43	*SD3318L
Ø3.6	33	SD3618S
	38	*SD3618M
	43	*SD3618L
Ø4.2	33	SD4218S
	38	*SD4218M
	43	*SD4218L
Ø4.8	33	SD4818S
	38	*SD4818M
	43	*SD4818L
Ø5.8	33	SD5818S
	38	*SD5818M
	43	*SD5818L
Ø6.9	33	SD6918S
	38	*SD6918M
	43	*SD6918L

(*) Separate sales item.

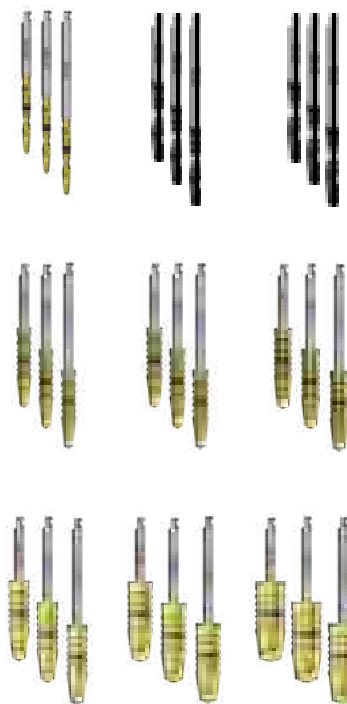

Dense Drill

- Used to remove and shape cortical bone to control initial stability in dense bone (type I & II).
- TiN coating on drills : Enhanced corrosion resistance and abrasion resistance.

Diameter	Type	Ref.C
Ø3.9	Long	DD39
Ø4.3		DD43
Ø4.8		DD48
Ø5.3		DD53
Ø6.3		DD63
Ø7.3		DD73

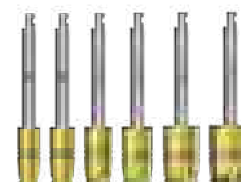

➔ Surgical Kit Components (Continued)

Handpiece Connector

- Used with Handpiece to remove fixture from ampule and to place the fixture.
- Spring type connection allows for easy and secure pick-up and positioning of the fixture.
- First mark on the shaft indicate the position of the fixture platform, For second mark, the bottom of the black line is 3mm and the top of the black line is 4mm(from fixture platform).
- Especially useful in flapless surgery.

AnyOne Internal& External

Length(mm)	Type	Connection	Ref.C
5	*Ultra-short	Hex. 2.5	HCU25
10	Short		HCS25
15	Long		HCL25

(*) Separate sales item

MiNi

Length(mm)	Type	Connection	Ref.C
10	Short	Hex. 1.7	HCS17
15	Long		HCL17

OneStage

Length(mm)	Type	Connection	Ref.C
6	*Ultra-short	Octa. 3.1	MTHC200U
9	Short		MTHC200S
16	Long		MTHC200L

(*) Separate sales item

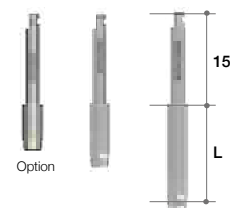
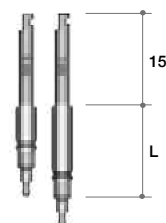
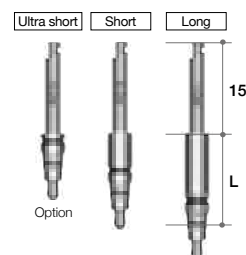

Ratchet Connector

- Used for inserting or removing a fixture with the Ratchet Wrench.
- Check to make sure the Ratchet Connector is completely seated into the Ratchet Wrench before using.
- Excessive force can cause damage to internal hex of fixture.
- Marks on the shaft indicate the position of fixture platform. Bottom of the black line is 3mm and top of black line is 4mm(from fixture platform).
- Especially useful in flapless surgery.

Internal& External

Length(mm)	Type	Connection	Ref.C
10	*Ultra-short	Hex. 2.5	RCU25
15	Short		RCS25
20	Long		RCL25

(*) Separate sales item

MiNi

Length(mm)	Type	Connection	Ref.C
15	Short	Hex. 1.7	RCS17
20	Long		RCL17

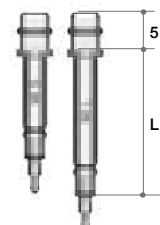
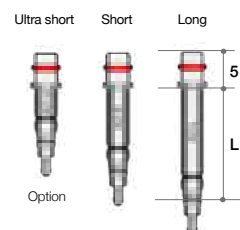

Final Driver

- Used to attach or remove the fixture by connecting to Ratchet Wrench
- Used to mount the Ratchet Connector fully on the Ratchet Wrench

OneStage

Length(mm)	Type	Connection	Ref.C
6	Short	Octa. 3.1	MOHD310S
13	Long		MOHD310

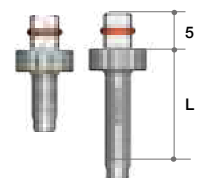

Hand Driver (1.2 Hex)

- Used for all Cover Screws, Abutment Screws, and Healing Abutments.
- Available in 4 lengths for added convenience.
- Hand Driver can be directly inserted into the Torque Wrench without using an adaptor.
- Hex tip can with stand 35-45Ncm of torque without distorting.

Length(mm)	Type	Ref.C
5	*Ultra-short	TCMHDU1200
10	Short	TCMHDS1200
15	Long	TCMHDL1200
20	*Extra-long	TCMHDE1200

(*) Separate sales item

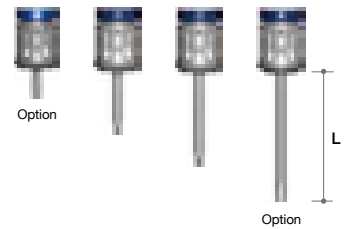

Hand Driver (0.9 Hex)

- Used for AnyOne External fixture cover screw.
- Available in 3 lengths for convenience.
- Hand Driver can be directly inserted in the to Torque Wrench without using an adaptor.
- Hex tip can with stand 25-35Ncm of torque without distorting.

Length(mm)	Type	Ref.C
5	*Ultra-short	TCMHDU0900
10	Short	TCMHDS0900
15	Long	TCMHDL0900

(*) Separate sales item

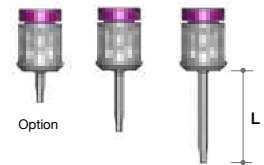

Drill Extension

- No more than 35Ncm torque : May distorted when excessive force is applied.
- Extends drills & other handpiece instruments.

Ref.C
MDE150



➔ Surgical Kit Components

Direction Indicator

- Confirms drilling direction and functions as a parallel guide for additional osteotomies.
- Each end of the Direction Indicator has a different diameter
 - Ø2.0 and Ø2.8.

Diameter	Ref.C
Ø2.0 / Ø2.8	MDI100

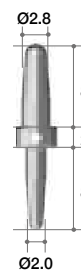

Path Finder

- After the fixture is placed, a Path Finder may be connected into the fixture and function as a parallel guide for additional osteotomies.
- Grooves indicate the distance from the fixture platform. The first groove is 0.3mm and the second groove is 1mm, especially useful in flapless surgery.

Length(mm)	Ref.C
15	PF

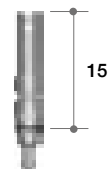

Ratchet Wrench

- Used to exert more force than the Handpiece.
- No bearing system : No breakage and no corrosion problems.
- Arrow laser marking indicates direction of force.

Ref.C
MRW040S



II. AnyOne Stopper Drill Kit

AnyOne Stopper Drill Kit helps to drill safely and conveniently to a desired depth.

Ref.C
KAOSS3000

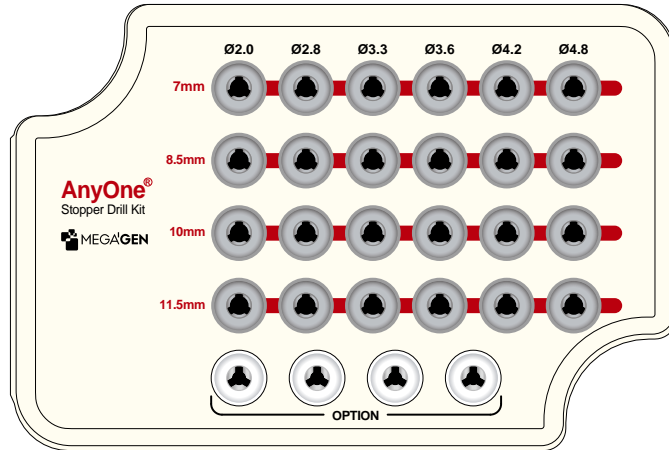

Stopper Drill

Diameter	Length(mm)	Ref.C
Ø2.0	7	SD2007M
	8.5	SD2008M
	10	SD2010M
	11.5	SD2011M
Ø2.8	7	SD2807M
	8.5	SD2808M
	10	SD2810M
	11.5	SD2811M
Ø3.3	7	SD3307M
	8.5	SD3308M
	10	SD3310M
	11.5	SD3311M
Ø3.6	7	SD3607M
	8.5	SD3608M
	10	SD3610M
	11.5	SD3611M
Ø4.2	7	SD4207M
	8.5	SD4208M
	10	SD4210M
	11.5	SD4211M
Ø4.8	7	SD4807M
	8.5	SD4808M
	10	SD4810M
	11.5	SD4811M
*Ø5.8	7	SD5807M
	8.5	SD5808M
	10	SD5810M
	11.5	SD5811M
*Ø6.9	7	SD6907M
	8.5	SD6908M
	10	SD6910M
	11.5	SD6911M

(*) Separate sales item.



III. AnyOne Prosthetic Kit Internal

Ref.C

KAOPK3000

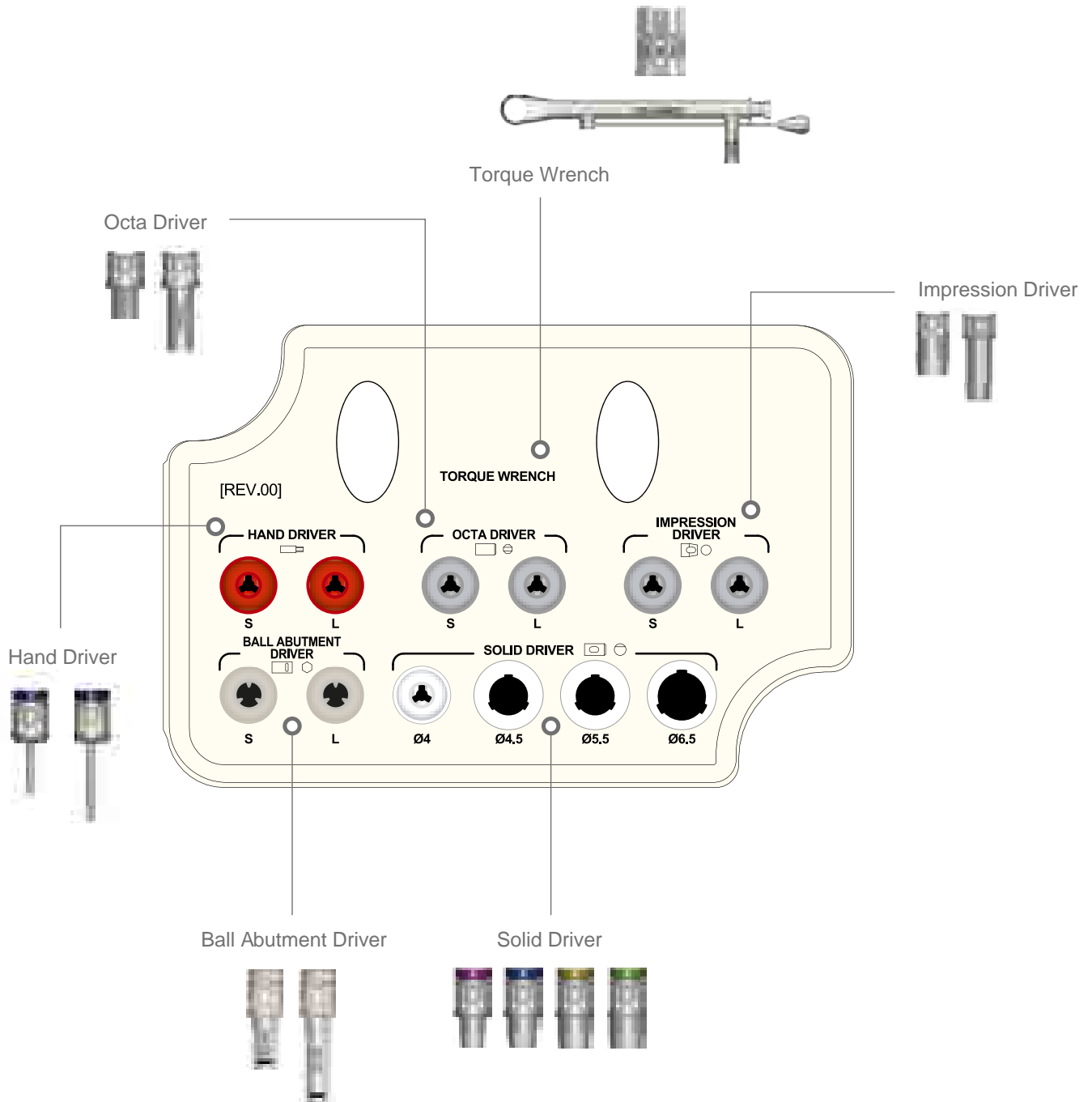

➔ Prosthetic kit Components

Solid Driver

- For seating the Solid Abutment into the fixture.
- Connected to Torque Wrench as well.
- Color coded for different profile diameters.
(Magenta : PD Ø4.0, Blue : PD Ø4.5, Yellow : PD Ø5.5, Green : PD Ø6.5)
- Two different lengths(6mm/ 12mm).

Diameter	Length(mm)	Type	Ref.C
Ø4.0	6	Short	SDS40
	12	Long	*SDL40
Ø4.5	6	Short	*SDS45
	12	Long	SDL45
Ø5.5	6	Short	SDS55
	12	Long	*SDL55
Ø6.5	6	Short	SDS65
	12	Long	*SDL65

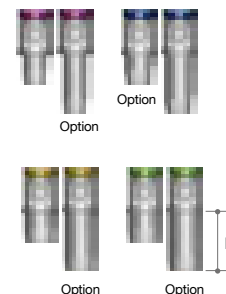

(*) Separate sales item.

Octa Driver

- For seating the Octa Abutment onto the fixture.
- Can also be connected to Torque Wrench.

Length(mm)	Ref.C
6	MOD300S
12	MOD300L

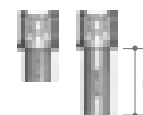

Ball Driver

- For seating the Ball Abutment into the fixture.
- Can connect to a Handpiece, Ratchet or Torque Wrench.
- Available in long or short.

Type	Ref.C
*Handpiece Connector(Short)	TBH250S
*Handpiece Connector(Long)	TBH250L
*Ratchet Extension(Short)	TBR250S
*Ratchet Extension(Long)	TBR250L
*Torque Driver(Short)	TBT250S
Torque Driver(Long)	TBT250L

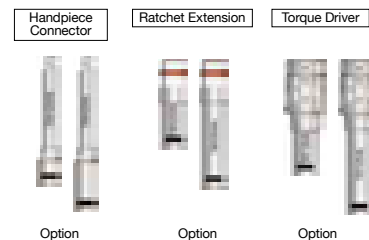

(*) Separate sales item.

Impression Coping Driver (Transfer)

- For transfer type of Impression Coping.
- Works with friction only.
- Small but powerful grip.

Type	Ref.C
For Two piece impression Coping	TCMID
For One piece impression Coping	TCMIDE

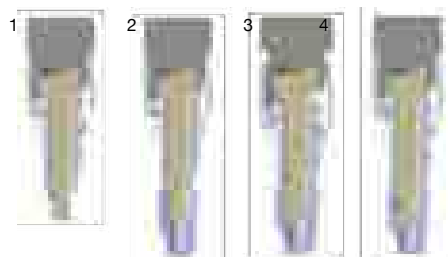

1. Connect Impression Coping and Impression Driver together
2. Adjust Connection with a Fixture by turning a Holder clockwise.
3. Push the Holder and put the Impression Coping into the Fixture.
4. Turn the Driver clockwise to ensure connection of the Impression Coping and Fixture.

IV. AnyOne Bone Profiler Kit

Ref.C
 KAOBP3000

Removes the overhanged bone around a fixture to allow adequate seating of a Healing Abutment or a Prosthetic Abutment.

- Place a Guide Pin into a fixture and choose a Bone Profiler which fits with the situation.
- Four different sizes of bone profiler and four guide pins are included in the kit.

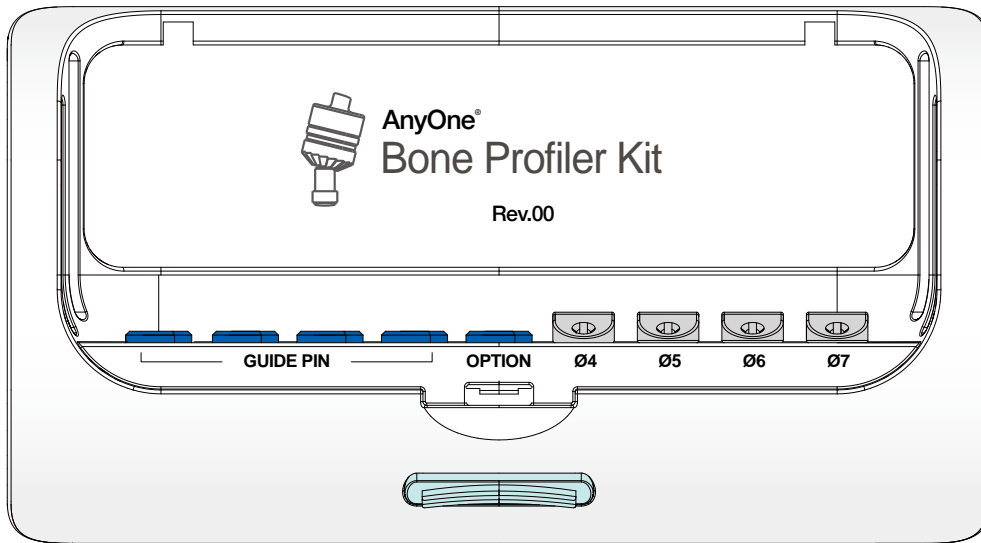

Bone Profiler

- Guide Pin(BPGP2) included.

- Each bone profiler can be purchased separately for refill.
- Each package includes a bone profiler and a guide pin.

Profile Diameter	Length (mm)	Ref.C
Ø4	13	AOBP40G
Ø5		AOBP50G
Ø6	8	AOBP60G
Ø7		AOBP70G

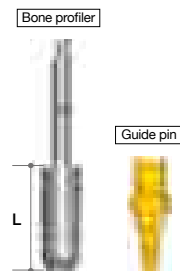

V. Optional components (Continued)

- not included in a surgical kit
- may be purchased separately and placed in the spaces provided in the surgical kit

Lindermann Drill

- Cross cut on the drill.
- Can correct the path during drilling.

Diameter(mm)	Ref.C
2	TEEL200M

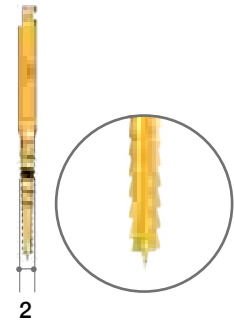

Hand Tap

- Useful when the internal screw of the Fixture has been damaged
- For Re-tapping the disabled thread
- It can even more damage the thread when excessive force is applied when Re-tapping. Therefore it is recommended to apply the force slowly and gradually
- M1.6 can be used for AnyOne's External fixtures with Small Sizes

Length(mm)	Type	Ref.C
10	M1.6	THT160L
	M2.0	THT200L

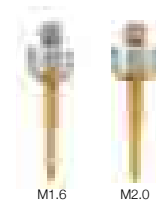

V. Optional components (Continued)

Tissue Punch

- Customized to remove soft tissue using osteotomy socket and useful for flapless surgery
- Easy to identify the thickness of soft tissue by comparing the tissue with the laser marking on the height of 2mm
- Can minimize the loss of soft tissue when conducting a flapless surgery
- Can stop from bleeding when used with Healing Abutment

Diameter	Marking	Ref.C
In. Ø3 / Out. Ø4	2mm	TCMTPM0304
In. Ø4 / Out. Ø5		TCMTPM0405
In. Ø5 / Out. Ø6		TCMTPM0506
In. Ø6 / Out. Ø7		TCMTPM0607
In. Ø7 / Out. Ø8		TCMTPM0708

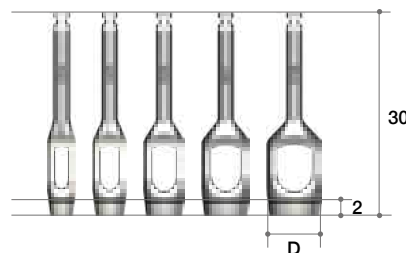

Flattening Drill

- Flattens the irregular bone and enables the stopper drill to drill the exact depth
- Designed to be engaged with Flattening Lance and Housing. There are 2 kinds of Housing to match the diameters of different final drills. (Ø5.0 & Ø6.0)
- Ø5.0 = Stopper Drill Ø2.0 ~ Ø4.3
- Ø6.0 = Stopper Drill Ø4.8 ~ Ø5.4
- By using Housing Boundary of the path is formed and it becomes the barometer of the drilling position for the next fixture

Diameter	Length(mm)	Ref.C
Ø5.0 / Ø2.0	3.5	FD5020
Ø6.0 / Ø2.0		FD6020

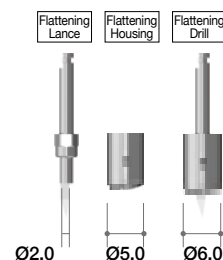

1

• Use Flattening Drill to make drilling on the right fixture position
(If the Final drill's diameter is from Ø2.0~Ø4.3, use Ø5.0 Housing and in case the diameter is Ø4.8, Ø5.4 use Ø6 Housing.)

2

• Start drilling sequence below considering the size of fixtures to place and the bone density

3

• Start placing the fixtures using Handpiece & Ratchet Connector

Trepine Bur

- Minimizes the drilling steps needed, especially for wider fixtures.
- Helpful for collecting autogenous bone.
- Useful for removing failed and fractured fixtures.
- Depth markings are 7, 8.5, 10, 11.5, 13mm, same depths as fixtures. (No Y dimension so markings are actual length).
- Markings on the drill shaft represent the inside / outside diameter of Trepine Burs.

Diameter	Type	Ref.C
Ø3.5 (in Ø2.5)	Short (32mm)	TANTBL2535
Ø5.0 (in Ø4.0)		TANTBL4050
Ø6.0 (in Ø5.0)		TANTBL5060
Ø7.0 (in Ø6.0)		TANTBL6070
Ø3.5 (in Ø2.5)		TANTBE2535
Ø5.0 (in Ø4.0)	Long (38mm)	TANTBE4050
Ø6.0 (in Ø5.0)		TANTBE5060
Ø7.0 (in Ø6.0)		TANTBE6070

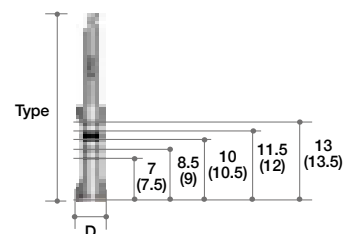

Trepine Bur Stopper

- Controls the depth of trephination with a Stopper placed into the Trepine.
- Especially useful in cases with limited available bone from important anatomy.

Length (mm)	Ref.C
7.0	TANTSF2307
8.5	TANTSF2308
10.0	TANTSF2310
11.5	TANTSF2311

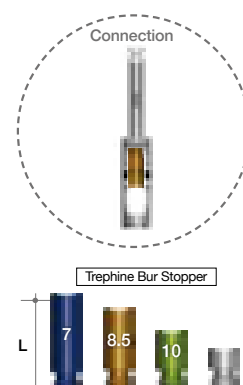

Bottom Drill

- It removes remaining bone in osteotomy socket after trephine drilling.
- It imprints the sizes of fixtures, for example 7, 8.5, 10, 11.5 and 13mm, by laser marker.

Diameter	Type	Ref.C
Ø3.3	Short (32mm)	TCMBDS33
Ø3.8		TCMBDS38
Ø4.8		TCMBDS48
Ø5.8		TCMBDS58
Ø6.8		TCMBDS68
Ø3.3	Long (38mm)	TCMBDL33
Ø3.8		TCMBDL38
Ø4.8		TCMBDL48
Ø5.8		TCMBDL58
Ø6.8		TCMBDL68

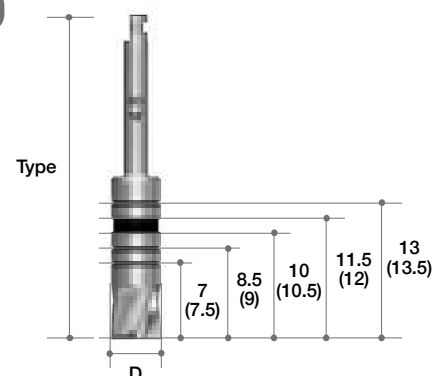

V. Optional components (Continued)

Reamer Drill & Center Pin

- Removes inner lip of the cast after casting Burn-out Cylinders of Solid Abutment.
- Center Pin have 4 different diameters according to the profile diameter of Solid Abutments.

Diameter	Type	Ref.C
Ø10.0	Reamer Drill	TANRD
Ø4.0	Center Pin	RDJ40
Ø4.5		RDJ45
Ø5.5		RDJ55
Ø6.5		RDJ65

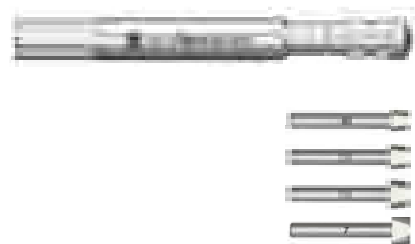

Slot Driver (Slotted type)

- Useful for the placement or removal of AnyOne Healing Abutment which has slot on the top.

Length(mm)	Type	Ref.C
10	Short	SDS06
15	Middle	SDM06
20	Long	SDL06

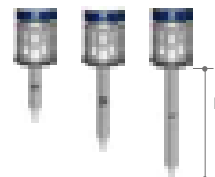

Multi-unit Driver (2.0 Hex) (For Multi-unit Abutment)

- For the seating & tightening of Multi-unit Abutment (Straight type)

Length(mm)	Type	Ref.C
10	Short	TCMMUDS20
15	Long	TCMMUDL20



Tap Drill

- Can use both Handpiece(Dental implant engine) & Ratchet Wrench

Diameter	Marking	Ref.C
Ø3.9	7/ 8.5/ 10/ 11.5/ 13/ 15	TD35
Ø4.3		TD40
Ø4.8		TD45
Ø5.3		TD50
Ø6.3		TD60
Ø7.3		TD70

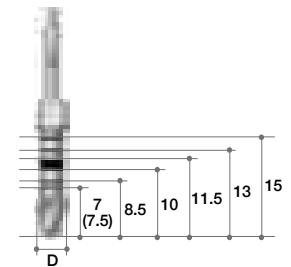

Torque Wrench & Adapter

- Torque Wrench has various options to control the force from 15Ncm ~ 45Ncm and can be used for engaging with Abutment Screw

Type	Ref.C
Torque Wrench	MTW300AT
*Right Angle Adapter (Handpiece)	TTAI100
Torque Wrench Adapter (Ratchet)	TTAR100

(*) Separate sales item.

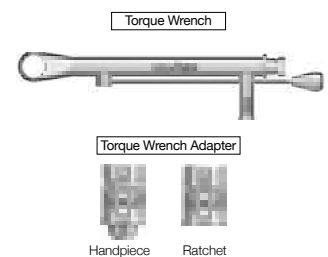

Mount Removal Driver

Length(mm)	Ref.C
19	MVD100

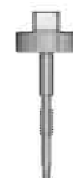

R2GATE Full Surgical KIT

I. R2GATE Full Surgical Kit for AnyOne System

- If you only use a specific system, corresponding system's full kit can be provided.
- R2GATE full surgical kit is composed with all of drills and components that are needed for the Digital Guided Surgery which uses R2GATE Guide™ after R2GATE® diagnosis. It helps to actualize minimally invasive surgery and makes exact clinical result as the diagnosis.

Ref.C
KAGIN3001

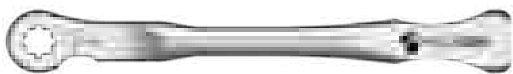

Initial Drill

Initial Drill



Second Drill



Drilling to make the initial drill path

Cortical Bone Drill



In type I or II bone, crestal bone is partly reduced to lower the pressure against the fixture during placement.

RATCHET WRENCH

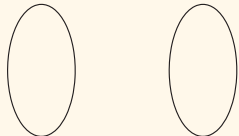

AnyOne ANYGUIDER2

CORTICAL DRILL

	Ø2.0	Ø2.5	Ø2.8	Ø3.3	Ø3.6
13mm					
11.5mm					
10mm					
8.5mm					
7mm					

INIAL DRILL

SECOND DRILL

DRILL EXTENSION

Ø3.5

Ø4.0

Guide Stop Drill

Drill diameter : Ø2.0 ~ Ø 5.9
Drill Length : 7.0 ~ 13.0mm



Guide length : 13.5mm
Drilling length : 7.0 ~ 13.0mm

Drill Extension



Bone Profiler



This is used to minimize the interference of the crestal bone when connecting ZrGEN Abutment. [Used before placing the fixture / Recommended RPM 600 ~1000]

Implant Carrier

: Handpiece type
: Ratchet type

► R – AnyOne Regular (ø3.5 ~ø4.5)

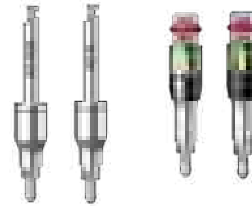

► W – AnyOne Wide (ø5.0 ~ ø6.0)

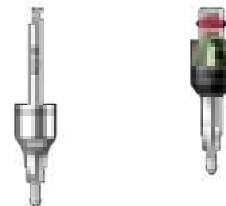

Ø4.0 Ø5.0 Ø6.0

BONE PROFILER

Ø4.5 Ø5.0 Ø6.0 Ø3.5

IMPLANT CARRIER

HANDPIECE ADAPTER **RATCHET EXTENSION**

S L

HAND DRIVER

OPTION

Ø4.2 Ø4.8 Ø5.8

Ø4.5 Ø5.0 Ø6.0



Hand Driver : 1.2 hex driver (Short/Long)

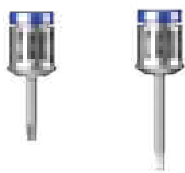

Carrier-Handpiece Adapter



Carrier Extension



➔ Components for R2GATE Full Surgical Kit (Continued)

- If you only use a specific system, corresponding system's full kit can be provided.
- R2GATE full surgical kit is composed with all of drills and components that are needed for the Digital Guided Surgery which uses R2GATE Guide™ after R2GATE® diagnosis. It helps to actualize minimally invasive surgery and makes exact clinical result as the diagnosis.

Initial Drill

- Use the initial drill in order to mark the drilling position on the bone. Start drilling slowly, when drill guide part is fully contacted with drilling core of R2GATE Guide™.
- Recommended drilling speed range is 300 ~ 800 RPM with copious irrigation.

Diameter	Guide Diameter	Length(mm)	Ref.C
Ø2.6	Ø5.0	1.0	R2ID2601

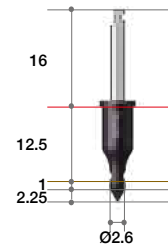

Second Drill

- This unique step-drill(from Ø2.0 to Ø4.6) is used to flare out the upper cortical bone of the osteotomy.
- It helps not only the rest drilling procedure but abut- ment connection. In case of hard bone, if the 2nd drilling will be disturbed by thick cortical bone. Stop the drilling and try it after final drilling procedure.

Diameter	Guide Diameter	Length(mm)	Ref.C
Ø2.5	Ø5.0	5.0	R2SD2505

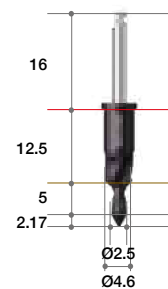

Stopper Drill

- Universal drills consist of Ø2.0, Ø2.5, Ø2.8 diameter to enlarge the osteotomy gradually.
- The length of drill are designed as 7.0, 8.5, 10, 11.5, 13mm for most common length of implant system.
- Recommended drilling speed range is 500 ~ 800 RPM with copious irrigation.

Diameter	Guide Diameter	Length(mm)	Ref.C
Ø2.0	Ø5.0	6.5	AGSD2007
		8.0	AGSD2008
		9.5	AGSD2010
		11.0	AGSD2011
		12.5	AGSD2013
Ø2.5		6.5	AGSD2507
		8.0	AGSD2508
		9.5	AGSD2510
		11.0	AGSD2511
		12.5	AGSD2513
Ø2.8		6.5	AGSD2807
		8.0	AGSD2808
		9.5	AGSD2810
		11.0	AGSD2811
		12.5	AGSD2813

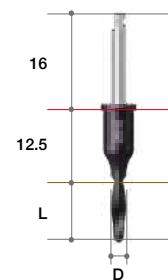

Bone Profiler

- Recommended drilling speed is 300 ~ 800 RPM.

Diameter	Guide Diameter	Ref.C
Ø4.0	Ø5.0	AGBP40
Ø5.0		AGBP50
Ø6.0		AGBP60

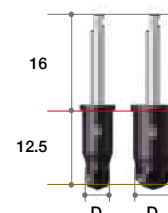

Stopper Drill

• Recommended drilling speed is 300 ~ 800 RPM.

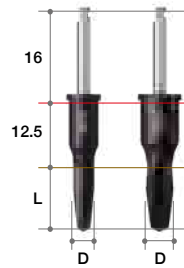

Diameter	Guide Diameter	Length(mm)	Ref.C
Ø3.3	Ø5.0	7.0	AOSD3307
		8.0	AOSD3308
		9.5.0	AOSD3310
		11.0	AOSD3311
		12.5	AOSD3313
Ø3.6	Ø5.0	7.0	AOSD3607
		8.0	AOSD3608
		9.5	AOSD3610
		11.0	AOSD3611
		12.5	AOSD3613
Ø4.2	Ø5.0	7.0	AOSD4207
		8.0	AOSD4208
		9.5	AOSD4210
		11.0	AOSD4211
		12.5	AOSD4213

Diameter	Guide Diameter	Length(mm)	Ref.C
Ø4.8	Ø6.5	7.0	AOSD4807
		8.0	AOSD4808
		9.5	AOSD4810
		11.0	AOSD4811
Ø5.8	Ø6.5	12.5	AOSD4813
		7.0	AOSD5807
		8.0	AOSD5808
		9.5	AOSD5810
		11.0	AOSD5811
		12.5	AOSD5813

➔ Components for R2GATE Full Surgical Kit (Continued)

Cortical Bone Drill

- Recommended drilling speed : 300 ~ 800 RPM

Diameter	Guide Diameter	Length(mm)	Ref.C
Ø3.9	Ø5.0	6.0	AODD39
Ø4.3			AODD43
Ø4.8			AODD48
Ø5.3	Ø6.5	5.5	AODD53
Ø6.3			AODD63

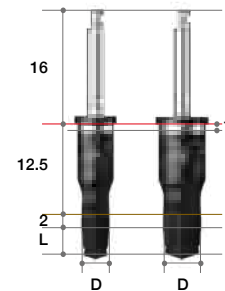

Implant Carrier

- Two different implant carriers for regular stent since Ø3.5 fixture has different abut- ment connection
- To pick up the fixture from the ampule and insert it to the ossetomy. Then turn it to clock-wise direction 2~3 times manually.
- When it gets fixation from the osteotomy, connect the handpiece adaptor and use implant motor.
- Recommended insertion torque is 45~50Ncm.

Connection	Guide Diameter	Type	Ref.C
2.3 Hex	Ø5.0	Ratchet	ICRH2518
			ICRH2523
	Ø6.5	Handpiece	ICWH2523
	Ø5.0		ICRH2518H
			ICRH2523H
	Ø6.5		ICWH2523H

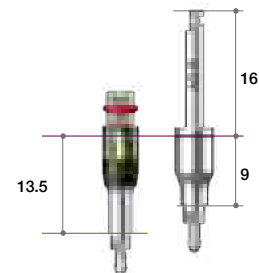

Carrier-Handpiece Adapter

- Useful to use the handpiece for the implant placement following initial delivery of a fixture with a fixture carrier.

Diameter	Ref.C
5.0	AGHA

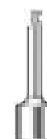

Carrier Extension

- To extend the length of implant carrier.

Diameter	Ref.C
4.0	MRE400S



Drill Extension

- No more than 35Ncm torque : May distorted when excessive force is applied.
- Extends drills & other handpiece instruments.

Ref.C

MDE150



Hand Driver (1.2 Hex)

- Used for all Cover Screws, Abutment Screws, and Healing Abutments.
- Available in 4 lengths for added convenience.
- Hand Driver can be directly inserted into the Torque Wrench without using an adaptor.
- Hex tip can with stand 35-45Ncm of torque without distorting.

Length(mm)	Type	Ref.C
5.0	*Ultra-short	TCMHDU1200
10	Short	TCMHDS1200
15	Long	TCMHDL1200
20	*Extra-long	TCMHDE1200

(*) Separate sales item.

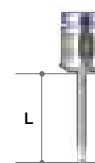

Ratchet Wrench

- Used to exert more force than the Handpiece.
- No bearing system : No breakage and no corrosion problems.
- Arrow laser marking indicates direction of force.

Ref.C

MRW040S



R2GATE Universal Kit

Maximize the cost-effectiveness & efficiency.

Ref.C
KAGUN3000

When you want to do R2GATE surgery with R2GATE Guide™, Please inform us your favorite implant system

Make your own R2GATE Surgical Kit with your favorite implant system. R2GATE Universal kit consists of basic drilling set which can be used for any implant system. You can add system options as "Implant Carrier", "Cortical Bone Drill", "Tap Drill" to your favorite implant system. The specification of final drills will be decided with treatment planning and delivered to you with R2GATE Guide™ will be from the R2GATE Design Center.

Universal Kit
Consisted of basic drilling set which can be used for any implant system



Customized instrument for various implant system

AryRidge / AryRidge Octa 1 / AnyOne Mini / ST BoneLevel(Straumann) / Nobel Active(Nobel Biocare) / SuperLine(Dentium) / TSIII(Osstem)
(Available system can be varied by country due to registration process)



Intermediate & final drill will be delivered with R2GATE Guide™



➔ R2GATE Universal Kit

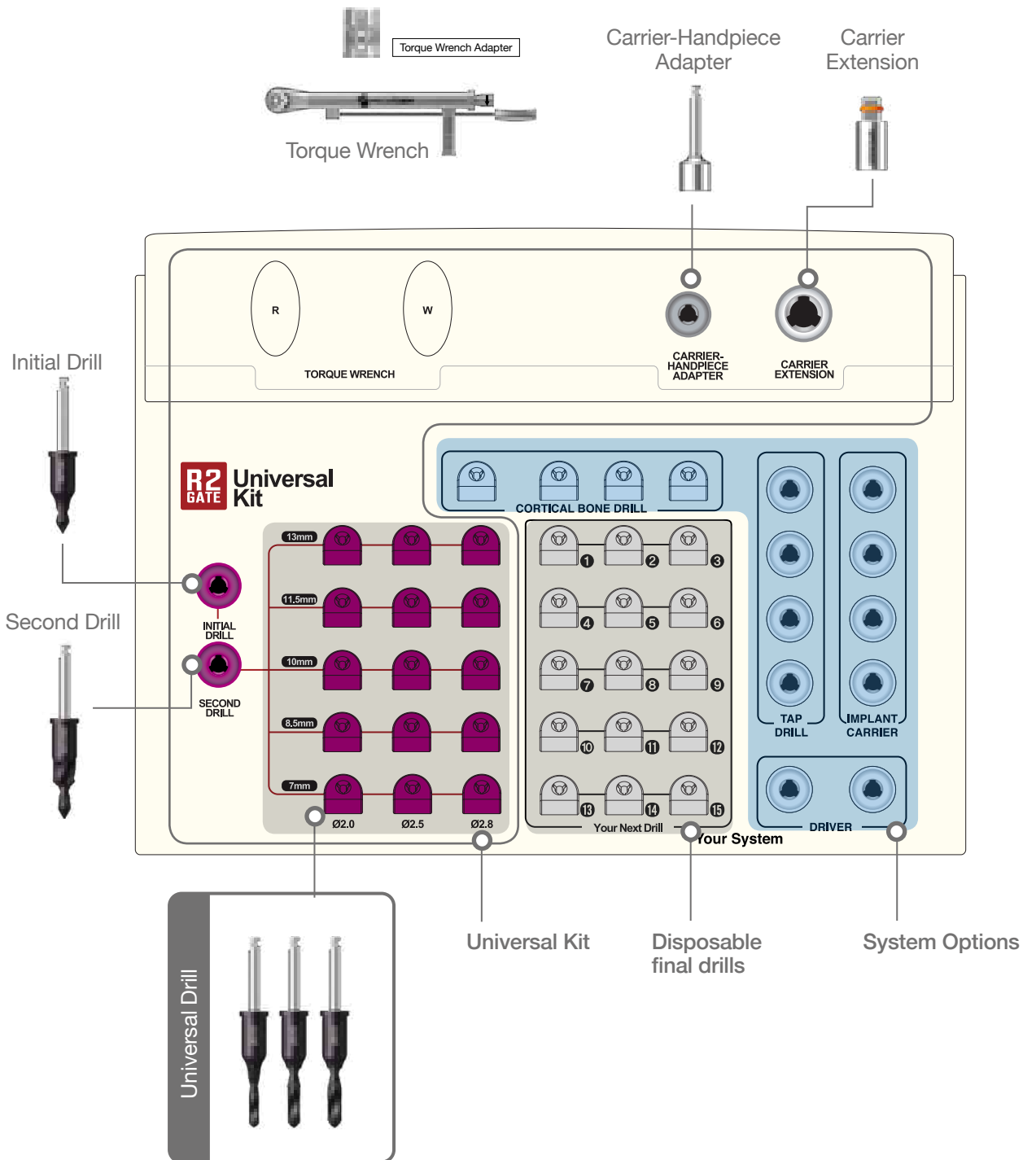

➔ Drills & Components for R2GATE Universal Kit

Basic drilling set for any implant system. It consists of initial drill, 2nd drill, universal drills and essential tools.

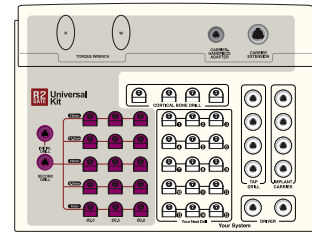

Initial Drill

- Use the initial drill in order to mark the drilling position on the bone. Start drilling slowly, when drill guide part is fully contacted with drilling core of R2GATE Guide™.
- Recommended drilling speed range is 300 ~ 800 RPM with copious irrigation.

Diameter	Guide Diameter	Length(mm)	Ref.C
Ø2.6	Ø5.0	1.0	R2ID2601

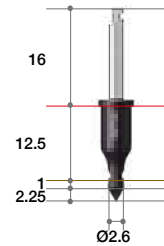

Second Drill

- This unique step-drill(from ø2.0 to ø4.6) is used to flare out the upper cortical bone of the osseotomy.
- It helps not only the rest drilling procedure but abutment connection. In case of hard bone, if the 2nd drilling will be disturbed by thick cortical bone. Stop the drilling and try it after final drilling procedure.

Diameter	Guide Diameter	Length(mm)	Ref.C
Ø2.5	Ø5.0	5.0	R2SD2505

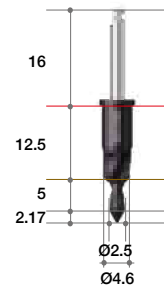

Stopper Drill

- Universal drills consist of ø2.0, ø2.5, ø2.8 diameter to enlarge the osteotomy gradually.
- The length of drill are designed as 7.0, 8.5, 10, 11.5, 13mm for most common length of implant system.
- Recommended drilling speed range is 500 ~ 800 RPM with copious irrigation.

Diameter	Guide Diameter	Length(mm)	Ref.C
Ø2.0	Ø5.0	6.5	R2SD2007
		8.0	R2SD2008
		9.5	R2SD2010
		11.0	R2SD2011
		12.5	R2SD2013
Ø2.5		6.5	R2SD2507
		8.0	R2SD2508
		9.5	R2SD2510
		11.0	R2SD2511
		12.5	R2SD2513
Ø2.8		6.5	R2SD2807
		8.0	R2SD2808
		9.5	R2SD2810
		11.0	R2SD2811
		12.5	R2SD2813

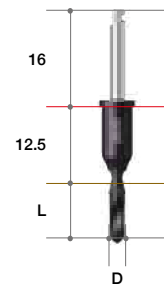

Carrier-Handpiece Adapter

- Useful to use the handpiece for the implant placement following initial delivery of a fixture with a fixture carrier ratchet type.

Square	Ref.C
4.0	AGHA



Carrier Extension

- To extend the length of implant carrier.

Square	Ref.C
4.0	MRE400S

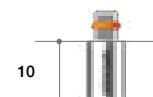

Torque Wrench & Adapter

- Torque Wrench has torque options from 15Ncm to 45Ncm and is used for the placement of an implant and final tightening of the Abutment Screw.

Type	Ref.C
Torque Wrench	TW70
Torque Wrench Adapter(Ratchet)	TTAR100



Optional Instrument

Narrow Crest Drill

- It is used when fixture will be slantly implanted or to flat the sloped bone surface of narrow ridge to prevent any slips during drilling.
- Design as 2-piece: drill body and housing
- Can be disassembled. Easy to clean and remove bone chips
- Can harvest autogenous bone if it is used after soft tissue

Diameter	Guide Diameter	Length(mm)	Ref.C
Ø4.0	Ø5.0	15.5(12.5/2)	NCD402

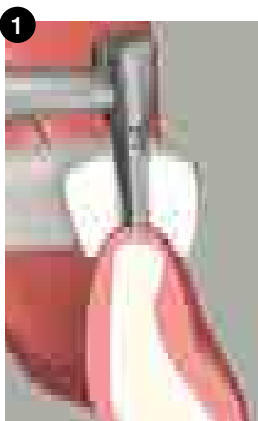
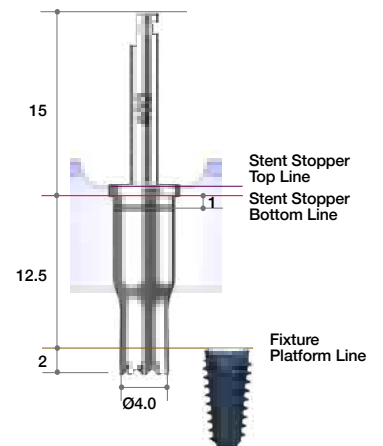
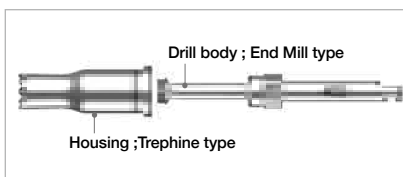

1 Set the site by drilling counter-clockwisely with low speed ($\leq 100\text{rpm}$)

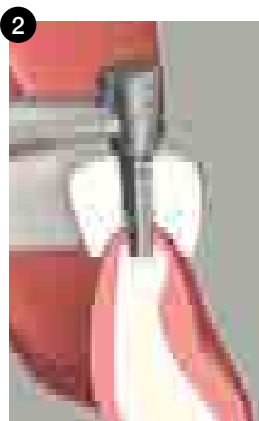

2 Start drilling clockwisely (400~600rpm)



3 Bone is now flat. Perform drilling with proper drilling sequence.

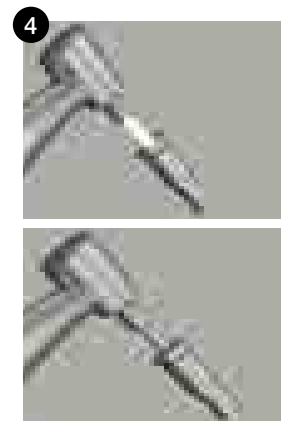

4 Disassemble body and housing after drilling to remove bone chip. Clean and sterilize after every usage.

➔ Final Drill Option [Disposable or Permanent]

Stopper Drill[Straight]

For all implant system

- Common use
- Step back type drilling
- Provided from local R2GATE Design Center to users. The size of disposable drills are decided depend size on treatment planning regarding to fixture size and bone density of patient.
- Recommended drilling speed is 300 ~ 800 RPM.
- Final drill.
- The base is disposable and can be made for permanent under your order

Diameter	Guide Diameter	Length(mm)	Permanent Ref.C	Disposal Ref.C
Ø3.4		7.0	R2PS3407	R2DS3407
		8.0	R2PS3408	R2DS3408
		9.0	R2PS3409	R2DS3409
		10.0	R2PS3410	R2DS3410
		11.0	R2PS3411	R2DS3411
		12.0	R2PS3412	R2DS3412
Ø3.8	Ø5.0	7.0	R2PS3807	R2DS3807
		8.0	R2PS3808	R2DS3808
		9.0	R2PS3809	R2DS3809
		10.0	R2PS3810	R2DS3810
		11.0	R2PS3811	R2DS3811
		12.0	R2PS3812	R2DS3812
Ø4.3		7.0	R2PS4307	R2DS4307
		8.0	R2PS4308	R2DS4308
		9.0	R2PS4309	R2DS4309
		10.0	R2PS4310	R2DS4310
		11.0	R2PS4311	R2DS4311
		12.0	R2PS4312	R2DS4312
Ø4.8		7.0	R2PS4807	R2DS4807
		8.0	R2PS4808	R2DS4808
		9.0	R2PS4809	R2DS4809
		10.0	R2PS4810	R2DS4810
		11.0	R2PS4811	R2DS4811
		12.0	R2PS4812	R2DS4812
Ø5.3	Ø6.5	7.0	R2PS5307	R2DS5307
		8.0	R2PS5308	R2DS5308
		9.0	R2PS5309	R2DS5309
		10.0	R2PS5310	R2DS5310
		11.0	R2PS5311	R2DS5311
		12.0	R2PS5312	R2DS5312
Ø5.8		7.0	R2PS5807	R2DS5807
		8.0	R2PS5808	R2DS5808
		9.0	R2PS5809	R2DS5809
		10.0	R2PS5810	R2DS5810
		11.0	R2PS5811	R2DS5811
		12.0	R2PS5812	R2DS5812
		13/0	R2PS5813	R2DS5813

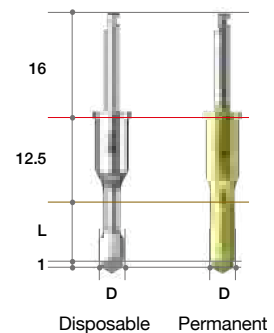

Drill position on the kit

- Every disposable drills have the numbering system to clarify it's own position on the universal kit.
- Check the drill size and position number, then install it to the right position.

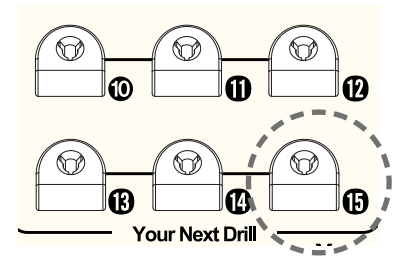
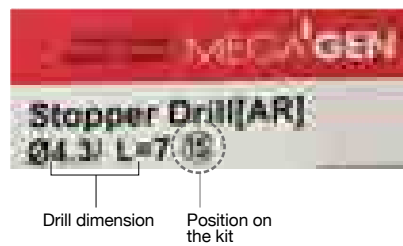

Sterilized package

- All disposable drills are packaged at clean room and sterilized by "Gamma-ray".
- Check the "Sterilized" seal on the package and open it at the operation site before surgery.



Digital Material

I. ZrGEN®

ZrGEN® is the brand name of MegaGen Titanium Base. ZrGEN provides an aesthetic outcome and simplified dental implant prosthesis. A ZrGEN® crown and monolithic crown connected to a ZrGEN® Abutment provide strong and precise connection with the implant fixture.

Variety of ZrGEN®



ZrGEN® Sub Structure



ZrGEN®

The strength of ZrGEN® frees you from the chipping of conventional PFM prosthesis. Monolithic zirconia crowns have no metal substructure, ensuring more aesthetic results. ZrGEN® crown and bridge are a superior substitutes for all conventional dental materials.

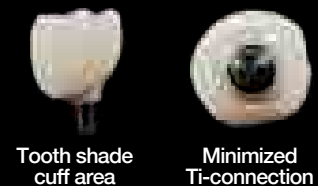

Clinical Application

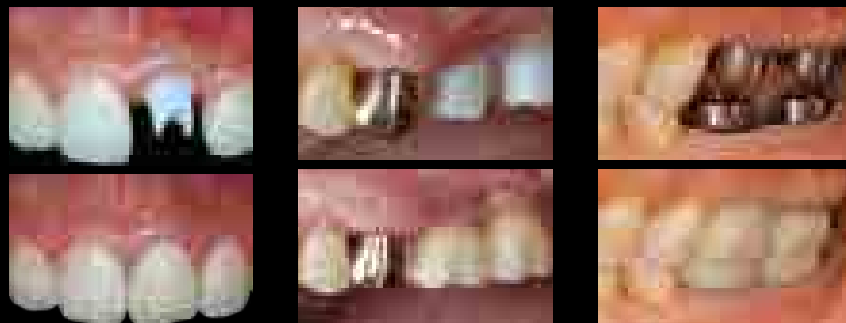

II. TiGEN®

TiGEN® is the brand name of MegaGen Titanium customized abutment. It promises outstanding durability and simplified dental implant prosthesis. Ready-made connection part provides a strong and precise connection with the implant fixture.



➔ ZrGEN® Prosthesis



ZrGEN Abutment

ZrGEN® Abutment

ZrGEN® Abutment provides a strong and precise connection with the implant fixture. With Zirconia® coping, crown margins can be placed supragingivally since zirconia material matches with the color of natural teeth. Residual cement problems are no longer an issue.

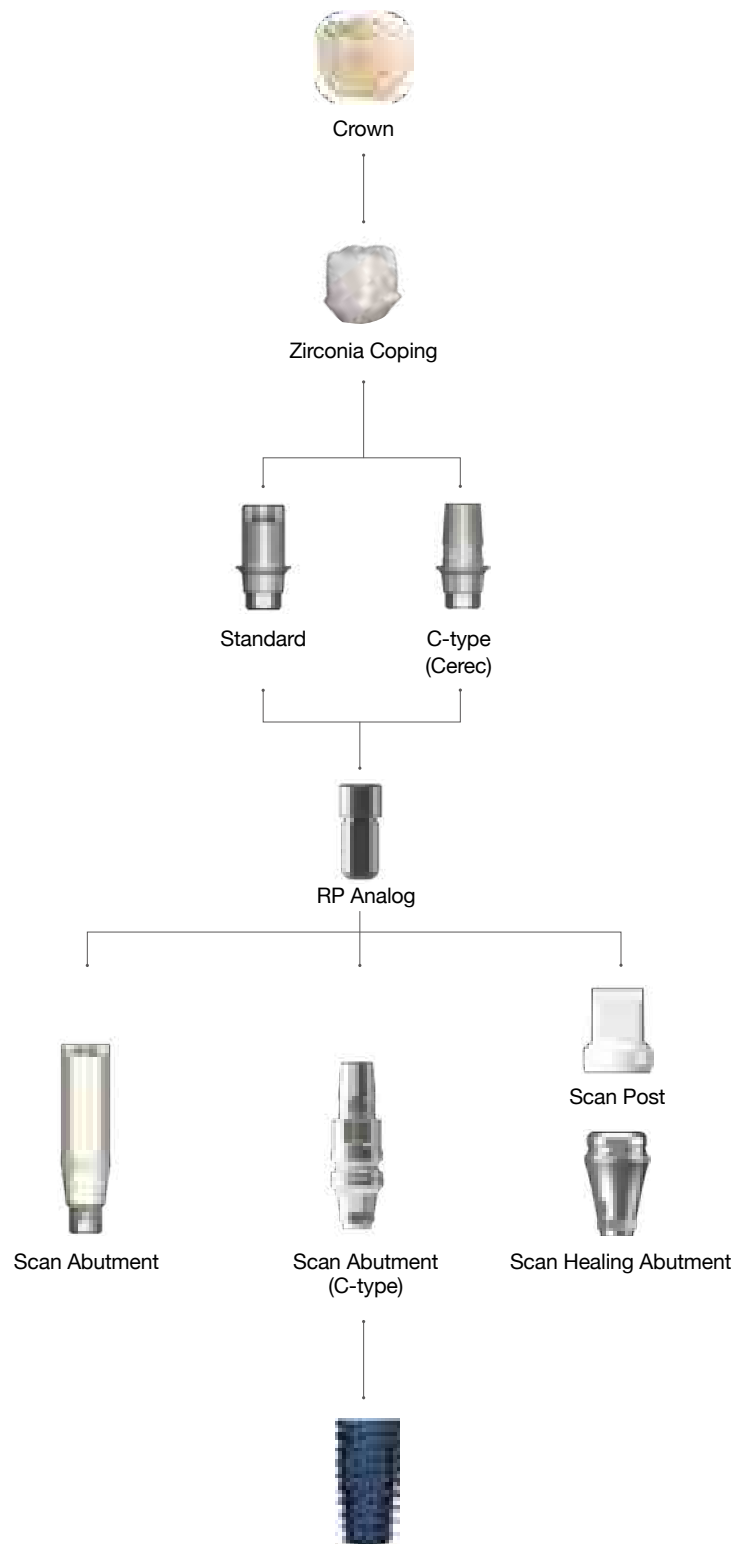

➔ Scan Abutment Option

Scan Abutment

- Abutment Screw included.
- . AnyRidge (AANMSF)
- . AnyRidge Octa 1 (AROAS16B/ AROAS16)
- . AnyOne Internal (AS20)
- . AnyOne Exeternal (SCS160/ RCS200)
- . AnyOne OneStage (EXIMS100)
- . MiNi (MIAS14)
- . ST (OSGSAS3110/ OSGSAS3210)
- . Octa Level (IRCS200)
- . Multi-unit Abutment (MUAS)

- For Chairside/ Labside
- Included spare Abutment Screw
- Supporting Dental CAD
 - 3 Shape
 - Exocad
 - Dental Wings

System	Profile Diameter	Length (mm)	Type	Ref.C
AnyRidge	Ø4.0	9	-	AANISR4009T
		13	-	AANISR4013T
AnyRidge Octa 1	Ø4.0	13	NC	AROSANT
			RC	AROSART
AnyOne Internal	Ø4.0	9	-	AAOISR4009T
		13	-	AAOISR4013T
AnyOne External	Ø4.0	9	Small	AEXESS4009T
			Regular	AEXESS4013T
		13	Regular	AEXESR4009T
AnyOne OneStage	Ø4.0	13	Cuff 1.8	AEXISR4010T
MiNi	3.5	9	-	MISS3509T
		13	-	MISS3513T
ST	Ø4.0	9	Small	OSGSSC3110T
			Regular	OSGSSC3111T
		13	Small	OSGSSC3210T
			Regular	OSGSSC3211T
Octa Level	Ø4.0	11	-	AOCESC4011T
MUA Level (N-Type)	Ø4.0	13	-	AMUASR4013T



Scan Abutmet (C-type)

- Abutment Screw included.
- . AnyRidge (AANMSF)
- . AnyOne (AS20)
- . AnyRidge Octa 1 (AROAS16B/ AROAS16)

- Scan Post for Sirona Cerec users → CEREC
- In in Lab CAD Software, compatible with
- Xive Library

System	Profile Diameter	Cuff Height	Post Size	Ref.C
AnyRidge	Ø3.9	0.5	Small	ARICSS3405T
		1		ARICSS3410T
		2		ARICSS3420T
	Ø4.3	0.5	Small	ARICSS3805T
		1		ARICSS3810T
		2		ARICSS3820T
Ø5.5	0.5	Large	ARICSL4505T	
	1		ARICSL4510T	
	2		ARICSL4520T	
AnyRidge Octa 1	Ø3.9	0.5	Small	AROCSS3405NT
		1		AROCSS3410NT
		2		AROCSS3420NT
	Ø4.3	0.5	Small	AROCSS3805NT
		1		AROCSS3810NT
		2		AROCSS3820NT
	Ø3.9	0.5	Small	AROCSS3405RT
		1		AROCSS3410RT
		2		AROCSS3420RT
	Ø4.3	0.5	Small	AROCSS3805RT
		1		AROCSS3810RT
		2		AROCSS3820RT
Ø5.5	0.5	Large	AROCSS4505RT	
	1		AROCSS4510RT	
	2		AROCSS4520RT	
AnyOne	Ø3.9	0.5	Small	AOICSS3405T
		1		AOICSS3410T
		2		AOICSS3420T
	Ø4.3	0.5	Small	AOICSS3805T
		1		AOICSS3810T
		2		AOICSS3820T
	Ø5.5	0.5	Large	AOICSL4505T
		1		AOICSL4510T
		2		AOICSL4520T

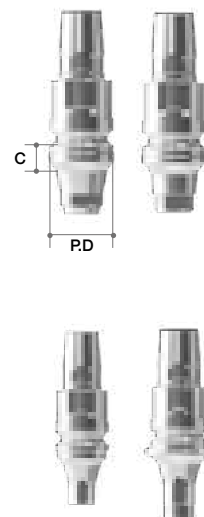

Scan Healing Abutment & Scan Post

- Abutment Screw included.
- AnyRidge (ARIHS1804/ARIHS1805/ARIHS1807)
- AnyOne (AOIHS2004/AOIHS2005/AOIHS2007)
- AnyRidge Octa 1 (AROHS1604/AROHS1605/ AROHS1607)

- Can get scan data without removing Scan Healing Abutment from Scan Post
- Different colors depend on the cuff size
- Scan healing abutment should be exposed 2.0mm on the surgical site for accurate scanning

- Scan Healing Abutment should be exposed 2.0mm from the surgical site for accurate scanning. Scanning would be much easier if you connect Scan Post when scanning seems difficult due to less exposure of Scan Healing Abutment or other conditions.
- Select Scan Post based on the diameter of Scan Healing Abutment
- Scan Post is a disposable product and sold separately in batch of 10EA. for each package

System	Profile Diameter	Scan Post	Height (mm)	Ref.C
AnyRidge	Ø4.0	SP4007.MTN	4	ARISH4004T
			5	ARISH4005T
			7	ARISH4007T
	Ø5.0	SP5007.MTN	4	ARISH5004T
			5	ARISH5005T
			7	ARISH5007T
	Ø6.0	SP6007.MTN	4	ARISH6004T
			5	ARISH6005T
			7	ARISH6007T
	Ø7.0	SP7007.MTN	4	ARISH7004T
			5	ARISH7005T
			7	ARISH7007T
Ø5.0 (Extra type)	SP5007.MTN	4	ARNSH5004T	
		5	ARNSH5005T	
		7	ARNSH5007T	
Ø6.0 (Extra type)	SP6007.MTN	4	ARNSH6004T	
		5	ARNSH6005T	
		7	ARNSH6007T	
AnyRidge Octa 1	Ø4.0	SP4007.MTN	4	AROISHN4004T
			5	AROISHN4005T
			7	AROISHN4007T
	Ø5.0	SP5007.MTN	4	AROISHN5004T
			5	AROISHN5005T
			7	AROISHN5007T
	Ø4.0	SP4007.MTN	4	AROISHR4004T
			5	AROISHR4005T
			7	AROISHR4007T
	Ø5.0	SP5007.MTN	4	AROISHR5004T
			5	AROISHR5005T
			7	AROISHR5007T
Ø6.0	SP6007.MTN	4	AROISHR6004T	
		5	AROISHR6005T	
		7	AROISHR6007T	
Ø7.0	SP7007.MTN	4	AROISHR7004T	
		5	AROISHR7005T	
		7	AROISHR7007T	
AnyOne	Ø4.0	SP4007.MTN	4	AOISH4004T
			5	AOISH4005T
			7	AOISH4007T
	Ø4.5	SP5007.MTN	4	AOISH4504T
			5	AOISH4505T
			7	AOISH4507T
	Ø5.5	SP6007.MTN	4	AOISH5504T
			5	AOISH5505T
			7	AOISH5507T
	Ø6.5	SP7007.MTN	4	AOISH6504T
			5	AOISH6505T
			7	AOISH6507T

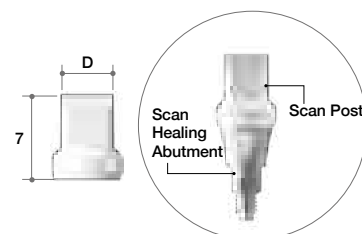

* If Scan Healing Abutment is exposed more than 2.5mm, it may destabilize a fixture and results in fixture failure.

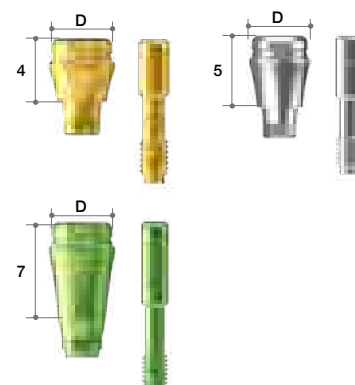

Scan Post Carrier

System	Length	Ref.C
Common	19	SPC16

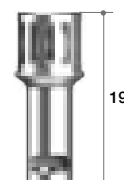

➔ RP Analog Option

RP Analog

- For Chairside/ Labside
- Included spare Abutment Screw
- Supporting Dental CAD
 - 3 Shape
 - Exocad

System	Profile Diameter	Length (mm)	Type	Ref.C
AnyRidge	Ø4.0	9	-	CANIAR4009
AnyRidge Octa 1	Ø3.3	10	NC	AROLAN
	Ø4.1		RC	AROLAR
AnyOne Internal	Ø4.0	9	Only Ø3.5	CAOIAS3509
			-	CAOJAR4009
AnyOne External	Ø3.5	9	Small	CEXEAS3509
	Ø4.1		Regular	CEXEAR4109
	Ø5.0		Wide	CEXEA5009
AnyOne OneStage	Ø4.8	9	Cuff 1.8	OSRA18
MINi	Ø3.0	9	-	CMIIAN3009
ST	Ø3.7	9	Small	OSRA3709
	Ø4.3		Regular	OSRA4309
Octa Level	Ø3.8	9	Small	OCTARA4
	Ø4.8		Regular	OCTARA5
	Ø5.8		Wide	OCTARA6
MUA Level (N-Type)	Ø4.8	9	-	MUALA

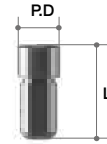

NEW!!

➔ ZrGEN Abutment Option

ZrGEN Abutment

- Abutment Screw included.
 - . AnyRidge (AANMSF)
 - . AnyOne Internal (AS20)
 - . AnyOne Exeternal(SCS160/ RCS200)
 - . AnyOne Stage (
 - . MiNi (MIAZ1410)
 - . ST(OSGSAS3110/OSGSAS3210)
 - . Octa Level(IRCS200)
 - . AnyRidge Octa 1(AROAS16B/ AROAS16)
- Titanium Base
- 1Set(=Abutment 10ea)
 - included spare Abutment Screw
 - MiNi ZrGEN has special ZrGEN Screw
- Supporting DentalCAD
 - 3 Shape
 - Exocad
 - Dental Wing
- Different groove number depend on the post size
 - P=4.5 ▶ groove number : 2ea
 - P=5 ▶ groove number : 3ea
 - P=6 ▶ groove number : 4ea
 - P=8 ▶ groove number : 6ea

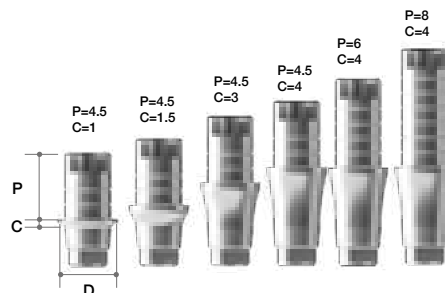

Standard

System	Diameter	Cuff Height	Post Height	Type	Ref.C
AnyRidge	Ø4.0	0.6	4.5	Hex	AANIPR4015.MTN
			6		AANIPR4016.MTN
			8		AANIPR4018.MTN
		1.5	4.5		AANIPR4025.MTN
			6		AANIPR4026.MTN
			8		AANIPR4028.MTN
		3.0	4.5		AANIPR4035.MTN
			6		AANIPR4036.MTN
			8		AANIPR4038.MTN
		4.0	4.5		AANIPR4045.MTN
			6		AANIPR4046.MTN
			8		AANIPR4048.MTN
	Ø4.5	0.6	4.5	Non-Hex	AANIPR4015N.MTN
			6		AANIPR4016N.MTN
			8		AANIPR4018N.MTN
		1.5	4.5		AANIPR4025N.MTN
			6		AANIPR4026N.MTN
			8		AANIPR4028N.MTN
		3.0	4.5		AANIPR4035N.MTN
			6		AANIPR4036N.MTN
			8		AANIPR4038N.MTN
		4.0	4.5		AANIPR4045N.MTN
			6		AANIPR4046N.MTN
			8		AANIPR4048N.MTN
Ø4.5	0.6	4.5	Hex	AANIPR4515.MTN	
		6		AANIPR4516.MTN	
		8		AANIPR4518.MTN	
	1.5	4.5		AANIPR4525.MTN	
		6		AANIPR4526.MTN	
		8		AANIPR4528.MTN	
	3.0	4.5		AANIPR4535.MTN	
		6		AANIPR4536.MTN	
		8		AANIPR4538.MTN	
	4.0	4.5		AANIPR4545.MTN	
		6		AANIPR4546.MTN	
		8		AANIPR4548.MTN	
Ø4.5	0.6	4.5	Non-Hex	AANIPR4515N.MTN	
		6		AANIPR4516N.MTN	
		8		AANIPR4518N.MTN	
	1.5	4.5		AANIPR4525N.MTN	
		6		AANIPR4526N.MTN	
		8		AANIPR4528N.MTN	
	3.0	4.5		AANIPR4535N.MTN	
		6		AANIPR4536N.MTN	
		8		AANIPR4538N.MTN	
	4.0	4.5		AANIPR4545N.MTN	
		6		AANIPR4546N.MTN	
		8		AANIPR4548N.MTN	

System	Diameter	Cuff Height	Post Height	Type	Ref.C
AnyRidge Octa 1	Ø4.0	0.6	4.5	-	AROZGN4015.MTN
			1.5		AROZGN4025.MTN
			3.0		AROZGN4035.MTN
		1.5	4.0		AROZGN4045.MTN
			0.6		AROZGN4016.MTN
			1.5		AROZGN4026.MTN
		3.0	3.0		AROZGN4036.MTN
			4.0		AROZGN4046.MTN
			0.6		AROZGN4018.MTN
	Ø4.5	0.6	8.0	-	AROZGN4028.MTN
			1.5		AROZGN4038.MTN
			3.0		AROZGN4048.MTN
		1.5	4.5		AROZGR4515.MTN
			1.5		AROZGR4525.MTN
			3.0		AROZGR4535.MTN
		3.0	4.0		AROZGR4545.MTN
			0.6		AROZGR4516.MTN
			1.5		AROZGR4526.MTN
4.0	3.0	AROZGR4536.MTN			
	4.0	AROZGR4546.MTN			
	0.6	AROZGR4518.MTN			
MUA Level	Ø5.5	0.8	5	N-Type (Nobel)	AMUAPR5515N.MTN
			6		AMUAPR5516N.MTN
			8		AMUAPR5518N.MTN
	1.7	5	AMUAPR5525N.MTN		
		6	AMUAPR5526N.MTN		
		8	AMUAPR5528N.MTN		
	3.0	5	AMUAPR5535N.MTN		
		6	AMUAPR5536N.MTN		
		8	AMUAPR5538N.MTN		
4.0	5	AMUAPR5545N.MTN			
	6	AMUAPR5546N.MTN			
	8	AMUAPR5548N.MTN			

Standard

System	Diameter	Cuff Height	Post Height	Type	Ref.C
AnyOne Internal	Ø4.0	0.6	4.5	Hex	AAOIPR4015.MTN
			6		AAOIPR4016.MTN
			8		AAOIPR4018.MTN
		1.5	4.5		AAOIPR4025.MTN
			6		AAOIPR4026.MTN
			8		AAOIPR4028.MTN
		3.0	4.5		AAOIPR4035.MTN
			6		AAOIPR4036.MTN
			8		AAOIPR4038.MTN
		4.0	4.5		AAOIPR4045.MTN
			6		AAOIPR4046.MTN
			8		AAOIPR4048.MTN
	Ø4.5	0.6	4.5	Non-Hex	AAOIPR4015N.MTN
			6		AAOIPR4016N.MTN
			8		AAOIPR4018N.MTN
		1.5	4.5		AAOIPR4025N.MTN
			6		AAOIPR4026N.MTN
			8		AAOIPR4028N.MTN
		3.0	4.5		AAOIPR4035N.MTN
			6		AAOIPR4036N.MTN
			8		AAOIPR4038N.MTN
		4.0	4.5		AAOIPR4045N.MTN
			6		AAOIPR4046N.MTN
			8		AAOIPR4048N.MTN
	Ø4.5	0.6	4.5	Hex	AAOIPR4515.MTN
			6		AAOIPR4516.MTN
			8		AAOIPR4518.MTN
		1.5	4.5		AAOIPR4525.MTN
			6		AAOIPR4526.MTN
			8		AAOIPR4528.MTN
		3.0	4.5		AAOIPR4535.MTN
			6		AAOIPR4536.MTN
			8		AAOIPR4538.MTN
		4.0	4.5		AAOIPR4545.MTN
			6		AAOIPR4546.MTN
			8		AAOIPR4548.MTN
	Ø4.5	0.6	4.5	Non-Hex	AAOIPR4515N.MTN
			6		AAOIPR4516N.MTN
			8		AAOIPR4518N.MTN
		1.5	4.5		AAOIPR4525N.MTN
			6		AAOIPR4526N.MTN
			8		AAOIPR4528N.MTN
		3.0	4.5		AAOIPR4535N.MTN
			6		AAOIPR4536N.MTN
			8		AAOIPR4538N.MTN
		4.0	4.5		AAOIPR4545N.MTN
			6		AAOIPR4546N.MTN
			8		AAOIPR4548N.MTN

System	Diameter	Cuff Height	Post Height	Type	Ref.C
AnyOne External	Small	Ø4.2	0.6	4.5	AEXEPS4015.MTN
				6	AEXEPS4016.MTN
				8	AEXEPS4018.MTN
		1.5	4.5	AEXEPS4025.MTN	
			6	AEXEPS4026.MTN	
			8	AEXEPS4028.MTN	
		3.0	4.5	AEXEPS4035.MTN	
			6	AEXEPS4036.MTN	
			8	AEXEPS4038.MTN	
		4.0	4.5	AEXEPS4045.MTN	
			6	AEXEPS4046.MTN	
			8	AEXEPS4048.MTN	
	Ø4.5	0.6	4.5	Hex	AEXEPS4515.MTN
			6		AEXEPS4516.MTN
			8		AEXEPS4518.MTN
		1.5	4.5		AEXEPS4525.MTN
			6		AEXEPS4526.MTN
			8		AEXEPS4528.MTN
		3.0	4.5		AEXEPS4535.MTN
			6		AEXEPS4536.MTN
			8		AEXEPS4538.MTN
		4.0	4.5		AEXEPS4545.MTN
			6		AEXEPS4546.MTN
			8		AEXEPS4548.MTN
	Regular	Ø4.5	0.6	4.5	AEXEPR4515.MTN
				6	AEXEPR4516.MTN
				8	AEXEPR4518.MTN
		1.5	4.5	AEXEPR4525.MTN	
			6	AEXEPR4526.MTN	
			8	AEXEPR4528.MTN	
		3.0	4.5	AEXEPR4535.MTN	
			6	AEXEPR4536.MTN	
			8	AEXEPR4538.MTN	
		4.0	4.5	AEXEPR4545.MTN	
			6	AEXEPR4546.MTN	
			8	AEXEPR4548.MTN	
	Wide	Ø5.5	0.6	4.5	AEXEPW5515.MTN
				6	AEXEPW5516.MTN
				8	AEXEPW5518.MTN
		1.5	4.5	AEXEPW5525.MTN	
			6	AEXEPW5526.MTN	
			8	AEXEPW5528.MTN	
		3.0	4.5	AEXEPW5535.MTN	
			6	AEXEPW5536.MTN	
			8	AEXEPW5538.MTN	
		4.0	4.5	AEXEPW5545.MTN	
			6	AEXEPW5546.MTN	
			8	AEXEPW5548.MTN	
AnyOne OneStage	Cuff 1.8	Ø4.8	Octa	4.5	AEXIPR5015.MTN
				6	AEXIPR5016.MTN
				8	AEXIPR5018.MTN
	1.5	4.5		AEXIPR5025.MTN	
		6		AEXIPR5026.MTN	
		8		AEXIPR5028.MTN	
	3.0	4.5		AEXIPR5035.MTN	
		6		AEXIPR5036.MTN	
		8		AEXIPR5038.MTN	
	4.0	4.5		AEXIPR5045.MTN	
		6		AEXIPR5046.MTN	
		8		AEXIPR5048.MTN	

Standard

System	Diameter	Cuff Height	Post Height	Type	Ref.C	System	Diameter	Cuff Height	Post Height	Type	Ref.C
MINi	Ø3.0	0.6	2.5	Hex	MIPN3013.MTN			0.8	5	Octa	AOCEPS5015.MTN
			2.5	Non-Hex	MIPN3013N.MTN				6		AOCEPS5016.MTN
Small	Ø4.0	0.6	4.5	Hex	OSGSPA3111.MTN	Small	Ø5.0	1.7	8	Octa	AOCEPS5018.MTN
			6		5				AOCEPS5025.MTN		
			8		6				AOCEPS5026.MTN		
		1.5	4.5		8			AOCEPS5028.MTN			
			6		5			AOCEPS5035.MTN			
			8		6			AOCEPS5036.MTN			
		3.0	4.5		8			AOCEPS5038.MTN			
			6		5			AOCEPS5045.MTN			
			8		6			AOCEPS5046.MTN			
		4.0	4.5		8			AOCEPS5048.MTN			
6	5		ANOEPS5015.MTN								
8	6		ANOEPS5016.MTN								
ST	Ø4.0	0.6	4.5	Hex	OSGSPA3111N.MTN	ST	Ø4.0	1.7	8	Non-Octa	ANOEPS5018.MTN
			6		5				ANOEPS5025.MTN		
			8		6				ANOEPS5026.MTN		
		1.5	4.5		8			ANOEPS5028.MTN			
			6		5			ANOEPS5035.MTN			
			8		6			ANOEPS5036.MTN			
		3.0	4.5		8			ANOEPS5038.MTN			
			6		5			ANOEPS5045.MTN			
			8		6			ANOEPS5046.MTN			
		4.0	4.5		8			ANOEPS5048.MTN			
6	5		AOCEPR5515.MTN								
8	6		AOCEPR5516.MTN								
Regular	Ø4.5	0.6	4.5	Hex	OSGSPA3211.MTN	Regular	Ø5.5	1.7	8	Octa	AOCEPR5518.MTN
			6		5				AOCEPR5525.MTN		
			8		6				AOCEPR5526.MTN		
		1.5	4.5		8			AOCEPR5528.MTN			
			6		5			AOCEPR5535.MTN			
			8		6			AOCEPR5536.MTN			
		3.0	4.5		8			AOCEPR5538.MTN			
			6		5			AOCEPR5545.MTN			
			8		6			AOCEPR5546.MTN			
		4.0	4.5		8			AOCEPR5548.MTN			
6	5		ANOEPR5515.MTN								
8	6		ANOEPR5516.MTN								
Wide	Ø6.5	0.6	4.5	Hex	OSGSPA3211N.MTN	Wide	Ø6.5	1.7	8	Non-Octa	ANOEPR5518.MTN
			6		5				ANOEPR5525.MTN		
			8		6				ANOEPR5526.MTN		
		1.5	4.5		8			ANOEPR5528.MTN			
			6		5			ANOEPR5535.MTN			
			8		6			ANOEPR5536.MTN			
		3.0	4.5		8			ANOEPR5538.MTN			
			6		5			ANOEPR5545.MTN			
			8		6			ANOEPR5546.MTN			
		4.0	4.5		8			ANOEPR5548.MTN			
6	5		AOCEPW6515.MTN								
8	6		AOCEPW6516.MTN								
Regular	Ø4.5	0.6	4.5	Hex	OSGSPA4018.MTN	Regular	Ø5.5	1.7	8	Octa	AOCEPW6518.MTN
			6		5				AOCEPW6525.MTN		
			8		6				AOCEPW6526.MTN		
		1.5	4.5		8			AOCEPW6528.MTN			
			6		5			AOCEPW6535.MTN			
			8		6			AOCEPW6536.MTN			
		3.0	4.5		8			AOCEPW6538.MTN			
			6		5			AOCEPW6545.MTN			
			8		6			AOCEPW6546.MTN			
		4.0	4.5		8			AOCEPW6548.MTN			
6	5		ANOEPW6515.MTN								
8	6		ANOEPW6516.MTN								
Regular	Ø4.5	0.6	4.5	Hex	OSGSPA4022.MTN	Regular	Ø6.5	1.7	8	Non-Octa	ANOEPW6518.MTN
			6		5				ANOEPW6525.MTN		
			8		6				ANOEPW6526.MTN		
		1.5	4.5		8			ANOEPW6528.MTN			
			6		5			ANOEPW6535.MTN			
			8		6			ANOEPW6536.MTN			
		3.0	4.5		8			ANOEPW6538.MTN			
			6		5			ANOEPW6545.MTN			
			8		6			ANOEPW6546.MTN			
		4.0	4.5		8			ANOEPW6548.MTN			
6	5		OSGSPA4515.MTN								
8	6		OSGSPA4516.MTN								
Regular	Ø4.5	0.6	4.5	Hex	OSGSPA4025N.MTN	Regular	Ø6.5	1.7	8	Non-Octa	ANOEPW6525.MTN
			6		5				ANOEPW6526.MTN		
			8		6				ANOEPW6528.MTN		
		1.5	4.5		8			ANOEPW6535.MTN			
			6		5			ANOEPW6536.MTN			
			8		6			ANOEPW6538.MTN			
		3.0	4.5		8			ANOEPW6545.MTN			
			6		5			ANOEPW6546.MTN			
			8		6			ANOEPW6548.MTN			
		4.0	4.5		8			OSGSPA4515N.MTN			
6	5		OSGSPA4516N.MTN								
8	6		OSGSPA4518N.MTN								
Regular	Ø4.5	0.6	4.5	Hex	OSGSPA4028N.MTN	Regular	Ø6.5	1.7	8	Non-Octa	ANOEPW6525.MTN
			6		5				ANOEPW6526.MTN		
			8		6				ANOEPW6528.MTN		
		1.5	4.5		8			ANOEPW6535.MTN			
			6		5			ANOEPW6536.MTN			
			8		6			ANOEPW6538.MTN			
		3.0	4.5		8			ANOEPW6545.MTN			
			6		5			ANOEPW6546.MTN			
			8		6			ANOEPW6548.MTN			
		4.0	4.5		8			OSGSPA4035N.MTN			
6	5		OSGSPA4036N.MTN								
8	6		OSGSPA4038N.MTN								
Regular	Ø4.5	0.6	4.5	Hex	OSGSPA40408.MTN	Regular	Ø6.5	1.7	8	Non-Octa	ANOEPW6525.MTN
			6		5				ANOEPW6526.MTN		
			8		6				ANOEPW6528.MTN		
		1.5	4.5		8			ANOEPW6535.MTN			
			6		5			ANOEPW6536.MTN			
			8		6			ANOEPW6538.MTN			
		3.0	4.5		8			ANOEPW6545.MTN			
			6		5			ANOEPW6546.MTN			
			8		6			ANOEPW6548.MTN			
		4.0	4.5		8			OSGSPA4045N.MTN			
6	5		OSGSPA4046N.MTN								
8	6		OSGSPA4048N.MTN								
Regular	Ø4.5	0.6	4.5	Hex	OSGSPA4515.MTN	Regular	Ø6.5	1.7	8	Non-Octa	ANOEPW6525.MTN
			6		5				ANOEPW6526.MTN		
			8		6				ANOEPW6528.MTN		
		1.5	4.5		8			ANOEPW6535.MTN			
			6		5			ANOEPW6536.MTN			
			8		6			ANOEPW6538.MTN			
		3.0	4.5		8			ANOEPW6545.MTN			
			6		5			ANOEPW6546.MTN			
			8		6			ANOEPW6548.MTN			
		4.0	4.5		8			OSGSPA4515N.MTN			
6	5		OSGSPA4516N.MTN								
8	6		OSGSPA4518N.MTN								
Regular	Ø4.5	0.6	4.5	Hex	OSGSPA4528.MTN	Regular	Ø6.5	1.7	8	Non-Octa	ANOEPW6525.MTN
			6		5				ANOEPW6526.MTN		
			8		6				ANOEPW6528.MTN		
		1.5	4.5		8			ANOEPW6535.MTN			
			6		5			ANOEPW6536.MTN			
			8		6			ANOEPW6538.MTN			
		3.0	4.5		8			ANOEPW6545.MTN			
			6		5			ANOEPW6546.MTN			
			8		6			ANOEPW6548.MTN			
		4.0	4.5		8			OSGSPA4535N.MTN			
6	5		OSGSPA4536N.MTN								
8	6		OSGSPA4538N.MTN								
Regular	Ø4.5	0.6	4.5	Hex	OSGSPA4545.MTN	Regular	Ø6.5	1.7	8	Non-Octa	ANOEPW6525.MTN
			6		5				ANOEPW6526.MTN		
			8		6				ANOEPW6528.MTN		
		1.5	4.5		8			ANOEPW6535.MTN			
			6		5			ANOEPW6536.MTN			
			8		6			ANOEPW6538.MTN			
		3.0	4.5		8			ANOEPW6545.MTN			
			6		5			ANOEPW6546.MTN			
			8		6			ANOEPW6548.MTN			
		4.0	4.5		8			OSGSPA4545N.MTN			
6	5		OSGSPA4546N.MTN								
8	6		OSGSPA4548N.MTN								

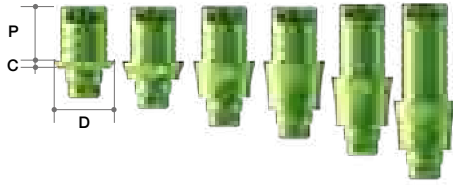

Extra

System	Fixture Core	Diameter	Cuff Height	Post Height	Type	Ref.C	
AnyRidge	Core 3.3	Ø4.5	0.6	4.5	Hex	ARZXM4515.MTN	
				6		ARZXM4516.MTN	
				8		ARZXM4518.MTN	
			1.5	4.5		ARZXM4525.MTN	
				6		ARZXM4526.MTN	
				8		ARZXM4528.MTN	
			3.0	4.5		ARZXM4535.MTN	
				6		ARZXM4536.MTN	
				8		ARZXM4538.MTN	
			4.0	4.5		ARZXM4545.MTN	
				6		ARZXM4546.MTN	
				8		ARZXM4548.MTN	
			Non -Hex	0.6		4.5	ARZXM4515N.MTN
						6	ARZXM4516N.MTN
						8	ARZXM4518N.MTN
				1.5		4.5	ARZXM4525N.MTN
						6	ARZXM4526N.MTN
						8	ARZXM4528N.MTN
				3.0		4.5	ARZXM4535N.MTN
						6	ARZXM4536N.MTN
						8	ARZXM4538N.MTN
				4.0		4.5	ARZXM4545N.MTN
						6	ARZXM4546N.MTN
						8	ARZXM4548N.MTN
	Core3.8	Ø5.0	0.6	4.5	Hex	ARZXM503815.MTN	
				6		ARZXM503816.MTN	
				8		ARZXM503818.MTN	
			1.5	4.5		ARZXM503825.MTN	
				6		ARZXM503826.MTN	
				8		ARZXM503828.MTN	
			3.0	4.5		ARZXM503835.MTN	
				6		ARZXM503836.MTN	
				8		ARZXM503838.MTN	
			4.0	4.5		ARZXM503845.MTN	
				6		ARZXM503846.MTN	
				8		ARZXM503848.MTN	
		Non -Hex	0.6	4.5		ARZXM503815N.MTN	
				6		ARZXM503816N.MTN	
				8		ARZXM503818N.MTN	
			1.5	4.5		ARZXM503825N.MTN	
				6		ARZXM503826N.MTN	
				8		ARZXM503828N.MTN	
			3.0	4.5		ARZXM503835N.MTN	
				6		ARZXM503836N.MTN	
				8		ARZXM503838N.MTN	
			4.0	4.5		ARZXM503845N.MTN	
				6		ARZXM503846N.MTN	
				8		ARZXM503848N.MTN	
Ø5.5	Hex	0.6	4.5	ARZXM553815.MTN			
			6	ARZXM553816.MTN			
			8	ARZXM553818.MTN			
		1.5	4.5	ARZXM553825.MTN			
			6	ARZXM553826.MTN			
			8	ARZXM553828.MTN			
		3.0	4.5	ARZXM553835.MTN			
			6	ARZXM553836.MTN			
			8	ARZXM553838.MTN			
		4.0	4.5	ARZXM553845.MTN			
			6	ARZXM553846.MTN			
			8	ARZXM553848.MTN			
	Non -Hex	0.6	4.5	ARZXM553815N.MTN			
			6	ARZXM553816N.MTN			
			8	ARZXM553818N.MTN			
		1.5	4.5	ARZXM553825N.MTN			
			6	ARZXM553826N.MTN			
			8	ARZXM553828N.MTN			
		3.0	4.5	ARZXM553835N.MTN			
			6	ARZXM553836N.MTN			
			8	ARZXM553838N.MTN			
		4.0	4.5	ARZXM553845N.MTN			
			6	ARZXM553846N.MTN			
			8	ARZXM553848N.MTN			

Extra

System	Fixture Core	Diameter	Cuff Height	Post Height	Type	Ref.C	
AnyRidge	Core4.0	Ø5.0	0.6	4.5	Hex	ARZXM5015.MTN	
				6		ARZXM5016.MTN	
				8		ARZXM5018.MTN	
			1.5	4.5		ARZXM5025.MTN	
				6		ARZXM5026.MTN	
				8		ARZXM5028.MTN	
			3.0	4.5		ARZXM5035.MTN	
				6		ARZXM5036.MTN	
				8		ARZXM5038.MTN	
			4.0	4.5		ARZXM5045.MTN	
				6		ARZXM5046.MTN	
				8		ARZXM5048.MTN	
		Ø5.5	0.6	4.5	Non -Hex	ARZXM5015N.MTN	
				6		ARZXM5016N.MTN	
				8		ARZXM5018N.MTN	
			1.5	4.5		ARZXM5025N.MTN	
				6		ARZXM5026N.MTN	
				8		ARZXM5028N.MTN	
			3.0	4.5		ARZXM5035N.MTN	
				6		ARZXM5036N.MTN	
				8		ARZXM5038N.MTN	
			4.0	4.5		ARZXM5045N.MTN	
				6		ARZXM5046N.MTN	
				8		ARZXM5048N.MTN	
		Ø5.5	0.6	4.5	Hex	ARZXM5515.MTN	
						6	ARZXM5516.MTN
						8	ARZXM5518.MTN
				1.5		4.5	ARZXM5525.MTN
						6	ARZXM5526.MTN
						8	ARZXM5528.MTN
				3.0		4.5	ARZXM5535.MTN
						6	ARZXM5536.MTN
						8	ARZXM5538.MTN
				4.0		4.5	ARZXM5545.MTN
						6	ARZXM5546.MTN
						8	ARZXM5548.MTN
			0.6	4.5	Non -Hex	ARZXM5515N.MTN	
						6	ARZXM5516N.MTN
						8	ARZXM5518N.MTN
				1.5		4.5	ARZXM5525N.MTN
						6	ARZXM5526N.MTN
						8	ARZXM5528N.MTN
				3.0		4.5	ARZXM5535N.MTN
						6	ARZXM5536N.MTN
						8	ARZXM5538N.MTN
				4.0		4.5	ARZXM5545N.MTN
						6	ARZXM5546N.MTN
						8	ARZXM5548N.MTN

System	Fixture Core	Diameter	Cuff Height	Post Height	Type	Ref.C	
AnyRidge	Core 4.8	Ø5.5	0.6	4.5	Hex	ARZXL5515.MTN	
				6		ARZXL5516.MTN	
				8		ARZXL5518.MTN	
			1.5	4.5		ARZXL5525.MTN	
				6		ARZXL5526.MTN	
				8		ARZXL5528.MTN	
			3.0	4.5		ARZXL5535.MTN	
				6		ARZXL5536.MTN	
				8		ARZXL5538.MTN	
			4.0	4.5		ARZXL5545.MTN	
				6		ARZXL5546.MTN	
				8		ARZXL5548.MTN	
		Ø6.0	0.6	4.5	Hex	ARZXL6015.MTN	
						6	ARZXL6016.MTN
						8	ARZXL6018.MTN
				1.5		4.5	ARZXL6025.MTN
						6	ARZXL6026.MTN
						8	ARZXL6028.MTN
				3.0		4.5	ARZXL6035.MTN
						6	ARZXL6036.MTN
						8	ARZXL6038.MTN
				4.0		4.5	ARZXL6045.MTN
						6	ARZXL6046.MTN
						8	ARZXL6048.MTN
			0.6	4.5	Non -Hex	ARZXL6015N.MTN	
						6	ARZXL6016N.MTN
						8	ARZXL6018N.MTN
				1.5		4.5	ARZXL6025N.MTN
						6	ARZXL6026N.MTN
						8	ARZXL6028N.MTN
				3.0		4.5	ARZXL6035N.MTN
						6	ARZXL6036N.MTN
						8	ARZXL6038N.MTN
				4.0		4.5	ARZXL6045N.MTN
						6	ARZXL6046N.MTN
						8	ARZXL6048N.MTN

- ZrGEN Abutment

- Ti-base for Sirona Cerec users → CEREC
- In in Lab CAD Software, compatible with Xive Library

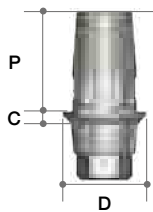
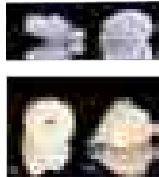

C-Type

System	Diameter	Cuff Height	Post Height	Post Size	Ref.C		
AnyRidge	Ø3.9	0.5	4.7	Small	ARCS3405.MTN		
		1			ARCS3410.MTN		
		2			ARCS3420.MTN		
	Ø4.3	0.5			ARCS3805.MTN		
		1			ARCS3810.MTN		
		2			ARCS3820.MTN		
	Ø5.5	0.5		Large	ARCL4505.MTN		
		1			ARCL4510.MTN		
		2			ARCL4520.MTN		
AnyRidge Octa 1	Ø3.9	0.5	4.5	Small	AROCNS3405.MTN		
		1.0			AROCNS3410.MTN		
		2.0			AROCNS3420.MTN		
		Ø4.3			0.5	AROCNS3805.MTN	
					1.0	AROCNS3810.MTN	
					2.0	AROCNS3820.MTN	
	Ø3.9	0.5		Small	AROCSR3405.MTN		
		1.0			AROCSR3410.MTN		
		2.0			AROCSR3420.MTN		
		Ø4.3			0.5	AROCSR3805.MTN	
					1.0	AROCSR3810.MTN	
					2.0	AROCSR3820.MTN	
	Ø5.5	0.5		Large	AROCLR4505.MTN		
		1.0			AROCLR4510.MTN		
		2.0			AROCLR4520.MTN		
	AnyOne	Ø3.9		0.5	4.7	Small	AOCS3405.MTN
				1			AOCS3410.MTN
				2			AOCS3420.MTN
Ø4.3		0.5	AOCS3805.MTN				
		1	AOCS3810.MTN				
		2	AOCS3820.MTN				
Ø5.5		0.5	Large	AOCL4505.MTN			
		1		AOCL4510.MTN			
		2		AOCL4520.MTN			
ST	Ø3.9	0.5	4.7	Small	STCSS3405.MTN		
		1			STCSS3410.MTN		
		2			STCSS3420.MTN		
		Ø4.3			0.5	STCSS3805.MTN	
					1	STCSS3810.MTN	
					2	STCSS3820.MTN	
	Ø3.9	0.5		Small	STCSR3405.MTN		
		1			STCSR3410.MTN		
		2			STCSR3420.MTN		
		Ø4.3			0.5	STCSR3805.MTN	
					1	STCSR3810.MTN	
					2	STCSR3820.MTN	
	Ø5.5	0.5		Large	STCLR4505.MTN		
		1			STCLR4510.MTN		
		2			STCLR4520.MTN		

Scan Abutmet (C-type)

- Abutment Screw included.
 - . AnyRidge (AANMSF)
 - . AnyOne (AS20)
 - . AnyRidge Octa 1 (AROAS16B/ AROAS16)

- Scan Post for Sirona Cerec users → CEREC
- In in Lab CAD Software, compatible with
- Xive Library

System	Profile Diameter	Cuff Height	Post Size	Ref.C	
AnyRidge	Ø3.9	0.5	Small	ARICSS3405T	
		1		ARICSS3410T	
		2		ARICSS3420T	
	Ø4.3	0.5		ARICSS3805T	
		1		ARICSS3810T	
		2		ARICSS3820T	
	Ø5.5	0.5	Large	ARICSL4505T	
		1		ARICSL4510T	
		2		ARICSL4520T	
AnyRidge Octa 1	Ø3.9	0.5	Small	AROCSS3405NT	
		1		AROCSS3410NT	
		2		AROCSS3420NT	
		Ø4.3		0.5	AROCSS3805NT
				1	AROCSS3810NT
				2	AROCSS3820NT
	RC	Ø3.9	0.5	Small	AROCSS3405RT
			1		AROCSS3410RT
			2		AROCSS3420RT
		Ø4.3	0.5		AROCSS3805RT
			1		AROCSS3810RT
			2		AROCSS3820RT
		Ø5.5	0.5	Large	AROCSL4505RT
			1		AROCSL4510RT
			2		AROCSL4520RT
AnyOne	Ø3.9	0.5	Small	AOICSS3405T	
		1		AOICSS3410T	
		2		AOICSS3420T	
	Ø4.3	0.5		AOICSS3805T	
		1		AOICSS3810T	
		2		AOICSS3820T	
	Ø5.5	0.5	Large	AOICSL4505T	
		1		AOICSL4510T	
		2		AOICSL4520T	

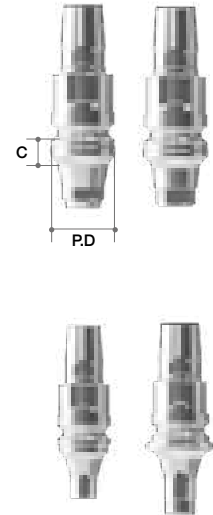

➡ TiGEN Prosthesis

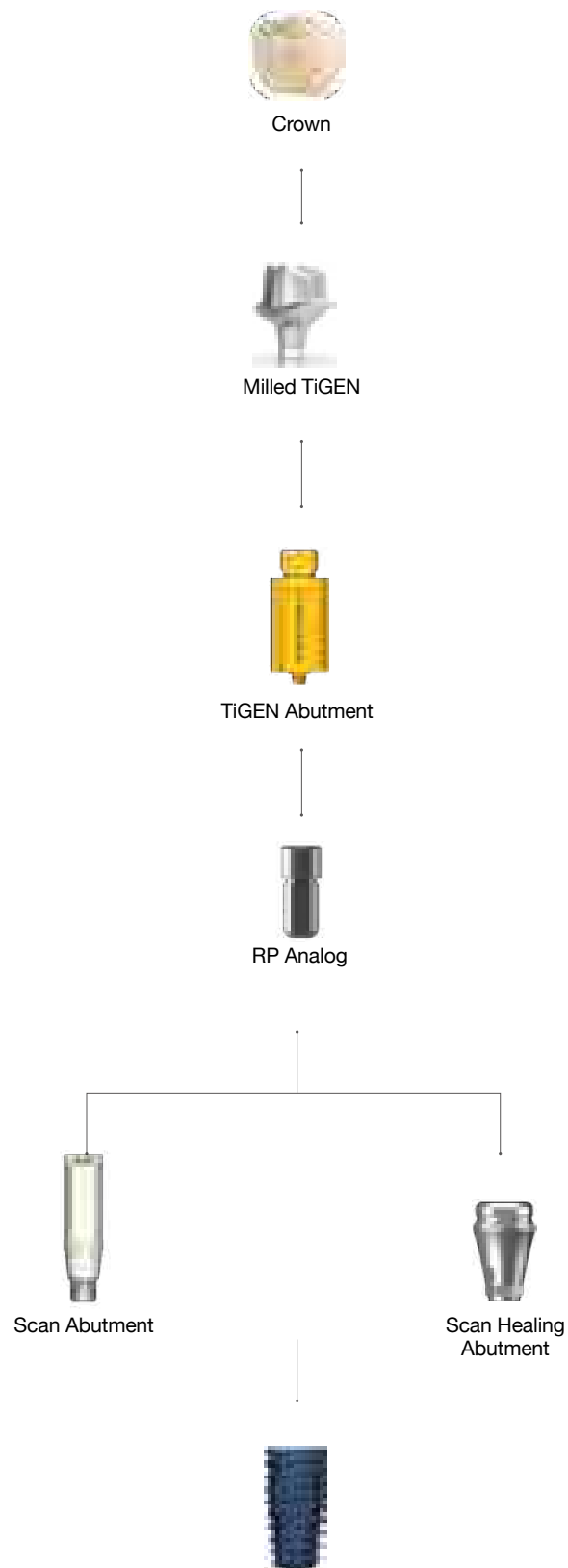

➔ TiGEN Abutment Option

TiGEN Abutment

- Abutment Screw included.
- . AnyRidge (AANMSF)
- . AnyOne Internal (AS20)
- . AnyOne Exeternal(SCS160/ RCS200)
- . AnyOne Stage (
- . MiNi (MAZ1410)
- . ST(OSGSAS3110/OSGSAS3210)
- . Octa Level(IRCS200)
- . AnyRidge Octa 1(AROAS16B/ AROAS16)

- Pre-milled Abutment
- 1Set(=Abutment 10ea)
- included spare Abutment Screw
- Supporting DentalCAD
- 3Shape
- Exocad
- Dental Wings

Standard

System	Color	Diameter	Length	Type	Ref.C
AnyRidge	Gold	Ø10	20	Hex	ARTR1020.MTN
				Non-Hex	ARTR1020N.MTN
		Ø12		Hex	ARTR1220.MTN
				Non-Hex	ARTR1220N.MTN
AnyRidge Octa 1	NC Gold	Ø10		AROTGN1020.MTN	
		Ø12		AROTGN1220.MTN	
	RC Silver	Ø10		AROTGR1020.MTN	
		Ø12		AROTGR1220.MTN	
AnyOne Internal	Pink	Ø10	Hex	AOTR1020.MTN	
			Non-Hex	AOTR1020N.MTN	
		Ø12	Hex	AOTR1220.MTN	
			Non-Hex	AOTR1220N.MTN	
AnyOne External	N/A	Ø12	Hex	AETS1220.MTN	
			Hex	AETR1220.MTN	
			Hex	AETW1220.MTN	
MiNi	N/A	Ø10	Hex	MITN1020.MTN	
			Non-Hex	MITN1020N.MTN	
ST	Small	Sky	Ø10	OSTG3112.MTN	
			Non-Hex	OSTG3112N.MTN	
		Ø12	Hex	OSTG3111.MTN	
			Non-Hex	OSTG3111N.MTN	
	Regular	Sky	Ø10	OSTG3212.MTN	
			Non-Hex	OSTG3212N.MTN	
		Ø12	Hex	OSTG3211.MTN	
			Non-Hex	OSTG3211N.MTN	
Octa Level	Small	N/A	Octa	OCTS1020.MTN	
			Non-Octa	NOTS1020.MTN	
			Octa	OCTS1220.MTN	
			Non-Octa	NOTS1220.MTN	
			Regular	Octa	OCTR1020.MTN
				Non-Octa	NOTR1020.MTN
	Wide	Octa	OCTR1220.MTN		
		Non-Octa	NOTR1220.MTN		
		Octa	OCTW1020.MTN		
		Non-Octa	NOTW1020.MTN		
		Octa	OCTW1220.MTN		
		Non-Octa	NOTW1220.MTN		



Extra EZ Connection

System	Color	Fixture Core	Diameter	Length	Type	Ref.C
AnyRidge	Gold	3.3	Ø10	20	Hex	ARTXN1020.MTN
					Non-Hex	ARTXN1020N.MTN
					Hex	ARTXN1220.MTN
					Non-Hex	ARTXN1220N.MTN
					Hex	ARTXM1020.MTN
					Non-Hex	ARTXM1020N.MTN
		4.0	Hex		ARTXM1220.MTN	
			Non-Hex		ARTXM1220N.MTN	
		4.8	Hex		ARTXL1020.MTN	
			Non-Hex		ARTXL1020N.MTN	
			Hex		ARTXL1220.MTN	
			Non-Hex		ARTXL1220N.MTN	
Hex	ARTXL1220N.MTN					
Non-Hex	ARTXL1220N.MTN					

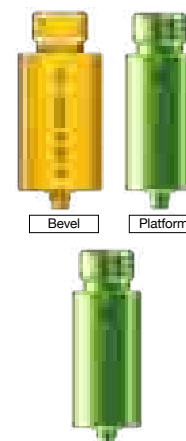

**What is the fastest
Integration time ?**

Ask AnyOne[®]

XPEED[®] surface treatment
inducing rapid osseointegration

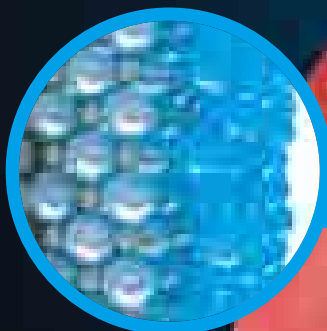

- Induction of faster and stronger Osseointegration by Ca²⁺ ion deposition on S-L-A surface
- Complete removal of acid residue by neutralization reaction during XPEED procedure.

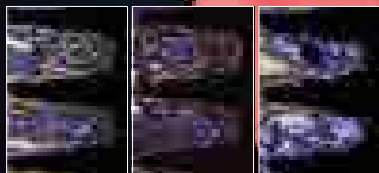

XPEED[®]

S-L-A

RBM

XPEED Surface Treatment presents much faster & stronger Osseointegration than RBM or S-L-A

High initial fixation!
KnifeThread[®]

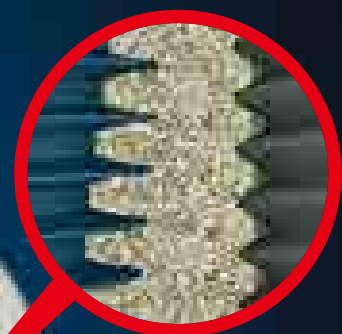

- Securement of initial stability with higher BIC
- Decentralize the stress on Cancellous bone
- Design that increases resistance and minimizes shearing force

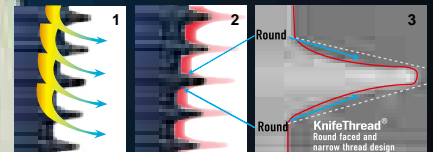

1. Stable dispersion of stress with Buttress Thread shape
2. Easier Insertion with Sharp Thread shape
3. Increase the surface area of the round side compared with the straight side.

AnyOne Internal Clinical Case

➔ Clinical Case 1

- Courtesy of Dr. Jung Sam Lee

Single molar implant with bone augmentation.

Fig 1. The second molar was missing and the alveolar bone was moderated resorbed.

Fig 2. Osteotomy socket was made with drilling.

Fig 3. An implant was placed with excellent initial stability. Even there was no bone defect around the implant, bone graft was planned to make strong periimplant tissue.

Fig 4. Autogenous bone was harvested from the ramus with Auto-Max.

Fig 5. Bone grafting with collagen membrane coverage was made.

Fig 6. Tight soft tissue adaptation with the healing abutment.

Fig 7. Soft tissue profile after 3 months.

Fig 8. Before and after treatment. (6 months from the surgery)



Fig 9. 2 years after surgery. Excellent esthetics and functions were maintained.

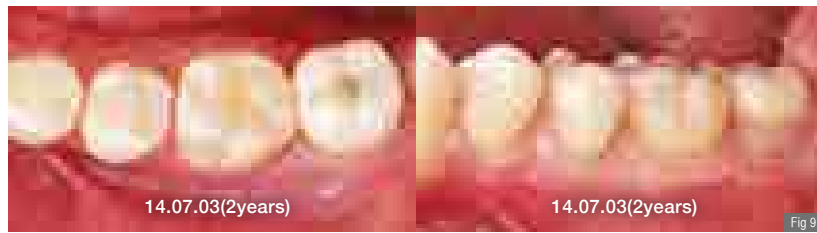

Fig 10. Intraoral radiographs on the follow-ups. Crestal bone maturation appeared interesting with time.

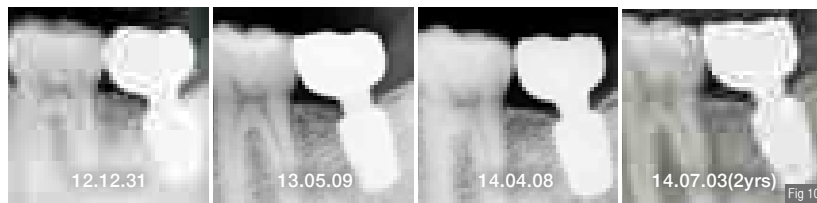

Fig 11. 5 years after surgery

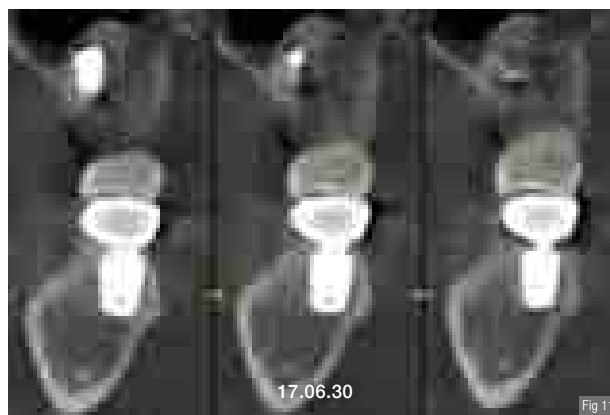
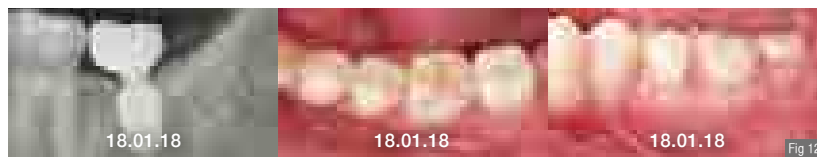

Fig 12. 5.5 years after surgery



➔ Clinical Case 2

- Courtesy of Dr. Jung Sam Lee

Two molar implants with i-Gen membrane.

Fig 1. The patient wanted to reconstruct two mandibular molars with implants.

Fig 2. There were moderate vertical and horizontal bone resorptions on the recipient sites.

Fig 3. After drilling for the osteotomy sockets, particulated autogenous bone was harvested with Auto-Max. PRP was prepared with patient's blood and mixed with autogenous and bovine bone.

Fig 4. Two implants were placed with excellent initial stability. There was no defect around implants, but bone regeneration was planned to make stable peri-implant tissues with i-Gen membrane and collagen membrane.

Fig 5. Primary closure was made following periosteal releasing incision.

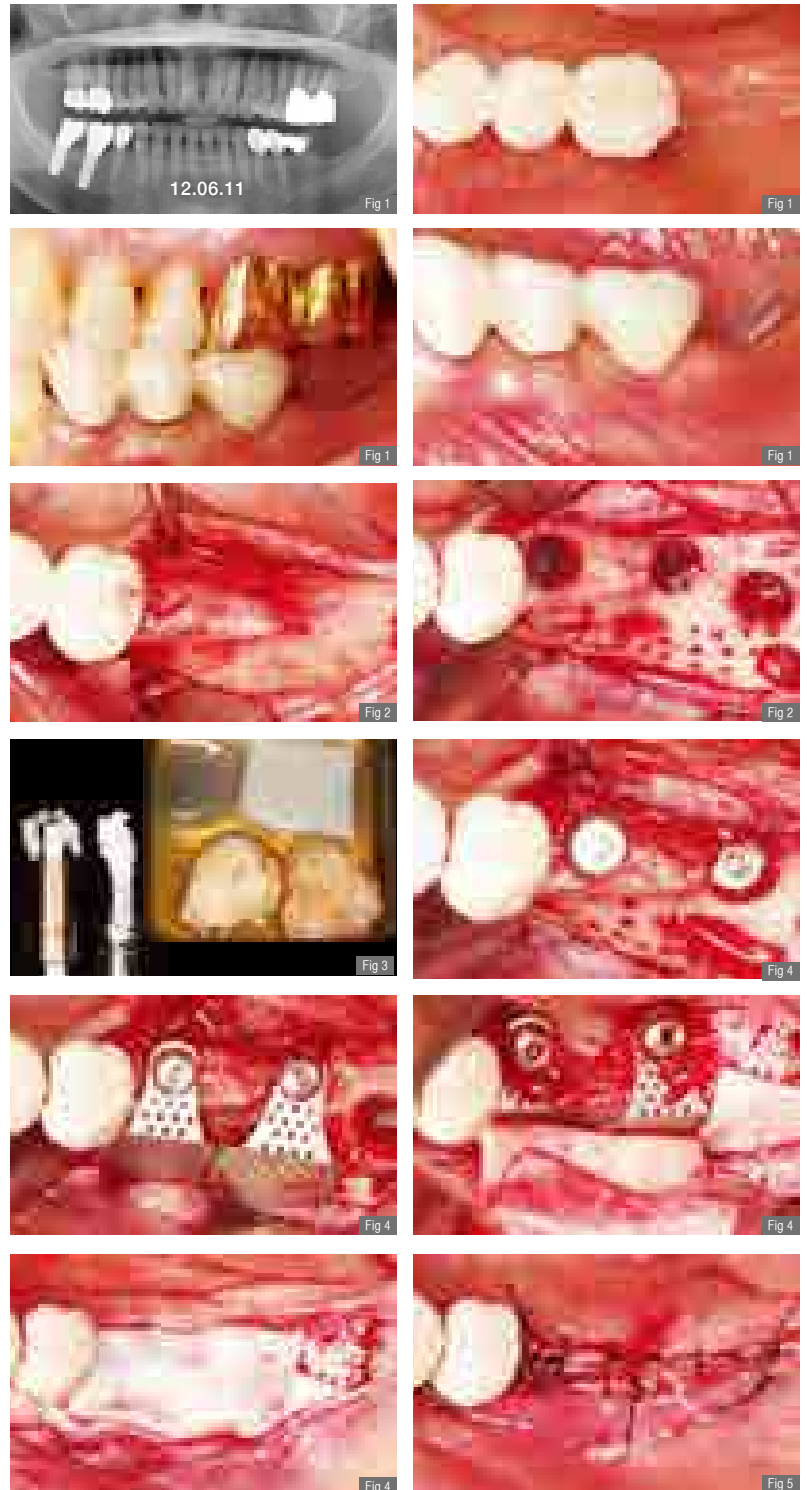

Fig 6. i-Gen membranes were removed after 2 months with simple incision. The regeneration appeared excellently with enough horizontal bone volume.

Fig 7. FGG was made to increase peri-implant keratinized gingiva.

Fig 8. Zirconia customized abutments with Ti-insert and full Zirconia crowns were made.

Fig 9. Clinical views after 1.5 years from the delivery of final restorations.

Fig 10. Intraoral radiograph after 11 months.

Fig 11. 5 years 1 month after surgery

