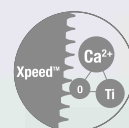
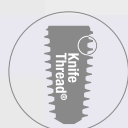


# ARI<sup>®</sup>

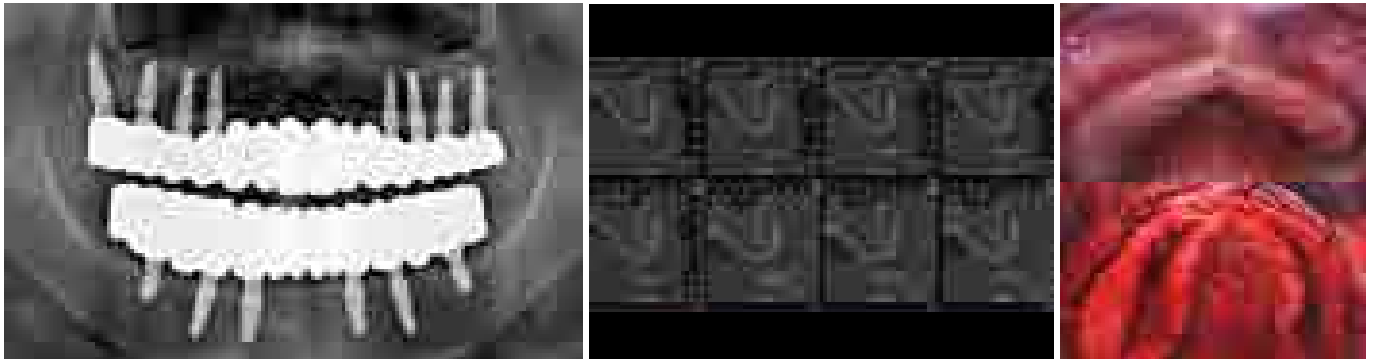
by MEGA<sup>1</sup>GEN

A New  
Game Changer in  
Anterior Atrophic Ridge



# How would you treat these cases?

**Q1** Is it possible to place implants in such an anterior atrophic thin ridge?  
In this difficult case, a long pontic area is usually created in the anterior part.



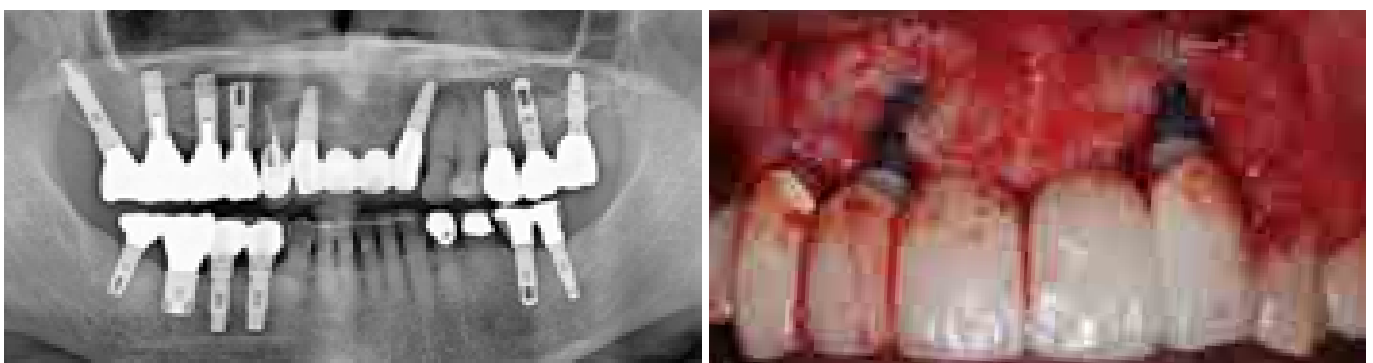
| Difficulty level                       | Treatment period                                  | Complications                      |
|--|---|------------------------------------|
| Give up or requires GBR or ridge split | Anterior teeth can only be placed after 12 months | Many complications can be expected |

**Q2** Very serious case of periodontitis, large defect with no bone, no labial plate, plus vertical bone loss. Can implants be placed?



| Difficulty level                      | Treatment Period   | Complications                      |
|---------------------------------------|--------------------|------------------------------------|
| GBR required, 2-stage implant surgery | more than 6 months | Many complications can be expected |

**Q3** Implants were placed after regeneration, but recession occurred 10 years after placement due to ridge resorption following extraction. There are so many cases like this.



Labial bone absorption begins after tooth extraction, regardless of GBR or implant placement.

Fill synthetic bone to  
create contour

**ARi<sup>®</sup>** provides a NEW SOLUTION for  
Anterior Atrophic Ridge,  
Following the achievements of AnyRidge.

- Can such patients have implants for their anterior teeth?
- Is immediate placement possible without GBR for bone volume recovery?
- Is immediate loading possible?
- Can peri-implantitis be eliminated when alveolar bone loss occurs after implant placement?

***Yes, ARi<sup>®</sup> can!***

Find the answer with **ARi<sup>®</sup>**





**Can patients have implants in their anterior teeth like this comfortably?**

No GBR!  
Single surgery  
and it's done!

Possible to deal  
with future complications  
in advance

Immediate/early  
loading is possible with  
strong initial stability

Enables long-term stability  
even if bone loss occurs

Easily overcome extreme difficulties!

**Yes, ARI<sup>®</sup> can!**



# ARi<sup>®</sup>

by MEGA'GEN



## Key Advantages

- Basal Bone implantation guarantees strong initial stability without Bone Volume restoration surgery
- Securing long-term stability without any effect even if alveolar bone loss occurs
- Special implant design that can be easily applied to Atrophic Ridges
- Minimize maintenance burden from alveolar bone recession, fracture, peri-implantitis, etc. that may occur after placement

06 Philosophy of ARi<sup>®</sup>

08 Characteristics & Advantages

13 Implant Product & Packaging

13 I. Implant Dimension

14 II. Implant Size

16 III. Packaging

17 Cover Screw & Healing Abutment

18 Abutment & Prosthetic Options

18 I. Implant Level Prosthesis

21 1. Implant Level Prosthesis\_Digital

24 II. Abutment Level Prosthesis

24 1. Solid Abutment & Components

26 2. AXA Abutment & Components

31 ARi Kit

31 I. Surgical Kit

36 II. Optional components

38 Clinical Cases

# What makes ARI<sup>®</sup> a New Game Changer for Anterior Atrophic Ridge?

ARI<sup>®</sup> is a special implant design that acquires strong stability and osseointegration from the unresorbed basal bone instead of an atrophied alveolar bone. The implant body design is also more effective for post care, and long-term stability can be secured without concern, even if the alveolar bone is lost.

## For Clinicians

- Implants can be placed in an anterior atrophic ridge, which was previously very difficult
- Fast and simple surgical protocol without bone volume recovery surgery
- Minimized maintenance burden after implantation
  - Resolving the alveolar bone recession issue: maintaining stability even when recession inevitably occurs
  - Resolving the implant fracture issue: guaranteeing maximum strength in relation to the diameter by distributing the stress concentration
  - Preventing peri-implantitis and easy treatment in case of occurrence

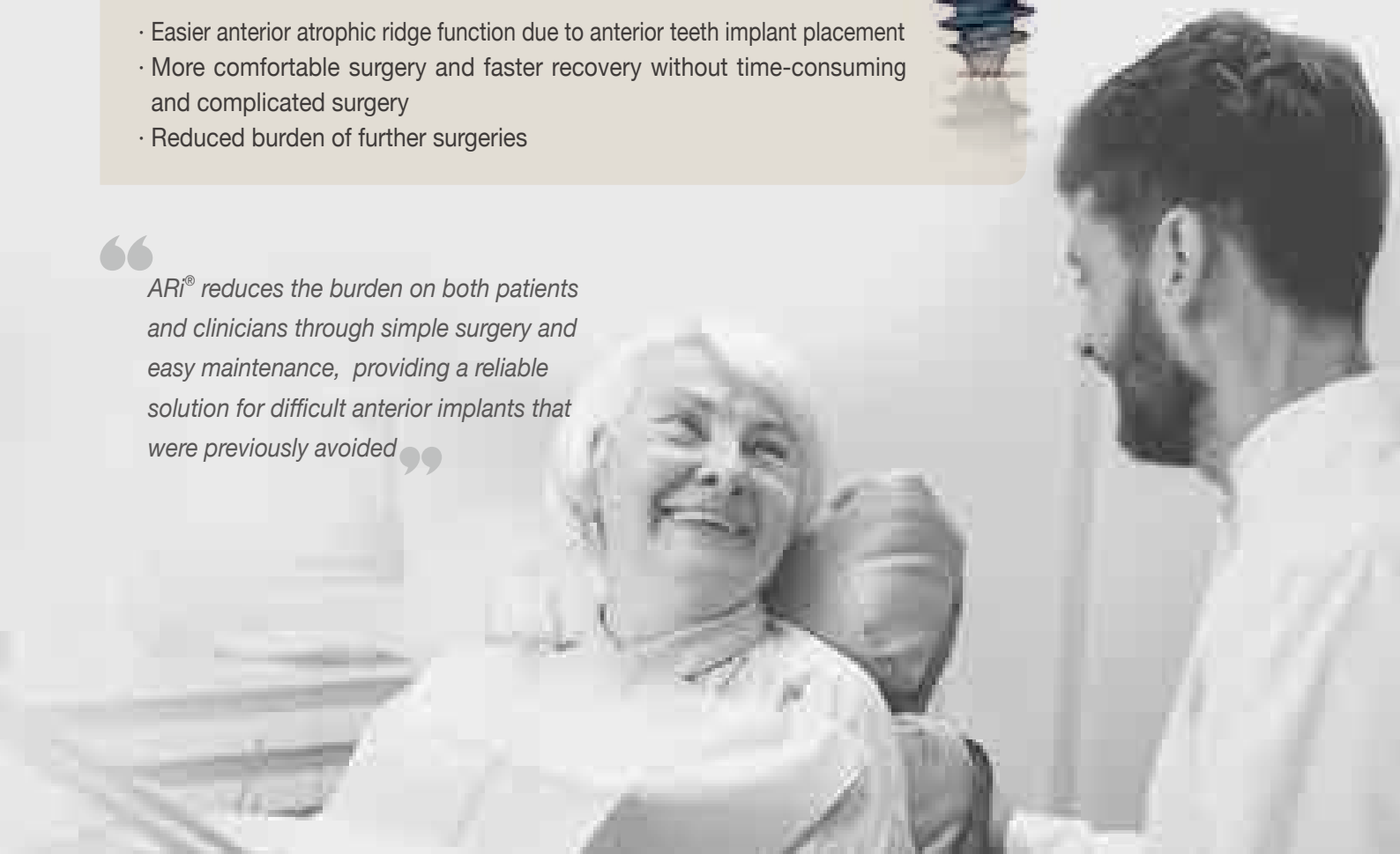
## For Patients

- Easier anterior atrophic ridge function due to anterior teeth implant placement
- More comfortable surgery and faster recovery without time-consuming and complicated surgery
- Reduced burden of further surgeries

*Any Ridge incisor*



*ARI<sup>®</sup> reduces the burden on both patients and clinicians through simple surgery and easy maintenance, providing a reliable solution for difficult anterior implants that were previously avoided*



# A New Game Changer in Anterior Atrophic Ridge



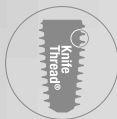
## Strong joint stability

10° external conical hex provides strong bonding with abutment



## Soft Tissue Friendly Design

Rapid regeneration of soft tissue by facilitating generation and proliferation of HGF\*-cells and subsidence prevention function (\*Human Gingival Fibroblast)



## Guaranteed strong initial stability from basal bone without bone volume restoration

- Deep & KnifeThread® design for smooth implantation without bone destruction
- Increased surface area
- Stable stress distribution



## Favorable surface for prevention and management of peri-implantitis

Minimizes adhesion of foreign substances around implants, and easy removal of foreign substances if it occurs (Heights: 4/6/8/10mm)



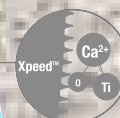
## High strength guaranteed even in narrow zones

200% (2-fold) improvement in strength (compared to our implant system for the narrow zone), and straight body design without stress concentration



## Effective prevention of peri-implantitis

Significantly lower possibility of exposure to oral bacteria due to deep placement of rough surface



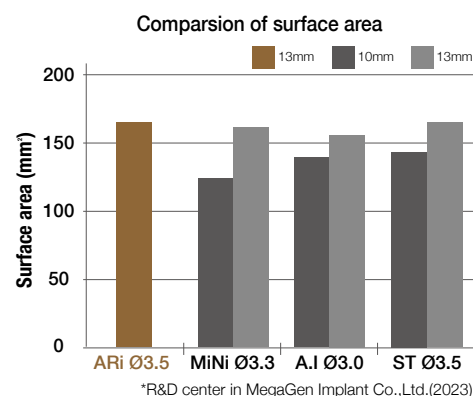
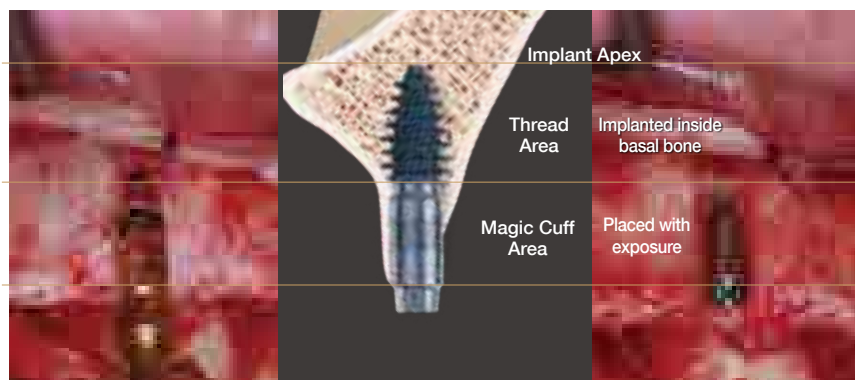
## Strong osseointegration force in basal bone maintains stability even if alveolar bone is lost

Incorporating calcium ions that create bone on S-L-A surface increases rate of osseointegration by more than 15%. Blue surface color is evidence of calcium ions!

# Guaranteed strong initial stability from basal bone without bone volume restoration <sup>1), 2)</sup>

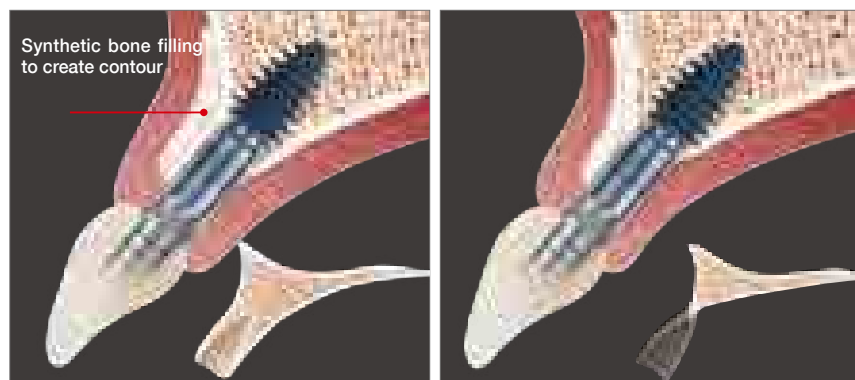
**KnifeThread® located in basal bone zone guarantees higher ISQ value immediately after implantation.**

The application of MegaGen's special Deep & KnifeThread® design secures a high initial stability, even in the basal bone, immediately after implantation. It also increases resistance to compressive force while minimizing the occurrence of shear force.



# Securing long-term stability, even if alveolar bone loss occurs <sup>3)</sup>

The thread section with XPEED® surface treatment, which is implanted in the non-degenerated basal bone, maintains stable strong osseointegration, ensuring long-term implant stability even if the alveolar bone is lost.



The implant maintains strong stability and stable osseointegration even with alveolar bone loss.

- After one year following osseointegrated implant loading, a vertical bone loss of less than 0.1 mm occurred every year (Adell et al., 1981).
- Criteria for implant success: bone loss of 0.2 mm or less per year from first year of loading is acceptable. (Albrektsson T., 1986)



- Many cations are formed on the implant surface due to calcium in the body
- As a result, more PO<sub>4</sub><sup>3-</sup> ions are adsorbed and Ca<sup>2+</sup> ions are re-adsorbed.
- Apatite layer formation similar to bone mineral is promoted and mineralized with hydroxyapatite

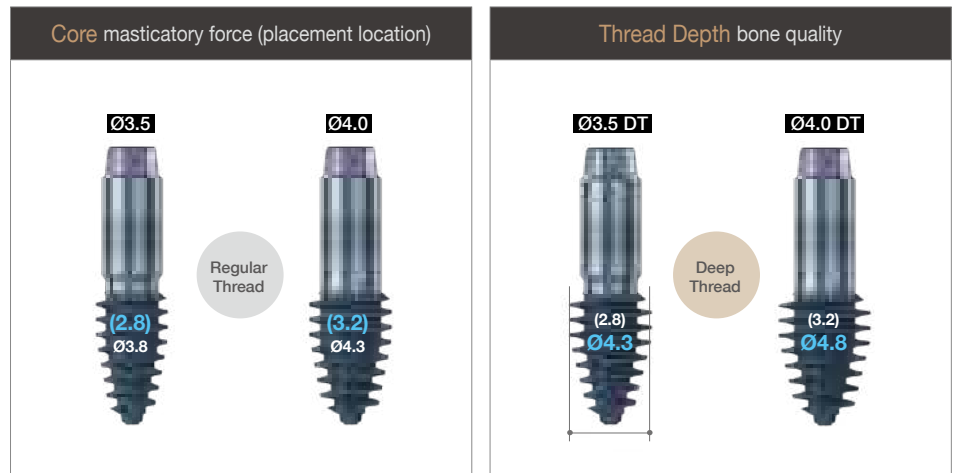
## Article Review

- 1) A total of 256 bicortical screws and 84 blade implants were placed from 2002 to 2007, where 4 and 1 failed, respectively. The treatment success rate was over 98%, and the prosthetic success rate was 100%. (Strecha J., 2010)
- 2) Basal Implant can be an appropriate treatment for severely atrophied ridges where implants can no longer be placed. (Gupta A.D., 2017)
- 3) Implants placed in the basal bone not only enable immediate loading, but also reduce the possibility of failure due to infection because the implant is maintained at a site far from the surgical site. (Ali S.M., 2019)

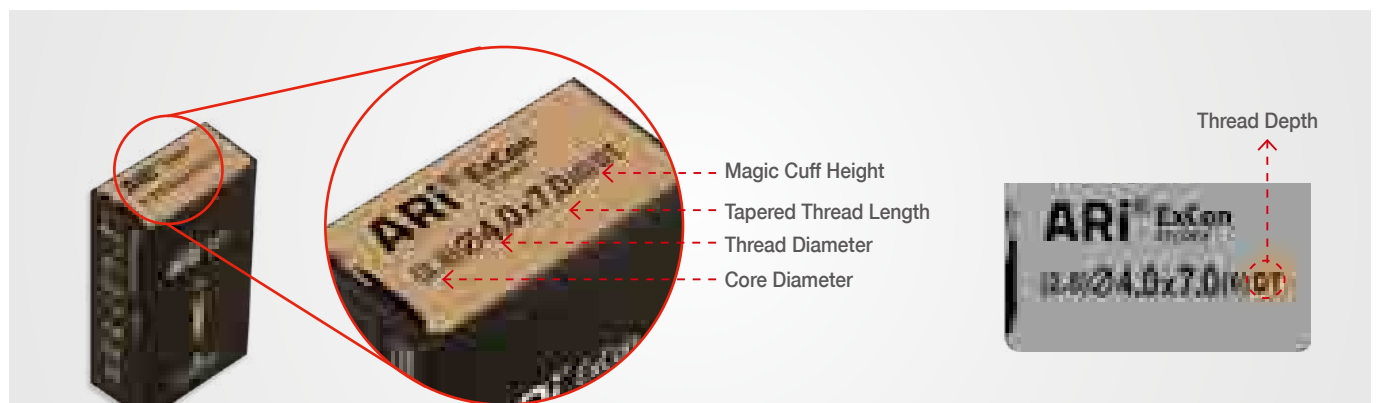
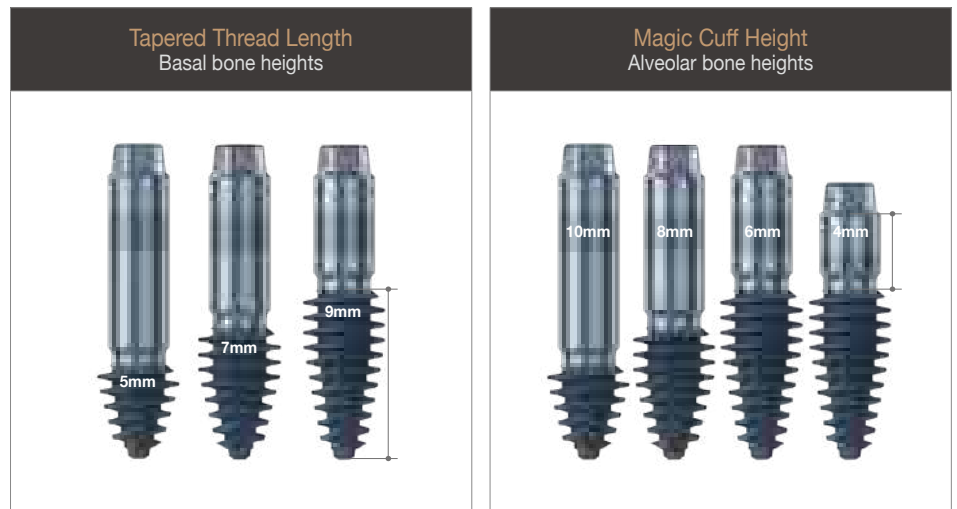
# Various implant options applicable to alveolar and basal bone types

ARi® provides various options depending on the masticatory force (placement location), bone quality, and length of the basal bone and alveolar bone, enabling stable implant placement in any situation.

## Diameter selection Core & Thread Technique



## Length selection Tapered Thread Length & Magic Cuff Height



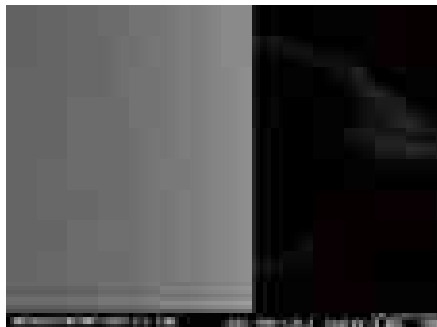
# Implant body design facilitates soft tissue generation, prevents subsidence, and is more effective for post care

The unique implant design supports cell adhesion, prevents continuous subsidence, averts complications such as peri-implantitis and fracture issues that can occur after restoration, and is easy to remove even when peri-implantitis occurs.

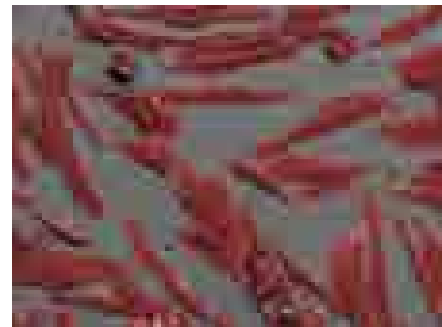
## 1 Better surface for prevention and management of peri-implantitis Machined Magic Cuff design<sup>1), 2), 3), 4)</sup>

Application of XPEED<sup>®</sup> machined surface with Ra (average roughness) of 0.2 μm or less to minimize plaque and bacteria adhesion. Also, easy to remove and manage if complications occur.

XPEED<sup>®</sup> Machined Surface



Fibroblasts Growth



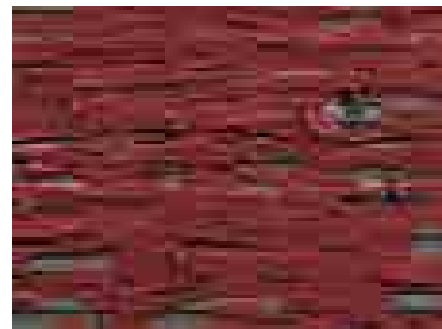
## 2 Celllike<sup>®</sup> grooves facilitate soft tissue creation soft tissue creation and prevent subsidence<sup>5), 6), 7)</sup>

The use of 17 μm micro grooves induces cell attachment to 2mm section below the connection. Plus, a gingival recession limit line is formed to prevent continuous sinking.

Celllike<sup>®</sup> Groove Surface

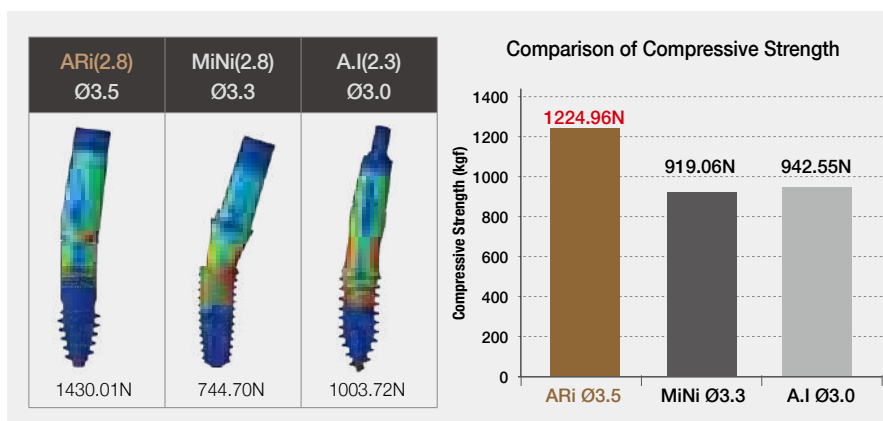


Fibroblasts Growth



## 3 High strength guaranteed even in narrow zones

Maximum strength relative to diameter via dispersion of implant stress concentration section using computer simulation



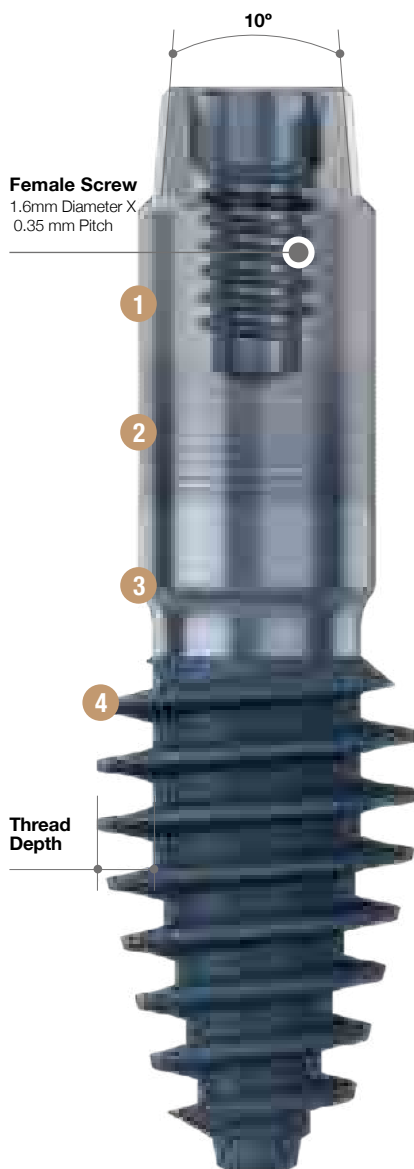
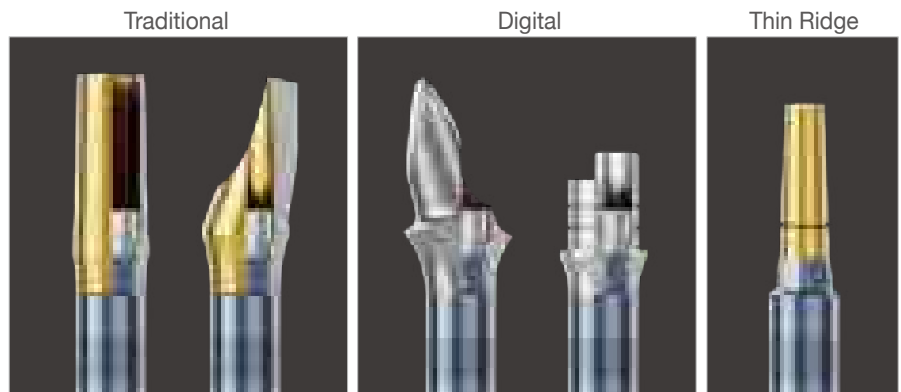
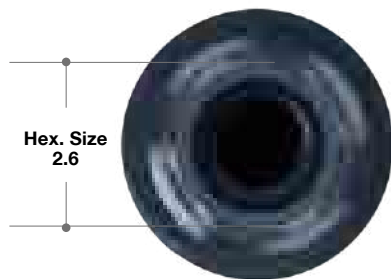
## 4 Clean & Safe Zone preventing exposure to oral bacteria<sup>®</sup>

The possibility of exposure to oral bacteria is significantly lowered by placing the rough surface for fixation deep in the basal bone



# External Conical Hex connection for strong joint stability and prosthetic options

The 10° external conical hex provides a strong bond with the abutment, facilitating conventional, digital, and thin ridge prosthetic options.



|                                      | EZ Post Abutment | Angled Abutment | TiGEN Abutment | ZrGEN Abutment | Solid Abutment |
|--------------------------------------|------------------|-----------------|----------------|----------------|----------------|
| <b>Single crown</b>                  |                  |                 |                |                |                |
| Cement-retained                      | ✓                | ✓               | ✓              | ✓              | ✓              |
| Screw-retained                       | ✓                | ✓               | ✓              | ✓              |                |
| <b>Bridge</b>                        |                  |                 |                |                |                |
| Cement-retained                      | ✓                | ✓               | ✓              | ✓              | ✓              |
| Screw-retained                       |                  |                 |                |                |                |
| <b>Impression</b>                    |                  |                 |                |                |                |
| Implant Level                        | ✓                | ✓               | ✓              | ✓              |                |
| Abutment Level                       |                  |                 |                |                | ✓              |
| <b>Custom</b>                        |                  |                 |                |                |                |
| Custom                               |                  |                 | ✓              | ✓              |                |
| <b>Recommended Tightening Torque</b> |                  |                 |                |                |                |
| Torque (Ncm)                         | 35               | 35              | 35             | 35             | 25             |

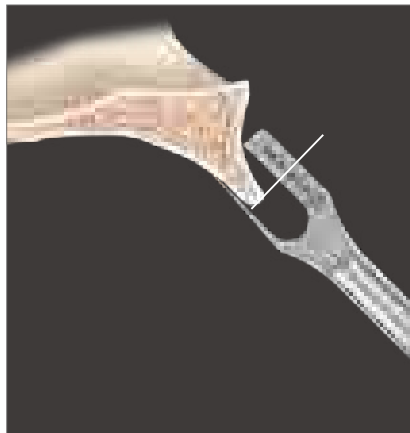
| Article Review |   |
|----------------|---|
| 1)             | As a result of evaluating plaque formation for 3 months on standard (Ra; 0.3 mm) and rough surfaces (Ra; 0.8 mm), fewer cocci were observed on the rough surface, but more mature plaques were observed (Quirynen et al., 1993)                           |
| 2)             | Ra 0.2µm or less (smooth surface) showed no significant change in the total amount of attached bacteria → 0.2µm was suggested as the critical surface roughness (Bollen et al., 1997)   |
| 3)             | When observing the plaque formation during the initial 24 hours on the surface of titanium specimens using SEM, the same amount of bacteria inhabited the smooth surface, while the number was much higher on the rough surface (Rimondini et al., 1997). |
| 4)             | Rough surfaces are difficult to clean, and biofilm regrows quickly due to remaining bacteria (Quirynen & Bollen, 1995)  |
| 5)             | The higher the SFE, the more susceptible to bacterial attachment (Glantz, 1969; Quirynen et al., 1990)  |
| 6)             | Titanium implants with microgrooves in the coronal portion showed firm adhesion to the soft tissue around the implants. (Lee H.J., 2015)  |
| 7)             | The generation and spread of HGF-Cell is maximized in the area of micro grooves of 7.5~20µm. (Patrick W., 2021)   |
| 8)             | Immediate loading is possible on an implant placed in the basal bone, and the possibility of failure due to infection is reduced because the implant is maintained at a site far from the surgical site. (Ali S.M., 2019)                                 |

## ▶▶ Implant Selection and Drilling Sequence



Check total length (cuff + thread length) of implant that can be placed using panoramic picture.

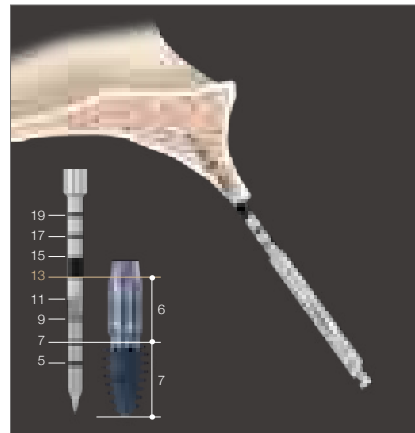
**Ex)** 13mm ~



Measure height of 5 mm thick point of alveolar bone using bone calipers. Measured height is cuff height.

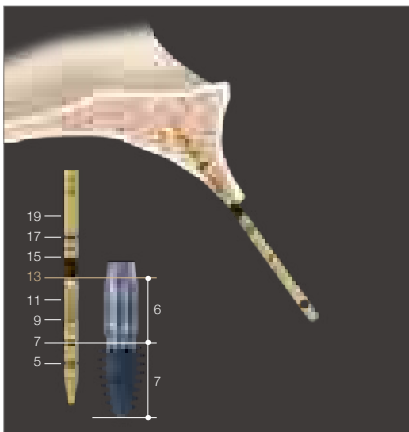
**Ex)** 6mm

**Total 13mm** (Cuff Length 6mm+Thread Length 7mm)



Use lance drill to drill parallel to palatal bone wall to prevent defects in labial direction.

**Ex)** 13mm



Check path and depth of drilled hole using direction indicator.

**Ex)** 13mm

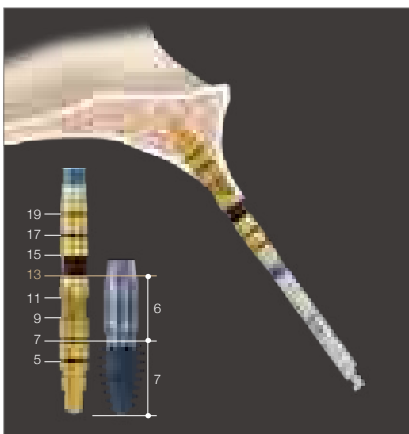


If path of drilled hole does not match, use Lindermann Drill to adjust path.



If bone interference is anticipated for healing abutment or final prosthesis, remove this bone using profile drill.

**Ex)** Drilling depth: Marking line



Perform drilling sequence until final drill.

**Ex)** 13mm

Ø2.5 drill → Ø2.9 drill → (Ø2.9 direction indicator) → sequential drilling until final drill

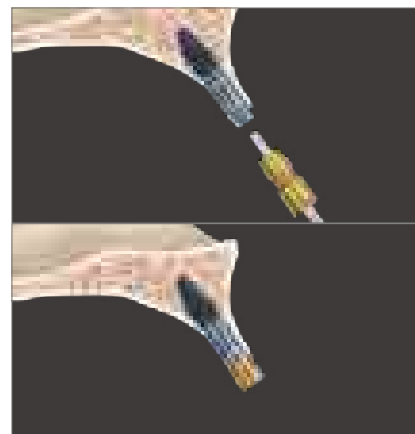


Place implant using handpiece connector.

**Ex)** Place up to interface between implant and mount.

\* Recommended torque: 45Ncm

Less than 80Ncm when using ratchet connector

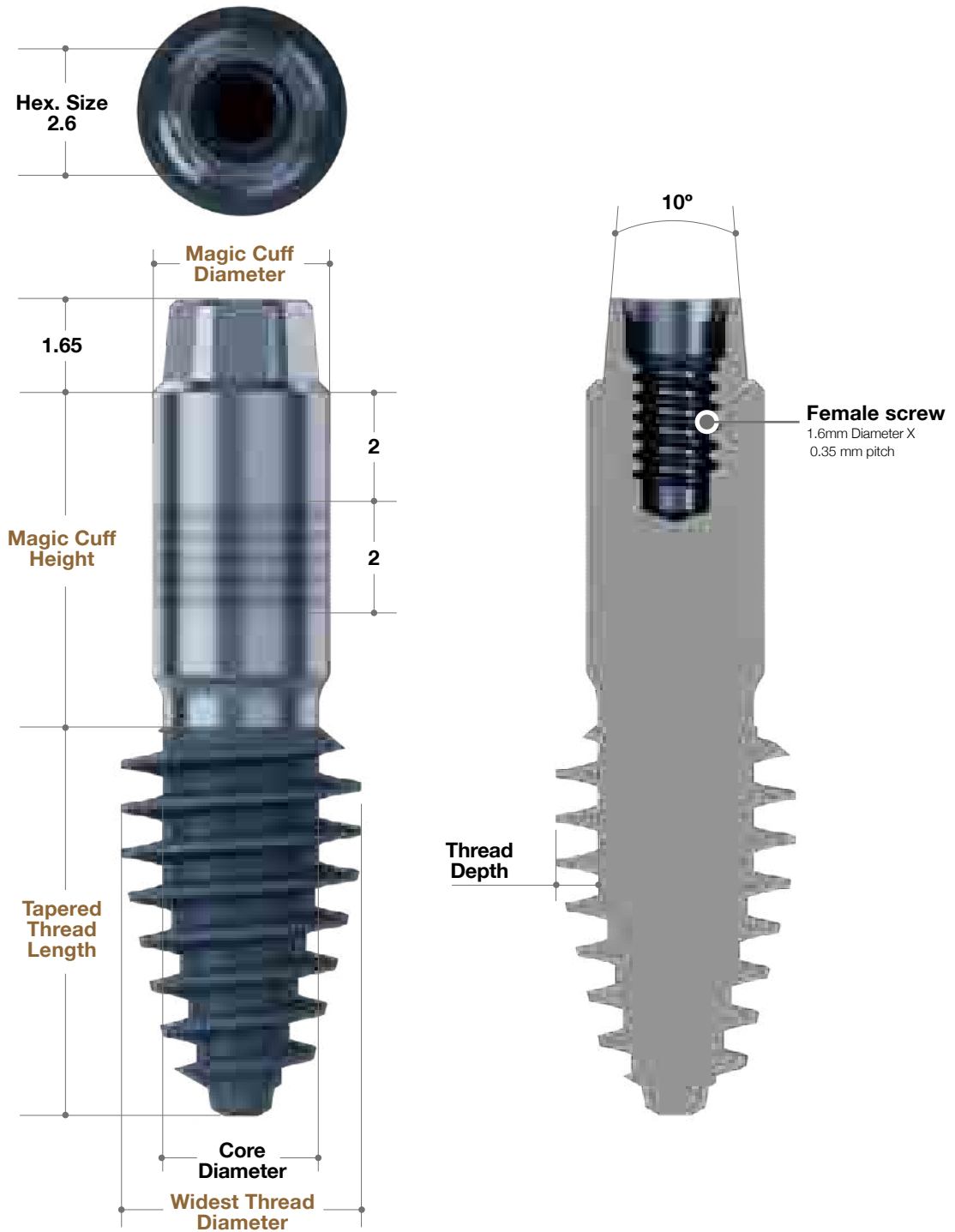


Remove mount and attach healing abutment or cover screw.

\* If reinforcing gingiva volume is needed, add bone grafting material.

# Implant Product & Packaging

## I. Implant Dimension



\*ARi Implant

| Implant Diameter | Core Diameter | Widest Thread Diameter | Thread Depth | Tapered Length | Magic Cuff Height | Magic Cuff Diameter | Hex. Size |
|------------------|---------------|------------------------|--------------|----------------|-------------------|---------------------|-----------|
| Ø3.5             | Ø2.8          | Ø3.8                   | 0.5          | 5/ 7/ 9        | 4/ 6/ 8/(10)      | Ø3.2                | 2.6       |
|                  | Ø2.8          | Ø4.3                   | 0.75         |                |                   |                     |           |
|                  | Ø3.2          | Ø3.8                   | 0.3          |                |                   |                     |           |
| Ø4.0             | Ø3.2          | Ø4.3                   | 0.5          |                |                   |                     |           |
|                  | Ø3.2          | Ø4.8                   | 0.75         |                |                   |                     |           |

# II. Implant Size

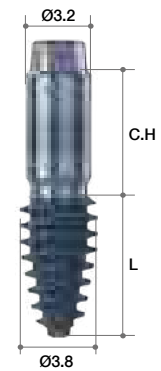
- Core Diameter 2.8

## Ø3.5

(2.8) Ø3.8 x Thread L (C.H)

- Implant Mount is assembled

| Widest Thread Diameter | Core Diameter | Thread Length (mm) | Cuff Height (mm) | Ref.C       |             |
|------------------------|---------------|--------------------|------------------|-------------|-------------|
| Ø3.8                   | Ø2.8          | 5                  | 4                | ARIE283554M |             |
|                        |               |                    | 6                | ARIE283556M |             |
|                        |               |                    | 8                | ARIE283558M |             |
|                        |               | 7                  | 10               | ARIE283550M |             |
|                        |               |                    | 4                | ARIE283574M |             |
|                        |               |                    | 6                | ARIE283576M |             |
|                        |               |                    | 8                | ARIE283578M |             |
|                        |               | 9                  | 10               | ARIE283570M |             |
|                        |               |                    | 4                | ARIE283594M |             |
|                        |               |                    | 6                | ARIE283596M |             |
|                        |               |                    |                  | 8           | ARIE283598M |

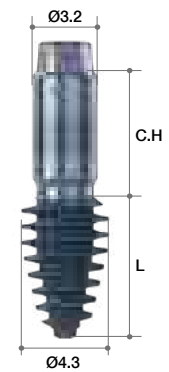


## Ø3.5 Deep Thread

(2.8) Ø4.3 x Thread L (C.H)

- Implant Mount is assembled

| Widest Thread Diameter | Core Diameter | Thread Length (mm) | Cuff Height (mm) | Ref.C       |
|------------------------|---------------|--------------------|------------------|-------------|
| Ø4.3                   | Ø2.8          | 5                  | 4                | ARIE284054M |
|                        |               |                    | 6                | ARIE284056M |
|                        |               |                    | 8                | ARIE284058M |
|                        |               |                    | 10               | ARIE284050M |
|                        |               | 7                  | 4                | ARIE284074M |
|                        |               |                    | 6                | ARIE284076M |
|                        |               |                    | 8                | ARIE284078M |
|                        |               |                    | 10               | ARIE284070M |
|                        |               | 9                  | 4                | ARIE284094M |
|                        |               |                    | 6                | ARIE284096M |
|                        |               |                    | 8                | ARIE284098M |



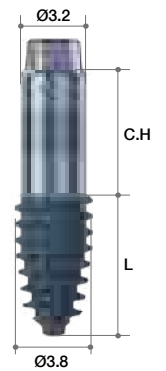
- Core Diameter 3.2

**Ø3.5**

(3.2) Ø3.8 x Thread L (C.H)

- Implant Mount is assembled

| Widest Thread Diameter | Core Diameter | Thread Length (mm) | Cuff Height (mm) | Ref.C       |
|------------------------|---------------|--------------------|------------------|-------------|
| Ø3.8                   | Ø3.2          | 5                  | 4                | ARIE323554M |
|                        |               |                    | 6                | ARIE323556M |
|                        |               |                    | 8                | ARIE323558M |
|                        |               |                    | 10               | ARIE323550M |
|                        |               | 7                  | 4                | ARIE323574M |
|                        |               |                    | 6                | ARIE323576M |
|                        |               |                    | 8                | ARIE323578M |
|                        |               |                    | 10               | ARIE323570M |
|                        |               | 9                  | 4                | ARIE323594M |
|                        |               |                    | 6                | ARIE323596M |
|                        |               |                    | 8                | ARIE323598M |

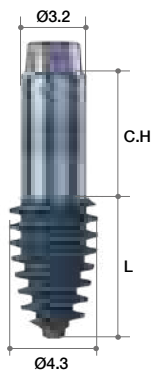


**Ø4.0**

(3.2) Ø4.3 x Thread L (C.H)

- Implant Mount is assembled

| Widest Thread Diameter | Core Diameter | Thread Length (mm) | Cuff Height (mm) | Ref.C       |
|------------------------|---------------|--------------------|------------------|-------------|
| Ø4.3                   | Ø3.2          | 5                  | 4                | ARIE324054M |
|                        |               |                    | 6                | ARIE324056M |
|                        |               |                    | 8                | ARIE324058M |
|                        |               |                    | 10               | ARIE324050M |
|                        |               | 7                  | 4                | ARIE324074M |
|                        |               |                    | 6                | ARIE324076M |
|                        |               |                    | 8                | ARIE324078M |
|                        |               |                    | 10               | ARIE324070M |
|                        |               | 9                  | 4                | ARIE324094M |
|                        |               |                    | 6                | ARIE324096M |
|                        |               |                    | 8                | ARIE324098M |

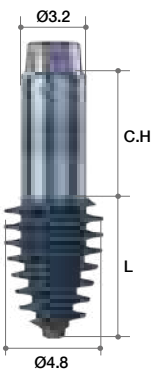


**Ø4.0 Deep Thread**

(3.2) Ø4.8 x Thread L (C.H)

- Implant Mount is assembled

| Widest Thread Diameter | Core Diameter | Thread Length (mm) | Cuff Height (mm) | Ref.C       |
|------------------------|---------------|--------------------|------------------|-------------|
| Ø4.8                   | Ø3.2          | 5                  | 4                | ARIE324554M |
|                        |               |                    | 6                | ARIE324556M |
|                        |               |                    | 8                | ARIE324558M |
|                        |               |                    | 10               | ARIE324550M |
|                        |               | 7                  | 4                | ARIE324574M |
|                        |               |                    | 6                | ARIE324576M |
|                        |               |                    | 8                | ARIE324578M |
|                        |               |                    | 10               | ARIE324570M |
|                        |               | 9                  | 4                | ARIE324594M |
|                        |               |                    | 6                | ARIE324596M |
|                        |               |                    | 8                | ARIE324598M |

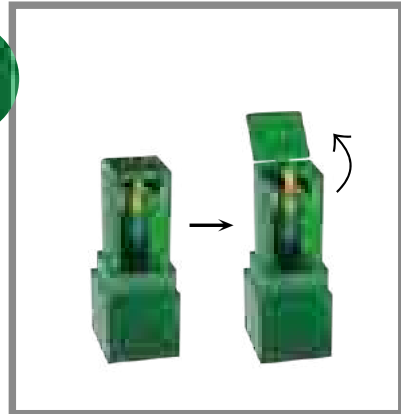


# III. Packaging

- Ampule



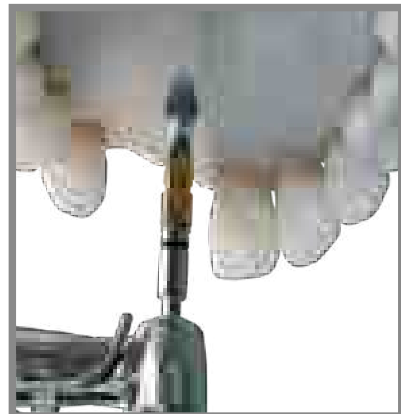
Set long side upwards and push up



Open cover of inner ampule



Pick up Implant by connecting handpiece connector with mount



Implant fixture in drilled hole



Loosen mount Screw and dismantle mount



Attach healing abutment or cover screw to Implant



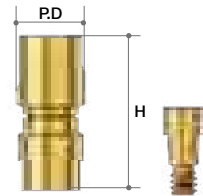
MegaGen ampule is re-usable as building block (after cleaning & sterilization) reducing plastic waste!

# Cover Screw & Healing Abutment

## Implant Mount

- Neck fracture at 120N
- Recommended torque: by hand (5~8Ncm)
- Use hand driver or right angle driver (1.2 Hex)

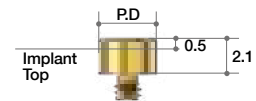
| Profile Diameter | Height (mm) | Ref.C   |
|------------------|-------------|---------|
| Ø4.0             | 9           | ARIEMNT |



## Cover Screw

- Use for submerged-type surgery
- Recommended torque: by hand (5~8Ncm)
- Use hand driver or right angle driver (1.2 Hex)

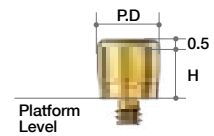
| Profile Diameter | Height (mm) | Ref.C       |
|------------------|-------------|-------------|
| Ø3.4             | 0.5         | ARIECSN3405 |



## Healing Abutment

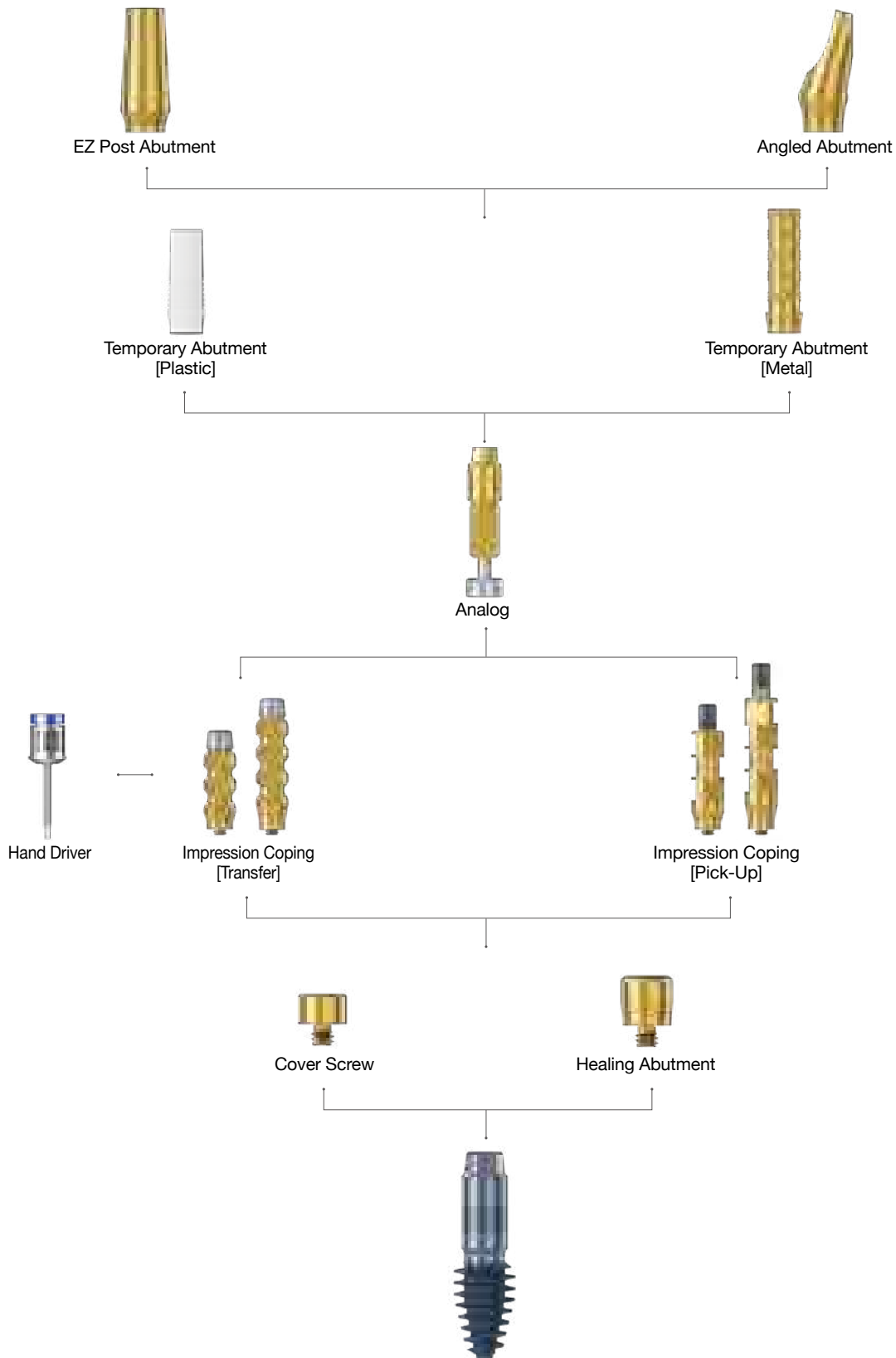
- Use for non-submerged-type or two-stage surgery
- Various diameter and height configurations can be selected according to case
- Proper emergence profile formation during gingival healing
- Recommended torque: by hand (5~8Ncm)
- Use hand driver or right angle driver (1.2 Hex)

| Profile Diameter | Height (mm) | Ref.C      |
|------------------|-------------|------------|
| Ø3.7             | 3           | ARIEHAN353 |
|                  | 4           | ARIEHAN354 |
|                  | 5           | ARIEHAN355 |
|                  | 6           | ARIEHAN356 |
|                  | 7           | ARIEHAN357 |
| Ø4.2             | 3           | ARIEHAN403 |
|                  | 4           | ARIEHAN404 |
|                  | 5           | ARIEHAN405 |
|                  | 6           | ARIEHAN406 |
|                  | 7           | ARIEHAN407 |



# Abutment & Prosthetic Options

## I. Implant Level Prosthesis



## ➔ Impression Copings

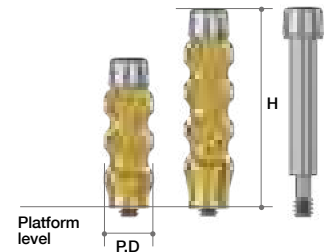
### Impression Coping

(2-Piece, Transfer Type)  
(For Closed-Tray Technique)

- Guide pins(ARIEGPT12/ARIEGPT16)  
included

- Use for closed tray
- Use hand driver (1.2 Hex)

| Profile Diameter | Height (mm) | Ref.C         |
|------------------|-------------|---------------|
| Ø4               | 12          | ARIEICTN4012T |
|                  | 16          | ARIEICTN4016T |



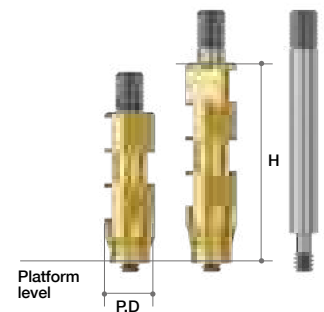
### Impression Coping

(1-piece, Pick-up Type)  
(For Closed-Tray Technique)

- Guide pins(ARIEGPP15/ARIEGPP20)  
included

- Use for open tray
- When taking impressions, it reproduces Implant position accurately in model with design that can guarantee stability
- Use hand driver (1.2 Hex)

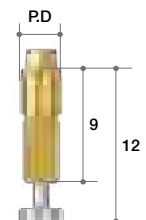
| Profile Diameter | Height (mm) | Ref.C         |
|------------------|-------------|---------------|
| Ø4               | 12          | ARIEICPN4012T |
|                  | 16          | ARIEICPN4016T |



### Analog

- Replacing Implants in gypsum or 3D printing models

| Profile Diameter | Height (mm) | Ref.C    |
|------------------|-------------|----------|
| Ø3.3             | 12          | ARIEALNT |

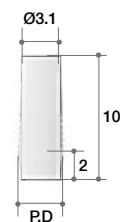


### Temporary Abutment

(Plastic)

- Temporary prosthetics for production of provisional restorations
- Easy to create chairside provisional restoration of aesthetic zone
- Recommended torque: 15Ncm
- Use hand driver or right angle driver (1.2 Hex)

| Profile Diameter | Post Height (mm) | Ref.C          |
|------------------|------------------|----------------|
| Ø3.5             | 10               | ARIETAEPN3510T |
| Ø4.0             |                  | ARIETAEPN4010T |



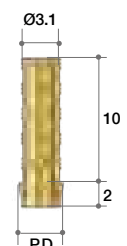
### Temporary Abutment

(Metal)

- Abutment screw (ARIEAS16) included

- Temporary prosthetics for provisional restoration production
- Post design for easy milling work and resin adhesion
- Recommended torque: 25Ncm
- Use hand driver or right angle driver (1.2 Hex)

| Profile Diameter | Post Height (mm) | Ref.C         |
|------------------|------------------|---------------|
| Ø3.5             | 10               | ARIETAN35210T |
| Ø4.0             |                  | ARIETAN40210T |

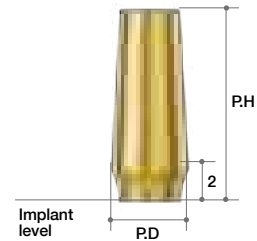


## EZ Post Abutment

- Abutment screw (ARIEAS16) included

- Aesthetic gold color
- Various post heights: 7/ 8/ 10/ 11/ 12mm
- Various profile diameters: Ø3.5/ Ø4.0
- Recommended torque: 35Ncm
- Use hand driver or right angle driver (1.2 Hex)

| Profile Diameter | Post Height (mm) | Ref.C        |
|------------------|------------------|--------------|
| Ø3.5             | 7                | ARIEEPN3507T |
|                  | 8                | ARIEEPN3508T |
|                  | 9                | ARIEEPN3509T |
|                  | 10               | ARIEEPN3510T |
|                  | 11               | ARIEEPN3511T |
|                  | 12               | ARIEEPN3512T |
| Ø4.0             | 7                | ARIEEPN4007T |
|                  | 8                | ARIEEPN4008T |
|                  | 9                | ARIEEPN4009T |
|                  | 10               | ARIEEPN4010T |
|                  | 11               | ARIEEPN4011T |
|                  | 12               | ARIEEPN4012T |



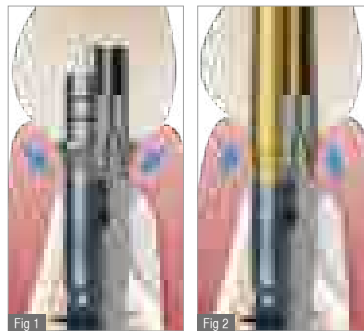
## GALLI Technique

MegaGen would like to appreciate Dr. Oscar Alonso Gonzalez (MD) and Dr. Fabio Galli (Dentist) for recommending the GALLI concept.

- To obtain thick, healthy and stable soft tissue around tooth

### Characteristics of GALLI Technique

1. Form without finish line
2. Conical Shape.
3. Prosthetic Platform Switching



**Fig 1.** In the form of a divergent profile, circular fibers of connective tissue tend to stabilize in the apical direction.

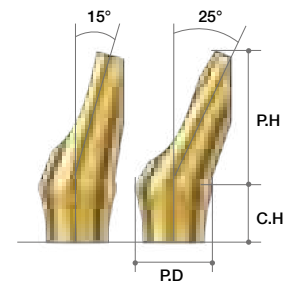
**Fig 2.** In a similar way to natural teeth, this helps to stabilize the circular fibers of connective tissue in the coronal position compared to the existing ones.

## Angled Abutment

- Abutment screw (ARIEAS16) included

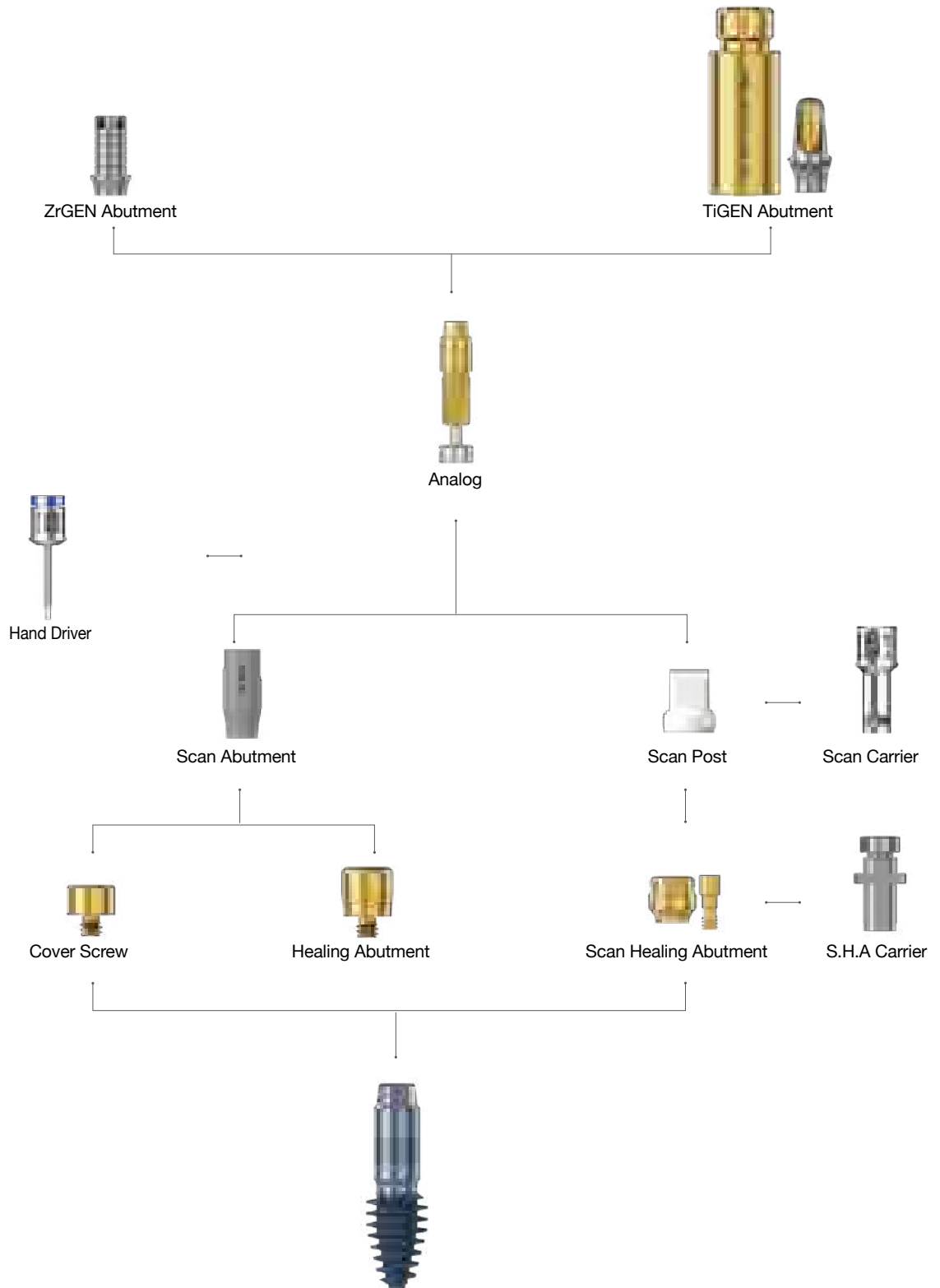
- Aesthetic gold color
- Designed for minimal post modification
- Cuff heights: 2/ 3/ 4/ 5mm(15°), 3/ 4/ 5mm(25°)
- Post angles: 15°/ 25°
- Post axis directions: Hex / Edge
- Recommended torque: 35Ncm
- Use hand driver or right angle driver(1.2 Hex)

| Profile Diameter | Cuff Height(mm) | Post Height(mm) | Type           | Angle | Ref.C          |
|------------------|-----------------|-----------------|----------------|-------|----------------|
| Ø4.0             | 2               | 7               | Hex            | 15°   | ARIEAAHN40215T |
|                  | 3               |                 |                |       | ARIEAAHN40315T |
|                  | 4               |                 |                |       | ARIEAAHN40415T |
|                  | 5               |                 |                |       | ARIEAAHN40515T |
|                  | 2               |                 |                |       | ARIEAAEN40215T |
|                  | 3               |                 |                |       | ARIEAAEN40315T |
|                  | 4               |                 | ARIEAAEN40415T |       |                |
|                  | 5               |                 | ARIEAAEN40515T |       |                |
|                  | 3               |                 | ARIEAAHN40325T |       |                |
|                  | 4               |                 | ARIEAAHN40425T |       |                |
|                  | 5               |                 | ARIEAAHN40525T |       |                |
|                  | 3               |                 | ARIEAAEN40325T |       |                |
|                  | 4               |                 | ARIEAAEN40425T |       |                |
|                  | 5               |                 | ARIEAAEN40525T |       |                |



# I. Implant Level Prosthesis

## 1. Implant Level Prosthesis\_Digital



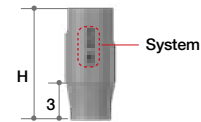
# ➔ Abutment Option

## Scan Abutment

- Abutment screw (ARIEAS16) Included

- For chairside / Labside
- Spare abutment screw included
- Supporting Dental CAD
  - 3Shape / exocad / Dental Wings
- Recommended torque: by hand (5~8Ncm)
- Use hand driver or right angle driver (1.2 Hex)

| Profile Diameter | Height (mm) | Ref.C        |
|------------------|-------------|--------------|
| Ø4.0             | 9           | ARIESAN4009T |
|                  | 13          | ARIESAN4013T |

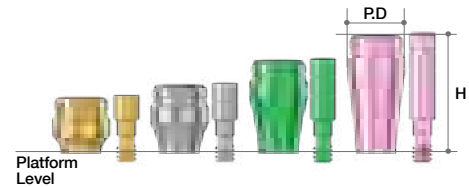


## Scan Healing Abutments

- Abutment Screw included.(ARIEHS1604/ ARIEHS1605/ARIEHS1607/ ARIEHS1609)

- Scannable Healing Abutment.
- For accurate scanning, Scan Healing Abutment must be exposed at least 2.0mm from surgical site.
- Profile Diameter can be checked by the number of Groove.
  - Profile Diameter : Ø4 → Groove : 0ea
  - Profile Diameter : Ø5 → Groove : 1ea
- Height can be checked by the number of Notch.
  - Height : 4mm → Notch : 0ea
  - Height : 5mm → Notch : 1ea
  - Height : 7mm → Notch : 2ea
  - Height : 9mm → Notch : 3ea
- Recommend torque : By Hand (5~8Ncm)

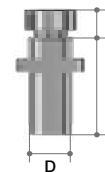
| Profile Diameter | Height (mm) | Ref.C        |
|------------------|-------------|--------------|
| Ø4.0             | 4           | ARIESHN4004T |
|                  | 5           | ARIESHN4005T |
|                  | 7           | ARIESHN4007T |
|                  | 9           | ARIESHN4009T |
| Ø5.0             | 4           | ARIESHN5004T |
|                  | 5           | ARIESHN5005T |
|                  | 7           | ARIESHN5007T |
|                  | 9           | ARIESHN5009T |



## S.H.A Carrier

- It is used by fastening it to the head of the scan healing abutment.
- It is used when transporting the S.H.A Carrier to the fixture after fastening it to the Scan Healing Abutment.

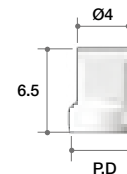
| Diameter | Length (mm) | Ref.C   |
|----------|-------------|---------|
| Ø4.0     | 10          | SHC4010 |
|          | 14          | SHC4014 |
| Ø5.0     | 10          | SHC5010 |
|          | 14          | SHC5014 |



## Scan Post

- Scan Healing Abutment should be exposed 2.0mm from the surgical site for accurate scanning. Scanning would be much easier if you connect Scan Post when scanning seems difficult due to less exposure of Scan Healing Abutment or other conditions.
- Select Scan Post based on the diameter of Scan Healing Abutment.
- Scan Post is a disposable product.
- 1 set consists of 10 Scan Posts.

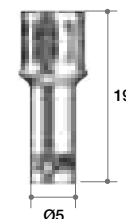
| Profile Diameter | Height (mm) | Ref.C      |
|------------------|-------------|------------|
| Ø4.0             | 6.5         | SP4007.MTN |
| Ø5.0             |             | SP5007.MTN |



## Scan Post Carrier

- It is used by fastening it to the head of the scan post.
- It is used when transporting the scan post to the fixture after fastening it to the scan healing abutment.

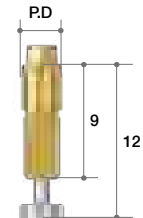
| Profile Diameter | Height(mm) | Ref.C |
|------------------|------------|-------|
| Ø5.0             | 19         | SPC16 |



## Analog

- Replacing Implants in gypsum or 3D printing models

| Profile Diameter | Height (mm) | Ref.C    |
|------------------|-------------|----------|
| Ø3.3             | 12          | ARIEALNT |

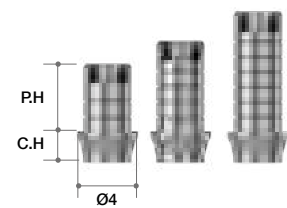


## ZrGEN Abutment

- Abutment screw (ARIEAS16) Included

- Titanium base
- Abutment 10ea = 1 set
- Extra abutment screw provided
- Supporting Dental CAD
  - 3Shape / exocad / Dental Wings
- Available milling machines
- BX5 / ARUM DENTISTRY
- Post height can be confirmed by number of grooves
  - Post height: 4.5mm → 2 grooves
  - Post height: 5mm → 3 grooves
  - Post height: 6mm → 4 grooves
  - Post height: 8mm → 6 grooves
- Recommended torque: 35Ncm

| Profile Diameter | Cuff Height (mm) | Post Height (mm) | Ref.C           |
|------------------|------------------|------------------|-----------------|
| Ø4.0             | 2                | 4.5              | ARIEZGN4025.MTN |
|                  | 3                |                  | ARIEZGN4035.MTN |
|                  | 4                |                  | ARIEZGN4045.MTN |
|                  | 2                | 6                | ARIEZGN4026.MTN |
|                  | 3                |                  | ARIEZGN4036.MTN |
|                  | 4                |                  | ARIEZGN4046.MTN |
|                  | 2                | 8                | ARIEZGN4028.MTN |
|                  | 3                |                  | ARIEZGN4038.MTN |
|                  | 4                |                  | ARIEZGN4048.MTN |

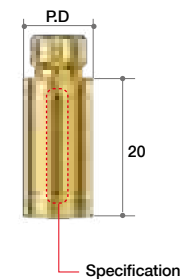


## TiGEN Abutment

- Abutment screw (ARIEAS16) Included

- Pre-milled abutment
- Abutments 10ea = 1 set
  - Extra abutment screw provided
- Available dental CAD
- 3 Shape / exocad
- Available milling machines
  - BX5 / ARUM DENTISTRY
- Use hand driver or right angle driver (1.2 Hex)
- Recommended torque: 35Ncm

| Profile Diameter | Cuff Height (mm) | Ref.C           |
|------------------|------------------|-----------------|
| Ø10              | 20               | ARIETGN1020.MTN |
| Ø12              |                  | ARIETGN1220.MTN |

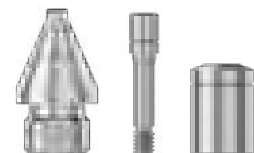


## Reverse Jig Connector

- Milling screws exclusively for Reverse Jig Connector are included(ARIERJMS).

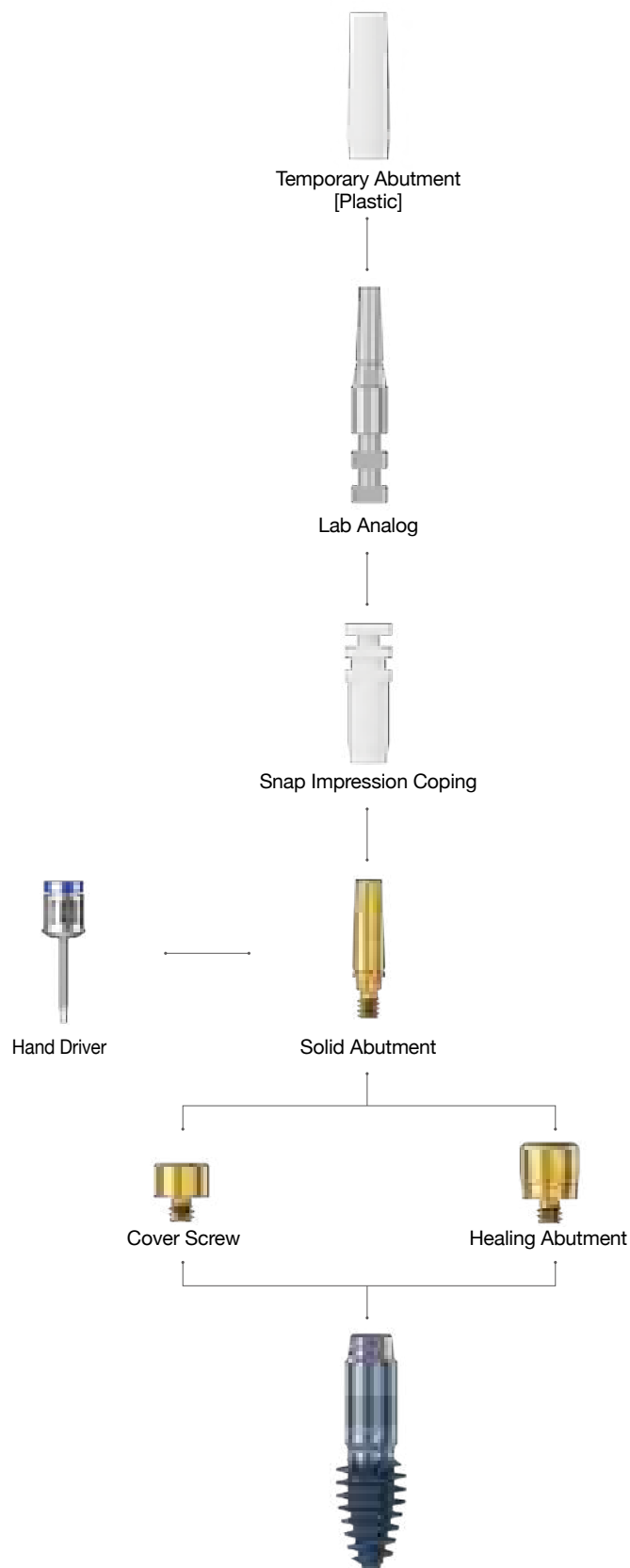
- Available milling machines
  - BX5 / MANIX / ARUM DENTISTRY(Coming Soon)
- Recommended Torque
  - 35Ncm
  - Dedicated Driver (DP-RV-TORQ-DRV) (option)
- When Connected counterpart to Reverse Jig use Allen Wrench
  - Allen Key Size : 2.5mm
  - Dedicated Wrench (DP-HEX-TWLENCH) (option)

| Type | Ref.C        |
|------|--------------|
| Hex  | ARIETGRJN00P |



## II. Abutment Level Prosthesis

# 1. Solid Abutment & Components

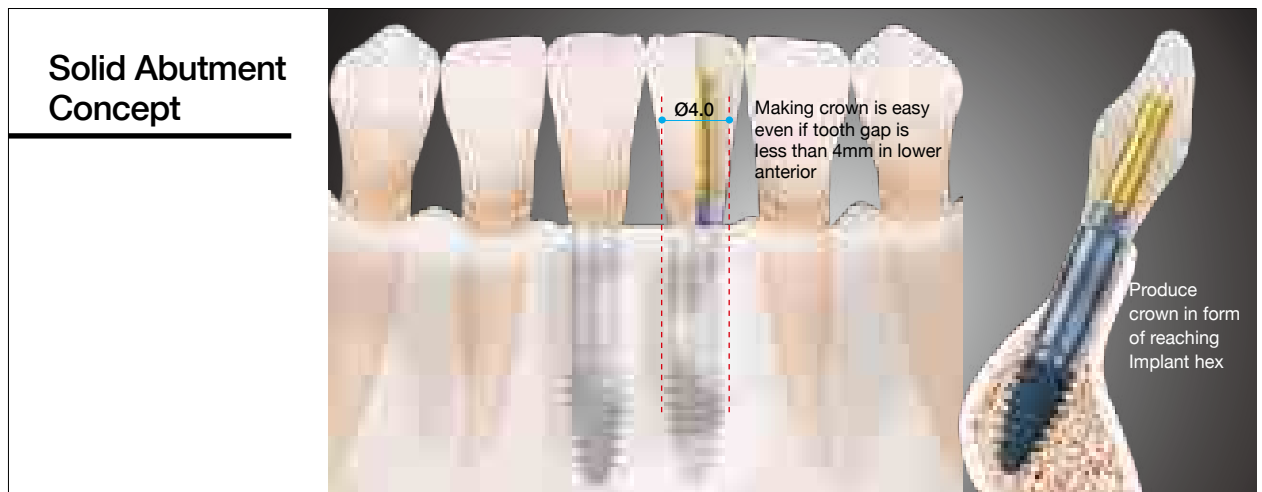
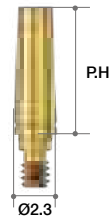


## ➔ Solid Abutment Option

### Solid Abutment

- Abutment for manufacturing cement-retained restoration
- Use for teeth with narrow interdental spaces, such as mandibular anterior teeth
- One body type (abutment + screw)
- Take impression after abutment is completely attached to Implant in patient's mouth
- Use hand driver or right angle driver (1.2 Hex)
- Recommended torque: 25Ncm

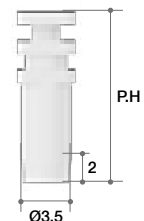
| Profile Diameter | Post Height (mm) | Ref.C      |
|------------------|------------------|------------|
| Ø2.3             | 5                | ARIESA2305 |
|                  | 7                | ARIESA2307 |
|                  | 9                | ARIESA2309 |



### Snap Impression Coping

- In case of milling solid abutment, proceed with direct impression instead of snap impression coping

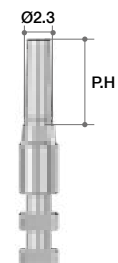
| Profile Diameter | Post Height (mm) | Ref.C       |
|------------------|------------------|-------------|
| Ø3.5             | 10               | ARIESIC2305 |
|                  | 12               | ARIESIC2307 |
|                  | 14               | ARIESIC2309 |



### Lab Analog

- Fasten on top of solid abutment when taking impression
- In case of milling solid abutment, proceed with direct impression instead of snap impression coping

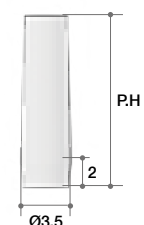
| Profile Diameter | Post Height (mm) | Ref.C      |
|------------------|------------------|------------|
| Ø2.3             | 5                | ARIELA2305 |
|                  | 7                | ARIELA2307 |
|                  | 9                | ARIELA2309 |



### Temporary Abutment (Plastic)

- Temporary prosthetics for production of provisional restorations
- Easy to create chairside provisional restoration for aesthetic zone

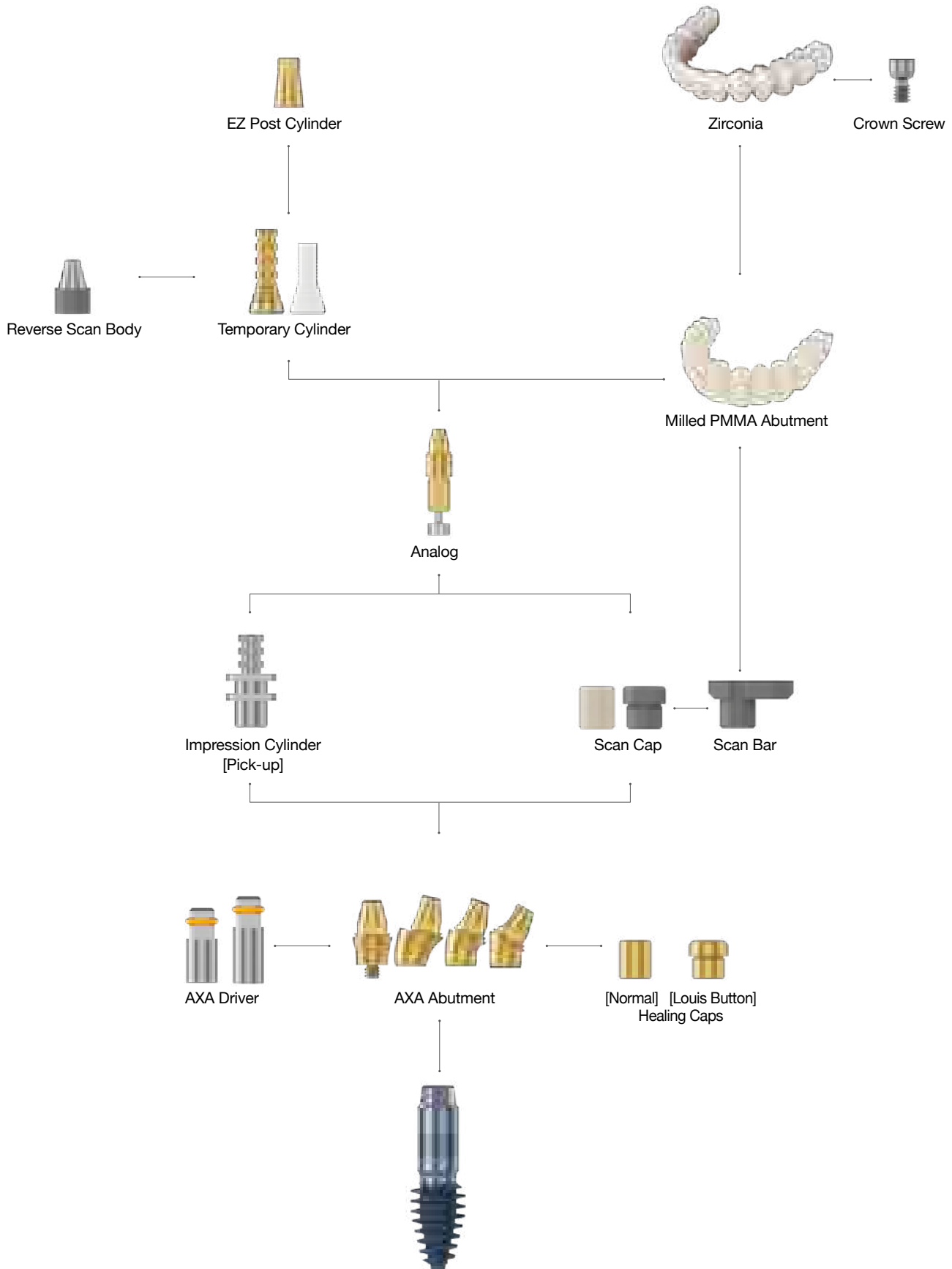
| Profile Diameter | Post Height (mm) | Ref.C        |
|------------------|------------------|--------------|
| Ø3.5             | 10               | ARIETASA2305 |
|                  | 12               | ARIETASA2307 |
|                  | 14               | ARIETASA2309 |



## II. Abutment Level Prosthesis

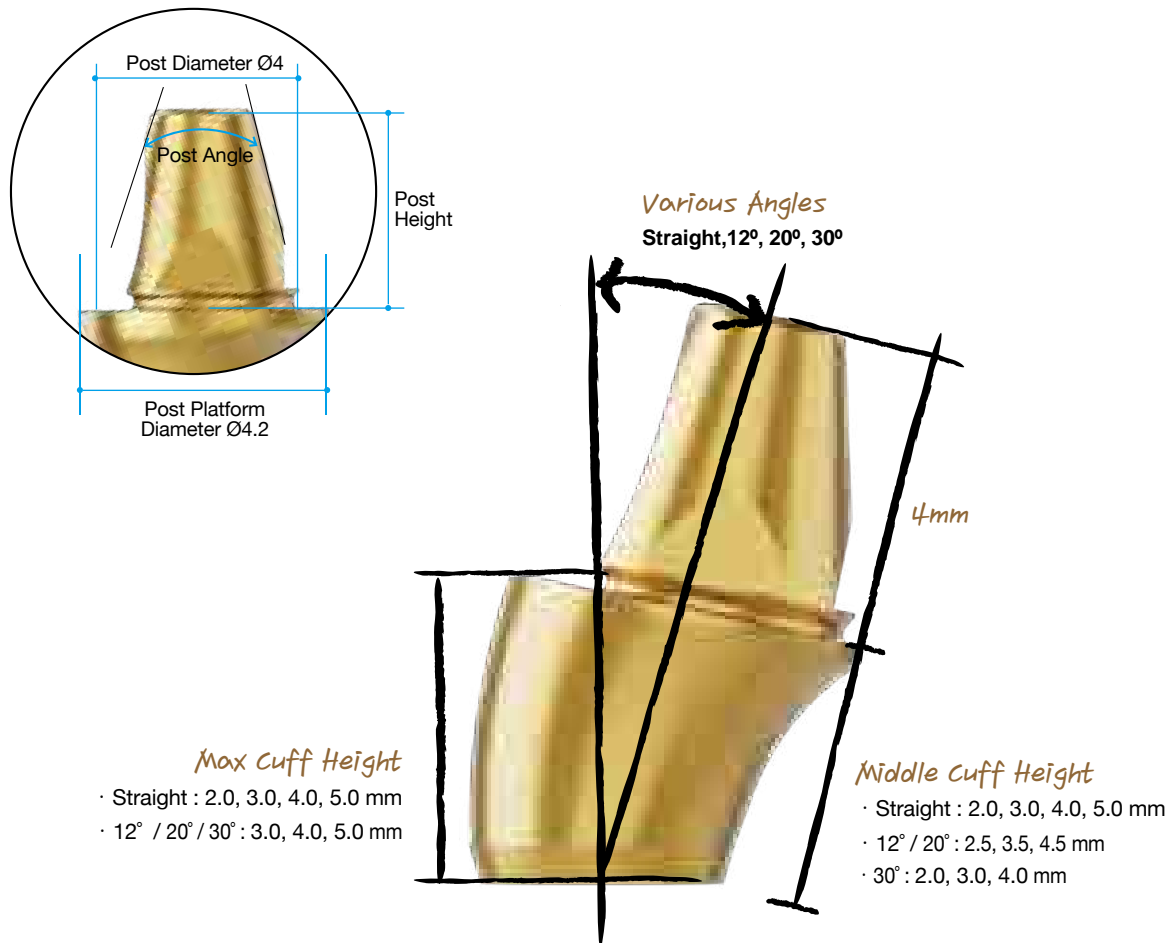
# 2. AXA Abutment & Components

(All-on-X Abutment)



## ►► AXA Abutment

New advanced design concept for All-on-X solution



### Benefit

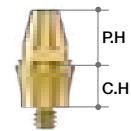
1. The post part is longer than the existing multi-unit abutment, so it can be stably connected with the prosthesis.
2. Cylinder screw loosening and strength has been developed (M1.4 → M1.6)
3. Performance improvement through optimized scan cap shape
4. Direct crown connection is possible through crown screw
5. Various prosthetic solutions available (CRP, SRP, SCRPP, Bar denture)

## ➔ AXA Abutment Option

### AXA Abutment (Straight)

- Use with AXA Driver
- 1 piece type
- Recommend torque : 25Ncm

| Cuff Height (mm) |  | Ref.C       |
|------------------|--|-------------|
| 2                |  | AXARIN42400 |
| 3                |  | AXARIN43400 |
| 4                |  | AXARIN44400 |
| 5                |  | AXARIN45400 |

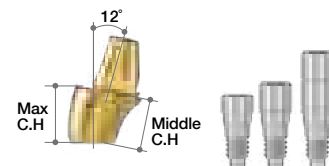


### AXA Abutment (12°)

- Abutment Screw (AXARIAS1603/AXARIAS1604/AXARIAS1605) included

- Recommend torque : 25Ncm

| Cuff Height (mm) |             | Type | Ref.C        |
|------------------|-------------|------|--------------|
| Max Cuff         | Middle Cuff |      |              |
| 3                | 2.5         | Hex  | AXARIN43410T |
| 4                | 3.5         |      | AXARIN44410T |
| 5                | 4.5         |      | AXARIN45410T |

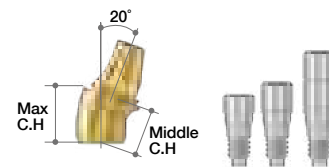


### AXA Abutment (20°)

- Abutment Screw (AXARIAS1603/AXARIAS1604/AXARIAS1605) included

- Recommend torque : 25Ncm

| Cuff Height (mm) |             | Type | Ref.C        |
|------------------|-------------|------|--------------|
| Max Cuff         | Middle Cuff |      |              |
| 3                | 2.5         | Hex  | AXARIN43420T |
| 4                | 3.5         |      | AXARIN44420T |
| 5                | 4.5         |      | AXARIN45420T |

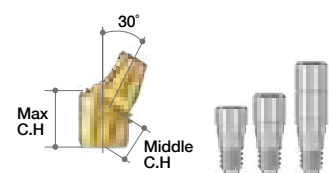


### AXA Abutment (30°)

- Abutment Screw (AXARIAS1603/AXARIAS1604/AXARIAS1605) included

- Recommend torque : 25Ncm

| Cuff Height (mm) |             | Type | Ref.C        |
|------------------|-------------|------|--------------|
| Max Cuff         | Middle Cuff |      |              |
| 3                | 2           | Hex  | AXARIN43430T |
| 4                | 3           |      | AXARIN44430T |
| 5                | 4           |      | AXARIN45430T |

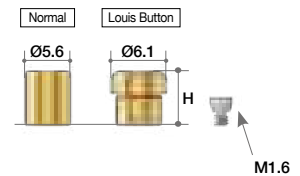


## ➔ Components for AXA Abutment (Continued)

### Healing Cap

- Healing Cap Screw (AXHCS16) included
- The size of the Healing Cap is selected depending on the amount of soft tissue or type of restoration.
- Recommend torque : By Hand (5~8Ncm)

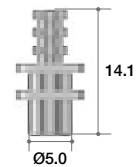
| Height (mm) | Type         | Ref.C      |
|-------------|--------------|------------|
| 6           | Normal       | AXHCS504T  |
|             | Louis Button | AXHCLS504T |



### Impression Cylinder (Pick-up)

- Guide Pin (AXGPP10) included
- Used when making impressions from the abutment level

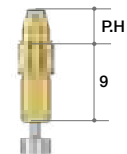
| Height (mm) | Ref.C     |
|-------------|-----------|
| 14.1        | AXICS504T |



### Analog

- Analog Screw (ALS18) included
- Used instead of Multi-unit Abutment in Working Model
- Used as RP Analog in 3D Printed Working Model

| Post Height (mm) | Ref.C    |
|------------------|----------|
| 4                | AXAL404T |



### Temporary Cylinder

- Cylinder Screw (AXCS16) included
- Used when making Acrylic Provisional Restoration
- The groove of the Post Cylinder holds the resin strongly
- Back-up Screw Included
- Recommended Torque: 25Ncm

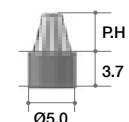
| Type     | Ref.C      |
|----------|------------|
| Standard | AXTCS504T  |
| Plastic  | AXTCSP504T |



### Reverse Scan

- Cylinder Screw (AXCS16) included
- For chairside / Labside
- Supporting Dental CAD
  - 3Shape / exocad / Dental Wings
- Recommended torque: by hand (5~8Ncm)

| Post Height (mm) | Ref.C     |
|------------------|-----------|
| 4                | AXRSS504T |

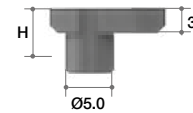


## ➔ Components for AXA Abutment

### Scan Bar

- Cylinder Screw (AXCS16) included
- For chairside / Labside
- Supporting Dental CAD
  - 3Shape / exocad / Dental Wings
- Recommended torque: by hand (5~8Ncm)

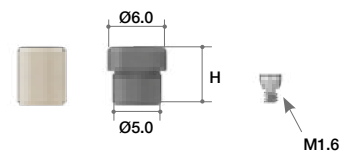
| Height (mm) | Ref.C     |
|-------------|-----------|
| 7.1         | AXSBS504T |



### Scan Cap

- Healing Cap Screw (AXHCS16) included
- For chairside / Labside
- Supporting Dental CAD
  - 3Shape / exocad / Dental Wings
- Recommended torque: by hand (5~8Ncm)

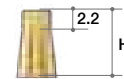
| Height (mm) | Ref.C      |
|-------------|------------|
| 6           | AXSCSP504T |



### EZ Post Cylinder

- Cylinder Screw (AXCS16) included
- Recommended torque: 25Ncm

| Height (mm) | Ref.C    |
|-------------|----------|
| 7           | AXEPC404 |

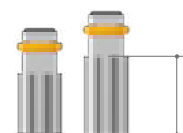


### AXA Driver

(Ratchet type)

- Use to torque straight type AXA Abutments.
- Pick-up available

| Length (mm) | Ref.C     |
|-------------|-----------|
| 9           | MAXDR320S |
| 15          | MAXDR320L |



### Torque Adapter

| Type                            | Ref.C    |
|---------------------------------|----------|
| Torque Wrench Adapter (Ratchet) | *TTAR100 |

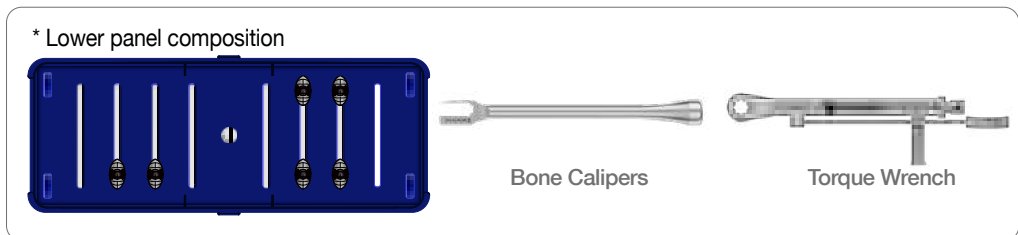


(\*) Separate sales item










# ARi Kit

## I. Surgical Kit

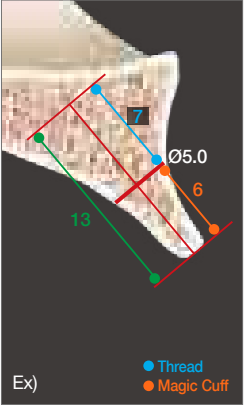
Ref.C  
MKARI3000M



## ▶▶ Drilling Protocols

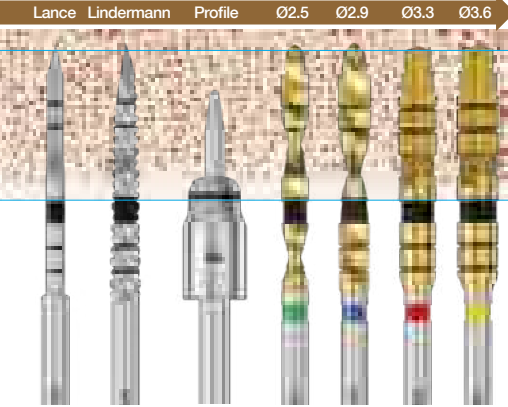
|     | Lance Drill   | Lindermann Drill  | Profile Drill   | Shaping Drills  |   |   |   |   |   |
|-----|---|---|---|---|---|---|---|---|---|
|     | Ø1.6  | Ø2.5  | Ø4.0  | Ø2.5  | Ø2.9  | Ø3.3  | Ø3.6  | Ø3.9  | Ø4.3  |
|     |  |  |  |  |  |  |  |  |  |
| rpm | 800~1000  |   | 300   | 800~1000  |   |   |   |   |   |

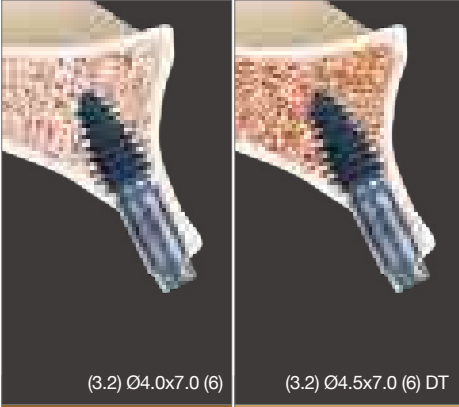
### Maxilla



Ex)

- Thread
- Magic Cuff

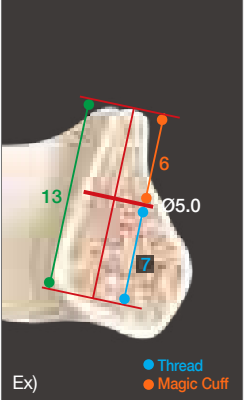




Normal

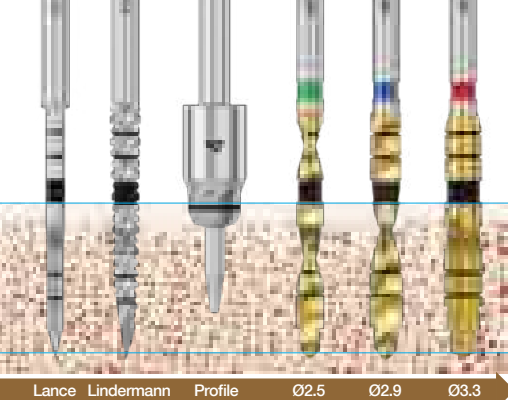
Soft

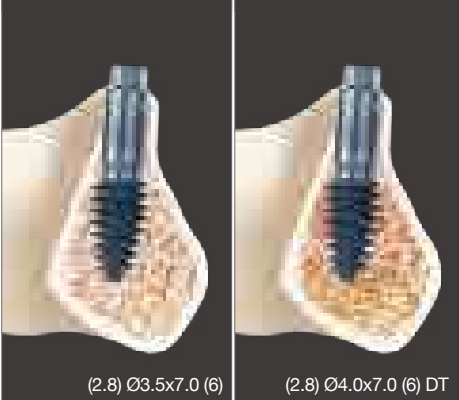
### Mandible



Ex)

- Thread
- Magic Cuff





\*When placing Ø4.0 implant in mandible, implant should be placed after sequential drilling up to Ø3.9 drill

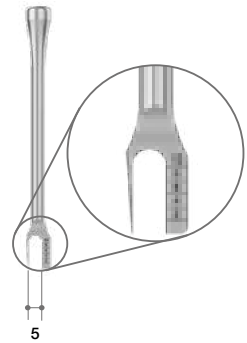
\*According to bone density, implant placement should be done after under or over-drilling

## ➔ Surgical Kit Components (Continued)

### Bone Calipers

- Use to diagnose Magic Cuff height of Implant to be implanted

| Width(mm) | Length(mm) | Ref.C     |
|-----------|------------|-----------|
| 5         | 10         | ARIBC5010 |

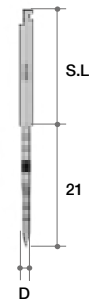


### Lance Drill

- For accurate drilling at diagnosed location
- Laser markings for checking depth from 5 to 19 mm

| Diameter | Shank Length (mm) | Ref.C       |
|----------|-------------------|-------------|
| Ø1.6     | 15                | *ARILD1621S |
|          | 20                | ARILD1621M  |
|          | 25                | *ARILD1621L |

(\*) Separate sales item



### Direction Indicator

- For checking initial drill path and drill depth
- Laser markings for depth verification

| Diameter | Ref.C  |
|----------|--------|
| Ø1.6     | ARID16 |
| Ø2.9     | ARID29 |

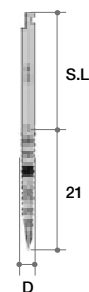


### Lindermann Drill

- Use for path correction when drilling hole path does not match

| Diameter | Shank Length (mm) | Ref.C         |
|----------|-------------------|---------------|
| Ø2.5     | 15                | *ARILDMD2521S |
|          | 20                | ARILDMD2521M  |
|          | 25                | *ARILDMD2521L |

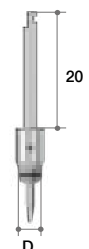
(\*) Separate sales item



### Profile Drill

- For bone removal when healing abutment / final prosthesis is anticipated to interfere with surrounding bone
- Laser markings for depth verification

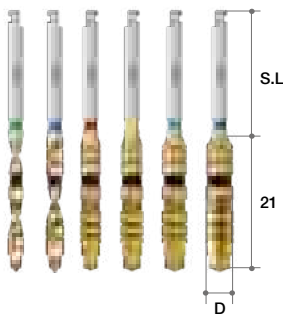
| Diameter | Ref.C    |
|----------|----------|
| Ø4.0     | ARIEPD40 |



## ➔ Surgical Kit Components

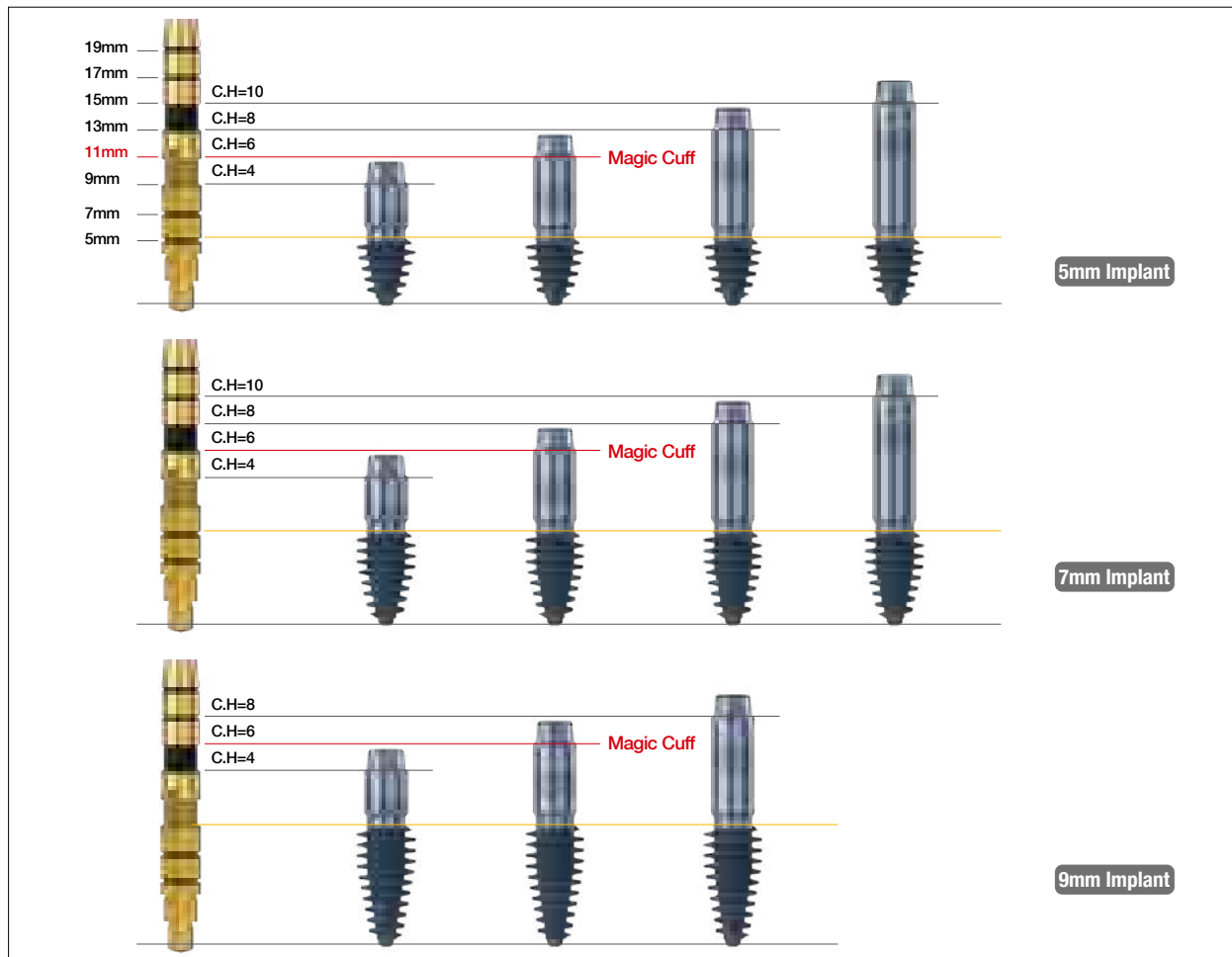
### Shaping Drill

- Depth markings from 5 to 19mm
- Dual marking system (grooves and laser markings) menas clinician can easily recognize drilling depth during surgery
- Excellent corrosion resistance and abrasion resistance with TiN coating
- \* Guided drill length does not include Y-length



| Diameter | Shank Length (mm) | Ref.C       | Diameter                | Shank Length (mm) | Ref.C       |
|----------|-------------------|-------------|-------------------------|-------------------|-------------|
| Ø2.5     | 15                | *ARISD2521S | Ø2.5                    | 25                | *ARISD2521L |
| Ø2.9     |                   | *ARISD2921S | Ø2.9                    |                   | *ARISD2921L |
| Ø3.3     |                   | *ARISD3321S | Ø3.3                    |                   | *ARISD3321L |
| Ø3.6     |                   | *ARISD3621S | Ø3.6                    |                   | *ARISD3621L |
| Ø3.9     |                   | *ARISD3921S | Ø3.9                    |                   | *ARISD3921L |
| Ø4.3     |                   | *ARISD4321S | Ø4.3                    |                   | *ARISD4321L |
| Ø2.5     | 20                | ARISD2521M  | (*) Separate sales item |                   |             |
| Ø2.9     |                   | ARISD2921M  |                         |                   |             |
| Ø3.3     |                   | ARISD3321M  |                         |                   |             |
| Ø3.6     |                   | ARISD3621M  |                         |                   |             |
| Ø3.9     |                   | ARISD3921M  |                         |                   |             |
| Ø4.3     |                   | ARISD4321M  |                         |                   |             |

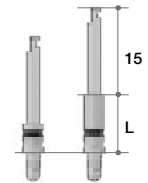
### ▶▶ Drill Depth Guide



## Handpiece Connector

- Use when placing Implant with handpiece
- Spring type connection makes it easier and safer to pick-up and position Implant

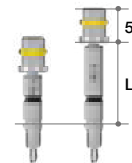
| Length (mm) | Ref.C    |
|-------------|----------|
| 5           | AROHCU25 |
| 10          | AROHCS25 |



## Ratchet Connector

- Use when placing Implant with torque wrench
- If it is not perfectly fastened, this can cause damage to inner part of mount.
- Neck part will fracture when 190Ncm torque is applied (recommended to use under 80Ncm)

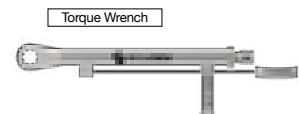
| Length (mm) | Ref.C    |
|-------------|----------|
| 10          | ARORCU25 |
| 15          | ARORCS25 |



## Torque Wrench

- 15 to 70Ncm torque can be identified, and use when placing Implants and abutment screws
- Use by connecting directly to ratchet connector when placing Implant
- When connecting abutment screw, use by connecting to insert driver

| Torque(Ncm)            | Ref.C  |
|------------------------|--------|
| 15/ 25/ 35/ 45/ 60/ 70 | TWSQ70 |



## Implant Driver

- Implant removal tool when Implant mount is damaged due to placing with higher torque than recommended

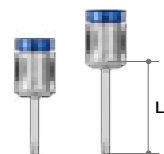
| Type    | Ref.C   |
|---------|---------|
| 2.6 Hex | ARIED26 |



## Hand Driver (1.2 Hex)

- Use for all cover screws, abutment screws, and healing abutments
- Various lengths for operator convenience
- Without separate adapter, can be used as torque driver by directly connecting to torque wrench
- Recommended torque: less than 45Ncm

| Length(mm) | Type        | Ref.C       |
|------------|-------------|-------------|
| 5          | Ultra-short | *TCMHU1200  |
| 10         | Short       | TCMHDS1200  |
| 15         | Long        | TCMHDL1200  |
| 20         | Extra-long  | *TCMHDE1200 |

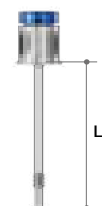


(\*) Separate sales item

## Removal Driver

- Use when mount or abutment cannot be separated from Implant
- Recommended torque: less than 45Ncm

| Length(mm) | Type       | Ref.C      |
|------------|------------|------------|
| 15         | Short      | *ARIERD20S |
| 20         | Long       | ARIERD20L  |
| 25         | Extra-long | *ARIERD20E |



(\*) Separate sales item

# II. Optional components

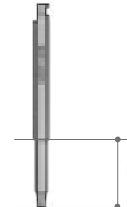
- Items not included in Surgical Kit
- Optional items can be kept in 'Option' part of Surgical Kit

## Right Angle Driver

### (1.2 Hex)

- Use for all cover screws, abutment screws, and healing abutments
- Various lengths for operator convenience
- Can be used directly connected to torque wrench without separate adapter
- Recommended torque: less than 45Ncm

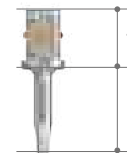
| Length(mm) | Type  | Ref.C    |
|------------|-------|----------|
| 4          | Ultra | MDR120SS |
| 10         | Short | MDR120S  |
| 15         | Long  | MDR120L  |
| 20         | Extra | MDR120EL |



## Insert Driver (1.2 Hex)

- Use for all cover screws, abutment screws, and healing abutments
- Hex tip is designed to withstand torque of 35 to 45 Ncm

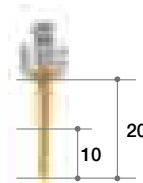
| Length(mm) | Type  | Ref.C              |
|------------|-------|--------------------|
| 10         | Short | Hex 1.2<br>MID120S |
| 15         | Long  |                    |



## Hand Tap (M1.6)

- Useful when internal screw of Implant is damaged and use for re-tapping damaged thread
- If excessive force is used during re-tapping, thread can be further damaged, so a gradual force increase is recommended

| Type | Ref.C   |
|------|---------|
| M1.6 | THT160L |



## Ratchet Wrench

- Use for applying stronger force than with handpiece
- No bearing system: no problem with drying after washing, as no damage due to corrosion
- Use by connecting to ratchet connector
- Direction of arrow engraved on head is direction in which force should be applied.

| Ref.C   |
|---------|
| MRW040S |



## Open Wrench

- Used to prevent the mount rotation when removing the implant mount from the fixture.
- Used by fixing the upper part of the implant mount.

| Length(mm) | Ref.C     |
|------------|-----------|
| 55         | ARIEOW360 |

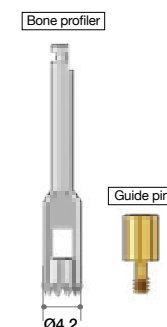


## Bone Profiler

- Guide Pin(ARIBPGP33) included.

- During the second surgery, remove excess bone around the implant platform to secure a place for the Healing Abutment or Prosthetic Abutment connection
- Each package includes a bone profiler and a guide pin.
- RC - Type coming soon

| Profile Diameter (mm) | Type | Ref.C      |
|-----------------------|------|------------|
| Ø4.2                  | NC   | ARIBP4233G |





**Can severe periodontitis patients  
have implants comfortably?**

No GBR!  
Single surgery  
and it's done!

Possible to  
deal with future  
complications  
in advance

Immediate/early  
loading is possible with  
strong initial stability

Crestal Defect to a negligible level!

**Yes, *ARi*<sup>®</sup> can!**



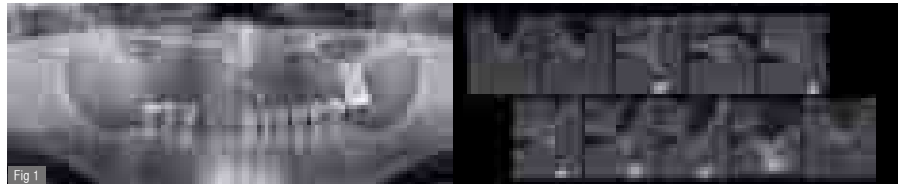
# Clinical Case

## Clinical Case 1

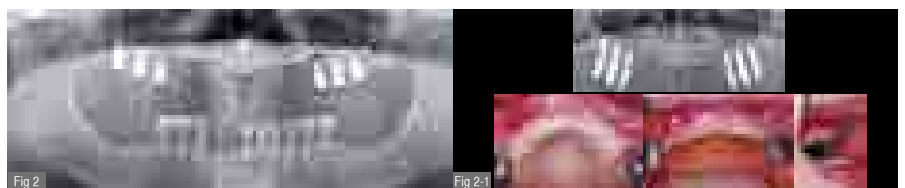
- Courtesy of Dr. Kwang-Bum Park

ARi<sup>®</sup> enables implant placement in the desired location even in an extremely thin ridge anterior region without bone augmentation, and secures sufficient fixation and stability, so there is no concern about complication treatment.

**Fig 1.** This woman in her late 50s lost almost all teeth in the maxilla and all molars on both sides of the mandible and the lower anterior teeth. This review focuses on the maxillary treatment. Both maxillary sinuses were highly pneumatized, and the anterior teeth had very thin ridges.



**Fig 2.** Due to the difficulty of implantation in the anterior region, 6 BlueDiamond implants were placed posteriorly along with sinus grafting, and the plan was for an anterior partial denture based on the posterior implants.



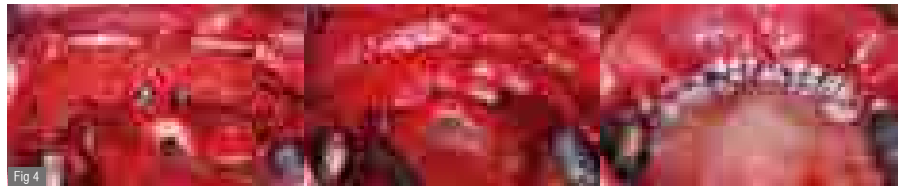
**Fig 2-1.** About 10 weeks later, when the customized abutments and PMMA temporary bridge were installed, it was decided to place maxillary anterior implants.

**Fig 3.** The thin crest after flap detachment and the depression of the part connected to the basal bone are both serious challenges for normal implant treatment

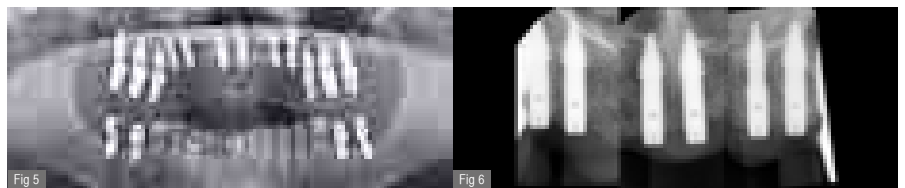


**Fig 3-1.** Normally this case would require augmentation, but ARi ((2.8)3.5X7.0(6)) implants were placed without it.

The thread part is placed inside the basal bone, while the machined, micro-grooved cuff surface is left exposed to reduce the burden of regeneration on the thin alveolar bone and minimize the possibility of peri-implantitis in the future. Should the exposed cuff be considered a bone defect requiring grafting? I don't think so, as there is no immediate worry about peri-implant bone loss or gingival recession accompanying peri-implantitis.



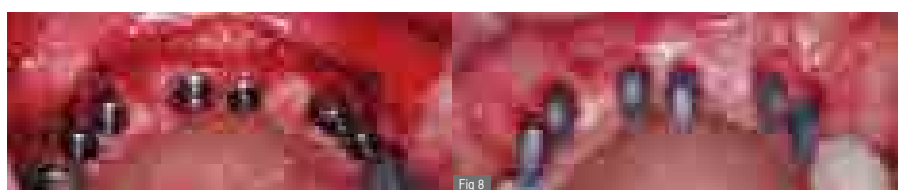
**Fig 4.** Bone Matrix I (synthetic bone) was used to create a contour that was covered with Ossix Volumax to prevent scattering of the graft during initial healing, and final suturing. No need to worry about creating 2.4mm peripheral bone.



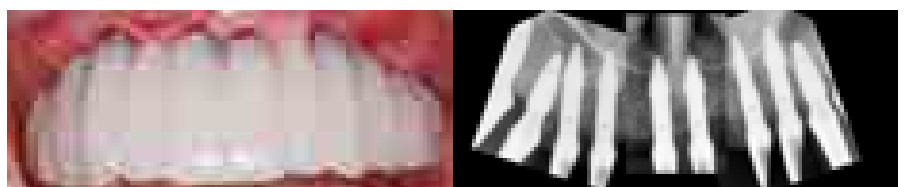
**Fig 7.** At 10 weeks, a second operation was performed using a CO2 laser, and some laser vestibuloplasty was performed to reduce the renal pool.



**Fig 8.** After attaching a TiGEN abutment, a temporary crown was loaded. The abutment attachment was confirmed via intraoral radiographs, and the soft tissue and bone reactions around the implant were satisfactory.



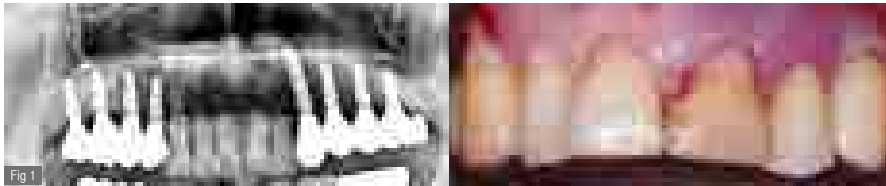
The patient almost gave up on implants and thought that she would have to live with dentures, but she was able to get temporary prosthetics. This case will be followed-up.



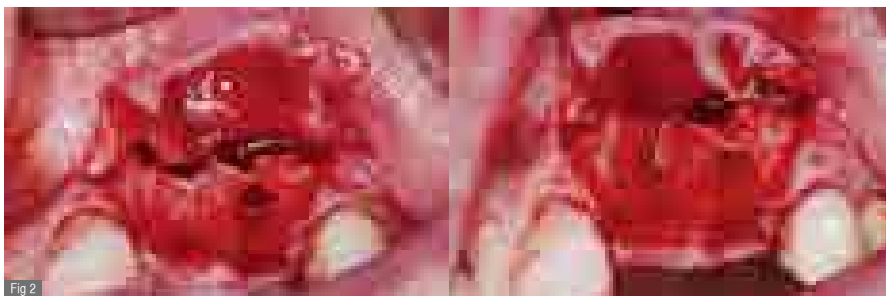
## Clinical Case 2

- Courtesy of Dr. Kwang-Bum Park

ARi<sup>®</sup> allows implants to be placed in the desired location without bone augmentation, even in large bone defect cases, and to perform immediate temporary loading. Plus, there is no gingival recession.



**Fig 1.** This woman in her late 50s wanted implant treatment due to mobility of the maxillary left central and lateral incisors as a result of severe periodontal disease. The key concerns were that implants had already been placed in canine area and whether the overall gingival line in the anterior area could be maintained or not.



**Fig 2.** In aesthetically sensitive areas, even the removal of granulation tissue needs to be carefully considered. During the incision and flap reflection, special care was taken to preserve most of the tissues. As expected, most of the labial plate had been lost at the central incisors.



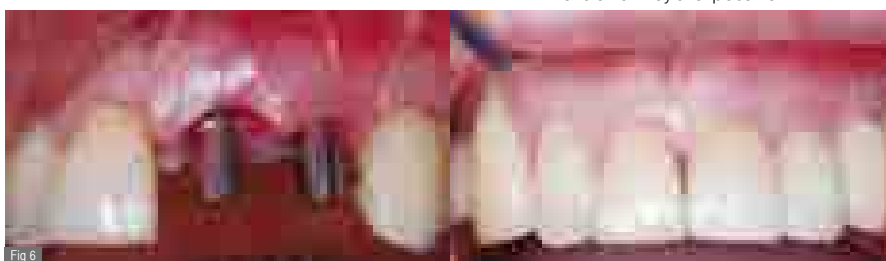
**Fig 3.** Two ARi<sup>®</sup> ((2.8)4.0\*7.0(6)) were placed at #21 and 22. The drilling measurements were as follows:  
 ① Drilling diameter (= Implant diameter of ARi<sup>®</sup>, since 3.6mm drilling was done, 2.8mm core X 4.0mm thread Implant was appropriate)  
 ② Amount drilled into healthy alveolar bone below defect (= ARi's threaded part, about 7mm)  
 ③ Height from certain upper part to crest bone of adjacent tooth (ARi's Cuff, about 6mm)

The initial stability was very high, and the thread part was placed almost completely within sound bone. The bone loss due to periodontal disease can then be treated by focusing on maintaining the gingival esthetic, instead of from the stability of the implant. The concepts of bone regeneration and gingival volume maintenance can be quite different.



**Fig 4.** Since the initial stability was very high, I decided on immediate temporization by connecting an EZ Post. This would be difficult to try with the implant systems we commonly use. For the gingiva, BCP (synthetic) was sufficient to maintain the volume and esthetic gingival line. An Ossix Plus membrane was also used to prevent scattering of the graft.

**Fig 5.** The crown of the extracted tooth was cut, made into a temporary tooth, and suturing was completed. Although this was a difficult case with significant inflammation and bone loss, it was relatively easy and satisfactorily completed.



**Fig 6.** At 10 weeks after implantation, the gingival line was not significantly different from the right anterior teeth. It is not easy to obtain such healthy gingiva in places where teeth were extracted due to severe periodontal disease. Therefore, it was exciting that the design of the implant brought this result.



**Fig 7.** Panoramic and intraoral radiographs with the final prosthesis. No gingival recession occurred, and if GBR had been performed, it is likely that complications would have occurred, but here no complications occurred.

**ARi<sup>®</sup>**  
by MEGA'GEN

